



This is a digital copy of a book that was preserved for generations on library shelves before it was carefully scanned by Google as part of a project to make the world's books discoverable online.

It has survived long enough for the copyright to expire and the book to enter the public domain. A public domain book is one that was never subject to copyright or whose legal copyright term has expired. Whether a book is in the public domain may vary country to country. Public domain books are our gateways to the past, representing a wealth of history, culture and knowledge that's often difficult to discover.

Marks, notations and other marginalia present in the original volume will appear in this file - a reminder of this book's long journey from the publisher to a library and finally to you.

Usage guidelines

Google is proud to partner with libraries to digitize public domain materials and make them widely accessible. Public domain books belong to the public and we are merely their custodians. Nevertheless, this work is expensive, so in order to keep providing this resource, we have taken steps to prevent abuse by commercial parties, including placing technical restrictions on automated querying.

We also ask that you:

- + *Make non-commercial use of the files* We designed Google Book Search for use by individuals, and we request that you use these files for personal, non-commercial purposes.
- + *Refrain from automated querying* Do not send automated queries of any sort to Google's system: If you are conducting research on machine translation, optical character recognition or other areas where access to a large amount of text is helpful, please contact us. We encourage the use of public domain materials for these purposes and may be able to help.
- + *Maintain attribution* The Google "watermark" you see on each file is essential for informing people about this project and helping them find additional materials through Google Book Search. Please do not remove it.
- + *Keep it legal* Whatever your use, remember that you are responsible for ensuring that what you are doing is legal. Do not assume that just because we believe a book is in the public domain for users in the United States, that the work is also in the public domain for users in other countries. Whether a book is still in copyright varies from country to country, and we can't offer guidance on whether any specific use of any specific book is allowed. Please do not assume that a book's appearance in Google Book Search means it can be used in any manner anywhere in the world. Copyright infringement liability can be quite severe.

About Google Book Search

Google's mission is to organize the world's information and to make it universally accessible and useful. Google Book Search helps readers discover the world's books while helping authors and publishers reach new audiences. You can search through the full text of this book on the web at <http://books.google.com/>

B 466591

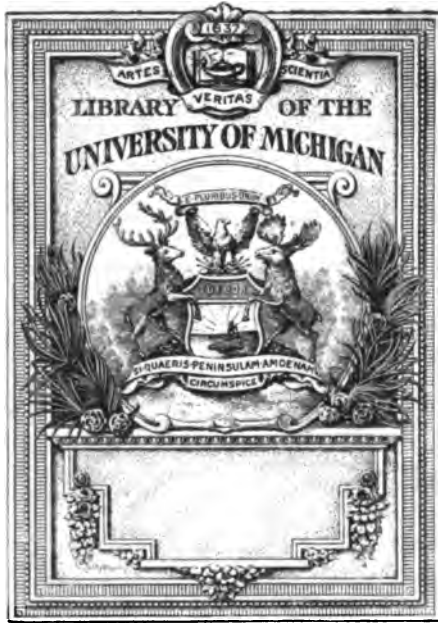

Engineering
Library

TK

5

.IG1

1904

v. 1

7/7



TRANSACTIONS

OF THE

INTERNATIONAL ELECTRICAL CONGRESS



Government Delegates, International Electrical Congress.

ST. LOUIS, 1904.

1. Herr W. Litzrodt, *Germany.*
2. Prof. Dr. S. Arrhenius, *Denmark and Sweden.*
3. Dr. R. T. Glazebrook, *Great Britain.*
4. Prof. Elihu Thomson, *United States.*
5. Prof. Moise Ascoli, *Italy.*
6. M. Guillebot de Nerville, *France.*
7. Señor Antonio Gonzalez, *Spain.*
8. Prof. H. J. Ryan, *United States.*
9. Ing. A. Maffezzini, *Italy.*
10. Dr. F. A. Wolff, Jr., *U. S. Bureau of Standards.*
11. Herr Bela Batli, *Hungary.*
12. M. Dennery, *France.*
13. Ormond Highnam, Esq., *Canada.*
14. Dr. A. E. Kennelly, *United States.*
15. Señor M. Otamendi, *Spain.*
16. John Hesketh, Esq., *Australia.*
17. Capt. Ferric, *France.*
18. Col. R. E. B. Crompton, *Great Britain.*
19. Prof. Jorge Newbery, *Argentine Republic.*
20. Prof. L. Lombardi, *Italy.*
21. Marquis Luigi Solari, *Italy.*
22. Dr. S. W. Stratton, *United States.*
23. Prof. H. S. Carhart, *United States.*
24. Prof. John Perry, *Great Britain.*
25. J. C. Shields, Esq., *India.*

PUBLISHED UNDER THE CARE OF THE
GENERAL SECRETARY AND THE TREASURER.

1905

TRANSACTIONS

OF THE

INTERNATIONAL ELECTRICAL CONGRESS

ST. LOUIS, 1904

IN THREE VOLUMES
VOLUME I

PUBLISHED UNDER THE CARE OF THE
GENERAL SECRETARY AND THE TREASURER.
1905

NOT COPYRIGHTED.

—————
PUBLICITY INVITED.

**J. E. LYON COMPANY
PRINTERS AND BINDERS
ALBANY, N. Y.**

Engineering Lib
May 8-22-47

GENERAL TABLE OF CONTENTS.

VOLUME I.

	PAGE.
ORGANIZATION OF CONGRESS..	5
PROCEEDINGS OF GENERAL MEETINGS, SEPT. 12 AND SEPT. 17.....	19
PROCEEDINGS OF CHAMBER OF DELEGATES.....	41
TRANSACTIONS OF SECTION A—General Theory.....	49
TRANSACTIONS OF SECTION B—General Applications.....	461

VOLUME II.

TRANSACTIONS OF SECTION C—Electrochemistry.....	3
TRANSACTIONS OF SECTION D—Electric Power Transmission.....	197
TRANSACTIONS OF SECTION E—Electric Light and Distribution.....	485

VOLUME III.

TRANSACTIONS OF SECTION F—Electric Transportation.....	3
TRANSACTIONS OF SECTION G—Electric Communication.....	389
TRANSACTIONS OF SECTION H—Electrotherapeutics.....	717
ROLL OF MEMBERS.....	927
LIST OF SUBSCRIBERS TO TRANSACTIONS.....	979

137931

ORGANIZATION
OF
International Electrical Congress
ST. LOUIS, 1904

THE INTERNATIONAL ELECTRICAL CONGRESS OF ST. LOUIS, 1904.

PERMANENT ORGANIZATION.

PRESIDENT:

Prof. Elihu Thomson.

HONORARY VICE-PRESIDENTS:

Prof. Dr. Moise Ascoli,	Mr. R. Kaye Gray,
Col. R. E. Crompton, C. B.,	Prof. L. Lombardi,
Dr. R. T. Glazebrook, F. R. S.,	Prof. John Perry, F. R. S.
Señor Antonio Gonzalez, C. E.,	M. Henri Poincaré.

VICE-PRESIDENTS:

Mr. Bion J. Arnold,	Prof. W. E. Goldsborough,
Prof. H. S. Carhart,	Mr. C. F. Scott,
	Dr. S. W. Stratton.

GENERAL SECRETARY:

Dr. A. E. Kennelly.

TREASURER:

Mr. W. D. Weaver.

SECTION OFFICERS.

SECTION.	HONORARY CHAIRMAN.	CHAIRMAN.	VICE-PRESIDENT.	SECRETARY.
A	Prof. Dr. S. Arrhenius.	Prof. Edward L. Nichols.	Prof. W. Lash Miller.	Prof. Howard T. Barnes.
B	Prof. G. Grassl.	Prof. C. P. Steinmetz.	W. Duddell, Esq.	Prof. Samuel Sheldon. <i>Assistant.</i> Mr. D. B. Rushmore, Mr. W. I. Slichter.
C	Prof. Dr. W. Ostwald.	Prof. Henry S. Carhart.	M. Alfred Dennery.	Mr. Carl Hering. <i>Assistant, Mr. S. S. Sadtler.</i>
D	Ing. A. Maffezzini.	Mr. Chas. F. Scott.	Ing. E. Jona.	Dr. Louis Bell.
E	Señor Miguel Otamendi.	Mr. John W. Lieb, Jr.	Prof. Jorge Newbery.	Mr. Gano S. Dunn. <i>Assistant, Mr. G. Facchioli.</i>
F	Mr. G. J. van Swaay.	Dr. Louis Duncan.	M. Marius Latour.	Mr. A. H. Armstrong.
G	John Heskeith, Esq. H. E. Harrison, Esq.	Mr. Francis W. Jones.	M. Ferrié, J. G. Shields, Esq.	Mr. Bancroft Gherardi.
H	Prof. J. A. Bergonié.	Dr. William J. Morton.	M. G. de Neville.	Mr. William J. Jenks.

Assistants to General Secretary at St. Louis,
Mr. J. A. Moyer, Mr. S. E. Whiting.

Assistants to Treasurer at St. Louis,
Mr. J. R. Cravath, Mr. D. P. Fowler.

OFFICIAL REPRESENTATIVES APPOINTED TO THE CHAMBER OF
GOVERNMENT DELEGATES.

<i>Argentine Republic:</i>	<i>Hungary:</i>
Dr. Jorge Newbery.	Herr Joseph Vater,
<i>Austro-Hungary:</i>	Herr Bela Gati.
Prof. Charles Zipernowsky.	<i>Italy:</i>
<i>Australian Colonies:</i>	Prof. Dr. Moise Ascoli,
John Hesketh, Esq.	Prof. L. Lombardi,
<i>Canada:</i>	Ing. A. Maffezzini,
Ormond Higman, Esq.	Marquis Luigi Solari.
<i>Denmark and Sweden:</i>	<i>India:</i>
Prof. Dr. Svante Arrhenius.	J. C. Shields, Esq.
<i>France:</i>	<i>Mexico:</i>
M. Poincaré,	Señor Rafael P. Arizpe.
M. Ferrié,	<i>Spain:</i>
M. Paul Janet,	Antonio Gonzalez, C. E.,
M. Guillebot de Nerville,	Miguel Otamendi, C. E.,
M. Dennery.	<i>Switzerland:</i>
<i>Germany:</i>	Prof. Ferdinand Weber.
Kaiserlich Postrat W. Litz-	<i>United States:</i>
rodt.	Prof. H. S. Carhart,
<i>Great Britain:</i>	Dr. A. E. Kennelly,
Col. R. E. Crompton, C. B.,	Prof. H. J. Ryan,
Dr. R. T. Glazebrook, F. R. S.	Prof. S. W. Stratton,
Prof. John Perry, F. R. S.	Prof. Elihu Thomson.

DELEGATES TO THE CONGRESS AT LARGE FROM CO-OPERATING
SOCIETIES.

<i>The Royal Society of London:</i>	<i>Soc. Internationale des Elec-</i>
Dr. R. T. Glazebrook,	<i>triciens:</i>
Prof. John Perry.	Prof. J. A. Bergonié,
<i>The Institution of Electrical</i>	M. Marius Latour.
<i>Engineers:</i>	<i>Associazione Elettrotecnica Ital-</i>
Mr. R. Kaye Gray, Pres.,	<i>iana:</i>
Col. R. E. Crompton, C. B.,	Prof. M. Ascoli, Pres.,
Prof. John Perry, F. R. S.,	Prof. G. Grassi, Vice-Pres.,
Dr. R. T. Glazebrook, F. R. S.,	Prof. L. Lombardi, Vice-
Mr. H. E. Harrison, B. Sc.,	Pres.,
Mr. W. Duddell, <i>Hon. Secry.</i>	Ing. E. Jona.
<i>of Delegation.</i>	

Oesterreicher Elektrotechnischer Verein:

Herr Baron Wolfgang
Ferstel.

Royal Institution of Netherland Engineers:

Mr. C. J. van Swaay.

Royal Society of Canada:

Prof. W. Lash Miller,
Prof. Howard T. Barnes.

American Institute of Electrical Engineers:

Mr. Ralph D. Mershon,
Prof. M. I. Pupin,
Prof. C. P. Steinmetz.

American Electrochemical Society:

Prof. W. D. Bancroft,
Prof. H. S. Carhart, Pres.,
Dr. Louis Kahlenberg.

National Electric Light Association:

Mr. George Eastman,
Mr. G. Ross Green,
Dr. F. A. C. Perrine.

Association of Edison Illuminating Companies:

Mr. W. C. L. Eglin,
Mr. L. A. Ferguson,
Mr. Gerhard Goettling.

American Physical Society:

Prof. A. G. Webster, Pres.,
Dr. Carl Barus,
Prof. D. B. Brace.

International Association of Municipal Electricians:

Mr. W. H. Bradt,
Mr. F. C. Mason,
Mr. Walter M. Petty.

Northwestern Electrical Association:

Mr. T. F. Grover, Pres.,
Mr. William Goltz.

Pacific Coast Electric Transmission Association:

Prof. F. G. Baum,
Dr. F. A. C. Perrine.

American Electrotherapeutic Association:

Dr. Russell Herbert Boggs,
Dr. Charles R. Dickson,
Dr. W. J. Herdman.

The United States War Department:

Major Samuel Reber, U. S.
A.

The United States Navy Department:

Lieut.-Commander Joseph
L. Jayne, U. S. N.

HISTORY OF THE ORGANIZATION OF THE CONGRESS.

The International Electrical Congress of St. Louis was initiated by President D. R. Francis of the Louisiana Purchase Exposition at the solicitation of the Director of Congresses of the Exposition, Mr. H. J. Rogers.

Letters of appointment to the committee of organization were issued by President Francis on the 1st of June, 1903, to some 30 prominent members of the American Institute of Electrical Engineers.

The committee of organization held its first meeting at Niagara Falls on the 1st of July, 1903, at which meeting the following organization was unanimously adopted:

PRESIDENT:

Elihu Thomson.

VICE-PRESIDENTS:

B. J. Arnold,	Prof. W. E. Goldsborough,
Prof. H. S. Carhart,	C. F. Scott,
Dr. S. W. Stratton.	

GENERAL SECRETARY:

Dr. A. E. Kennelly.

TREASURER:

W. D. Weaver.

ADVISORY COMMITTEE:

B. A. Behrend,	Dr. W. J. Morton,
C. S. Bradley,	Dr. E. L. Nichols,
J. J. Carty,	Prof. R. B. Owens,
A. H. Cowles,	Dr. F. A. C. Perrine,
Prof. F. B. Crocker,	Prof. M. I. Pupin,
Dr. Louis Duncan,	Prof. J. W. Richards,
H. L. Doherty,	Prof. H. J. Ryan,
R. A. Fessenden,	William Stanley,
W. J. Hammer,	Prof. C. P. Steinmetz,
Carl Hering,	Dr. L. B. Stillwell,
C. P. Matthews,	J. G. White,
R. D. Mershon,	A. J. Wurtz.
K. B. Miller,	

FINANCE COMMITTEE.

J. G. White, Chairman; J. J. Carty, H. L. Doherty, W. Stanley,
W. D. Weaver.

The following division of the work of the Congress into sections was also adopted:

General Theory:	Section A,	{	Mathematical,
			Experimental.
Applications:	{	Section B,	General Applications,
		" C,	Electrochemistry,
		" D,	Electric Power Transmission,
		" E,	Electric Light and Distribution,
		" F,	Electric Transportation,
		" G,	Electric Communication,
		" H,	Electrotherapeutics.

The second meeting of the committee of organization took place on the 18th of September, 1903, at Niagara Falls, and a general plan of procedure was adopted. The general secretary was instructed to issue invitations to join the Congress among all interested in electricity or its applications.

The following is a copy of the letters of invitation issued:

I beg to inform you that it is proposed to hold an International Electrical Congress at St. Louis in September, 1904, in connection with the Universal Exposition of St. Louis. The particulars concerning this Congress, in so far as it has been possible up to this time for the committee of organization to outline them, are given on the accompanying sheet.

The programme includes securing from selected authors, in Europe, America, and other parts of the world, many important papers for reading and discussion in each and all of the various sections of the Congress, thereby presenting collectively the most recent progress of the world in the sciences, applications, and arts of Electricity and Magnetism. The papers with discussions thereon, are subsequently to be printed, forming one, or perhaps two, large octavo volumes, and constituting a most valuable addition to scientific and technical literature.

You are respectfully invited to become a member of the Congress, and to signify your acceptance of this invitation upon the enclosed postal card. Such acceptance of membership will entitle each member to receive, by mail, a copy of the Transactions of the Congress when printed, and, if present in person at St. Louis, the member will be entitled to admission to any or all meetings of the Congress, or its sections, with the privilege of participation in their proceedings.

The fee for membership in the Congress has been fixed at five dollars (\$5.00), the proceeds to be expended in stenographic and other expenses incident to the conduct of the Congress, and in printing the Transactions.

An early reply signifying your intention to become a member will be greatly appreciated.

Each letter of invitation included a copy of the following preliminary programme:

In connection with the Universal Exposition of St. Louis, in 1904, commemorating the Louisiana Purchase by the United States, it is proposed to hold an International Electrical Congress.

The last International Electric Congress was held in 1900, in conjunction with the Universal Exposition at Paris. The last preceding International Electrical Congress in the United States was held in 1893, in connection with the World's Fair at Chicago. Electrical Congresses held in the past have had an important influence on the world's progress in the knowledge of Electricity and Magnetism, and in the application of these Sciences. It is confidently expected that the International Exposition of 1904, at St. Louis, may be equally successful in these directions.

The date set for the International Electrical Congress of St. Louis, is the week 12th to 17th September, 1904 (inclusive). This is the week preceding the session of the great Scientific Congress appointed by the Universal Exposition. On this account many of those who attend the International Electrical Congress will probably remain to attend the International Congress of the Arts and Sciences.

In accordance with the present plan, members arriving via New York will be enabled to reach St. Louis via Niagara Falls on Sunday, September 11th. Members will also be invited to attend the dedication ceremonies of the National Bureau of Standards at Washington. It is hoped that arrangements may be completed whereby the President of the United States may then meet the members.

On the morning of September 12th, at 11 A. M., a general convocation of the International Electrical Congress will be called. On the four succeeding days, from the 13th to the 16th, inclusive, meetings of the eight

sections of the Congress will be held simultaneously. On the final day, September 17th, a second general convocation will be called. Members returning from St. Louis to New York may elect to stop off at Chicago and at Niagara Falls.

As at present proposed, the International Electrical Congress will comprise three distinct features:

1st. A Chamber of Delegates, appointed by the various Governments, and essentially similar to the Chambers of Government Delegates at the International Electrical Congresses of Chicago in 1893, and of Paris in 1900. It would seem that sufficient material has been collected since 1900, calling for International action, to warrant inviting the various Governments to appoint Delegates, as before, to the International Electrical Congress of St. Louis.

2nd. The main body of the Congress, divided into the following sections:

- | | | | |
|-----------------|------------|----------------------|----------------------------------|
| General Theory: | Section A, | } | Mathematical,
Experimental. |
| Applications: | Section B, | { | General Applications, |
| | " C, | | Electrochemistry, |
| | " D, | | Electric Power Transmission, |
| | " E, | | Electric Light and Distribution, |
| | " F, | | Electric Transportation, |
| | " G, | | Electrical Communication, |
| | " H, | Electrotherapeutics. | |

It is proposed to invite prominent men in various parts of the world to contribute special papers on subjects represented in the various sections and their subdivisions.

3rd. Conventions simultaneously held, in connection with the Congress, by various electrical organizations in the United States. It is proposed that each section of the Congress may be able to hold its meeting under some plan of conjunction with the organization or organizations devoted to the progress of the work selected by that section. Steps have already been taken to enlist the sympathy of the various organizations, with a view to perfecting the details of co-operation at a later date. Prominent among the organizations from whom co-operation is expected are:

- The American Institute of Electrical Engineers,
- The American Electrochemical Society,
- The National Electric Light Association,
- The Association of Edison Illuminating Companies,
- The Pacific Coast Transmission Association,
- The American Electrotherapeutic Association.

It is also hoped to secure the participation of American scientific societies.

The Universal Exposition at St. Louis has signified its intention of affording ample facilities for the accommodation of the Congress in its halls on the grounds of the Exposition.

The committee of organization of the Congress is as follows:

PRESIDENT, Elihu Thomson.

VICE-PRESIDENTS:

B. J. Arnold,	Prof. W. E. Goldsborough,
Prof. H. S. Carhart,	C. F. Scott,
Dr. S. W. Stratton.	

GENERAL SECRETARY:
Dr. A. E. Kennelly.

TREASURER:
W. D. Weaver.

ADVISORY COMMITTEE.

B. A. Behrend,	Dr. W. J. Morton,
C. S. Bradley,	Dr. E. L. Nichols,
J. J. Carty,	Prof. R. B. Owens,
A. H. Cowles,	Dr. F. A. C. Perrine,
Prof. F. B. Crocker,	Prof. M. I. Pupin,
Dr. Louis Duncan,	Prof. J. W. Richards,
H. L. Doherty,	Prof. H. J. Ryan,
R. A. Fessenden,	William Stanley,
W. J. Hammer,	Prof. C. P. Steinmetz,
Carl Hering,	Dr. L. B. Stillwell,
C. P. Matthews,	J. G. White,
R. D. Mershon,	A. J. Wurtz.
K. B. Miller,	

The plans of the Committee of Organization are to invite *all interested* in electricity and its applications to accept membership in, and to attend the Congress if possible; to convene the Congress during the week set aside by the Universal Exposition for that purpose (12th to 17th September); to report the meetings of the Congress; and to publish the Transactions subsequently, each member of the Congress to receive a complete copy thereof.

About 14,000 copies of the programme and letter of invitation were issued prior to the meeting of the Congress.

On October 13, 1903, Prof. Elihu Thomson, president of the committee of organization, appointed a chairman and a secretary to each of the sections according to the following schedule:

SECTION.	SUBJECT.	CHAIRMAN.	SECRETARY.
A	General Theory.	Prof. E. L. Nichols, Cornell University.	Prof. H. T. Barnes, McGill University.
B	General Applications.	Prof. C. P. Steinmetz, Schenectady.	Prof. Samuel Sheldon, Brooklyn.
C	Electrochemistry.	Prof. H. S. Carhart, Univer. of Mich.	Mr. Carl Hering, Philadelphia.
D	Electric Power Transmission.	Mr. C. F. Scott, Pittsburg.	Dr. Louis Bell, Boston.
E	Electric Light and Distribution.	Mr. J. W. Lieb, Jr., New York.	Mr. Gano S. Dunn, New York.
F	Electric Transportation.	Dr. Louis Duncan, Mass. Inst. Technol.	Mr. A. H. Armstrong, Schenectady.
G	Electric Communication.	Mr. F. W. Jones, New York.	Mr. B. Gherardi, New York.
H	Electrotherapeutics.	Dr. W. J. Morton, New York.	Mr. W. J. Jenks, New York.

All of the gentlemen thus nominated accepted their appointments, and freely contributed their time and services to the work of the Congress. They largely attended meetings of the committee of organization. They made the final selection of the names of authors to be invited to read papers at the Congress. They attended all of the sessions in St. Louis during the Congress week. Moreover, the section secretaries prepared, at their own expense, translations of all papers in foreign languages which were received prior to the Congress convention.

Invitations to co-operate with the Congress were issued on behalf of the committee of organization to all the leading electrical societies and institutions of the world.

At the instance of the section officers, 350 letters were addressed to prominent electrical workers in all parts of the world, inviting papers for presentation at the Congress.

In November, 1903, an application was made to the State department at Washington, through the Secretary of Commerce and Labor, requesting that foreign governments be invited to appoint official representatives to the Chamber of Delegates of the Congress. The application was supported by a petition from the president of the American Institute of Electrical Engineers. This application was granted, and on Dec. 17, 1903, instructions were issued by the State department to the United States embassies abroad to forward the invitations for appointments according to the following list, following the precedents of the Chicago and Paris Congresses:

	Delegates invited.		Delegates invited.
Great Britain	5	Portugal	1
France	5	British North America	1
Germany	5	Australian Colonies	1
Austro-Hungary	5	India	1
United States	5	Japan	1
Belgium	3	China	1
Italy	3	Mexico	1
Russia	3	Brazil	1
Switzerland	3	Chili	1
Denmark	2	Peru	1
Holland	2	Argentine Republic	1
Spain	2		—
Norway and Sweden	2	Total	56

The following countries responded to the appeal by appointing representatives to the Chamber of Delegates:

	Delegates.		Delegates.
Great Britain	3	Denmark and Sweden	1
France	5	Spain	2
Germany	1	British North America	1
Austro-Hungary	1	Australian Colonies	1
United States	5	India	1
Italy	3	Mexico	1
Hungary	2	Argentine Republic	1
Switzerland	1		—
		Total	29

In order to aid the Secretary of Commerce and Labor in selecting the United States Delegates, a mail ballot was cast by the members of the committee of organization for five nominations. The nominees of this ballot were confirmed by the executive committee and the list forwarded to the Secretary of Commerce and Labor. The appointment of these nominees was made by the Secretary on July 5, 1904.

Meetings of the committee of organization were held in New York on the 23d April, and 16th August, 1904, at which the business of the Congress was reported and resolutions taken in regard to the conduct of the same.

The following scientific and technical societies accepted the invitation to co-operate with the Congress by the appointment of delegates: (See pages 8 and 9.)

- The Royal Society of London.
- The Royal Society of Canada.
- The American Physical Society.
- The Institution of Electrical Engineers.
- The American Institute of Electrical Engineers.
- La Société Internationale des Electriciens.
- Oesterreicher Elektrotechnischer Verein.
- Royal Institution of Netherland Engineers.
- Associazione Elettrotecnica Italiana.
- The American Electrochemical Society.
- The National Electric Light Association.
- The Association of Edison Illuminating Companies.
- The Pacific Coast Transmission Association.

The Northwestern Electrical Association.
The International Association of Municipal Electricians.
The American Electrotherapeutic Association.

The Congress met in St. Louis during the week 12th to 17th September, 1904. The number of adhesions by the end of the week was 2046. The number of registrating members attending was 719. The number of papers read at the Congress was 158. Of these 99 were in printed form and were distributed at the meetings. The remainder were received too late to be printed in advance and were read either from MSS. or by title.

PROCEEDINGS
OF
GENERAL MEETINGS
OF THE
International Electrical Congress
ST. LOUIS, 1904

Monday, September 12 and Saturday, September 17

(19)

**Proceedings of General Meetings of the International Electrical
Congress St. Louis, 1904**

GENERAL MEETING, MONDAY, SEPTEMBER 12, 1904.

The opening convention of the International Electrical Congress was held at the Coliseum Music Hall, St. Louis, Mo., 12th September, 1904, and was open to the public as well as to the membership.

Prof. Elihu Thomson, president of the committee on organization, called the meeting to order at 10 o'clock and said:

It is a great gratification, gentlemen, to announce that we have with us to-day the president of the Exposition, President David R. Francis, whom I have the pleasure of introducing to you. President Francis has to make an address at another congress soon after his address here, and we will therefore dispense with all formality in the preliminary business with which the congress was to have been opened.

Mr. Francis: Mr. Chairman and Members of the International Electrical Congress.—As president of the Universal Exposition now in progress in St. Louis, I have been asked to extend to you a welcome to this city. I appreciate the honor very highly, and regret that my engagements are such that I can not remain with you during your entire session of to-day, and, in fact, during all of your sessions to which I might be granted admission. The character of this international congress is such as to commend it not only to the greatest consideration of the management of this universal exposition, but also from the municipality of St. Louis, from our state government and also from the national government, because our government has recognized this Congress, as have the governments of many foreign countries, by appointing delegates to represent those countries and this government at this meeting of the Congress.

This Universal Exposition, gentlemen, is a very ambitious scheme, as you know. Any attempt to assemble the best products of the human race in any special line of human endeavor is ambitious; but when an undertaking is planned to comprise the assembling of the best products of every line of human endeavor, it becomes almost colossal in its proportions. We, who have been engaged in this movement from its inception, have seen it grow in its plan and scope from day to day and week to week, and we must confess that at the beginning we hardly realized the magnitude of the work. It would be presuming upon the part of the management for us to attempt to prejudice you as to the character and comprehensiveness of the exhibits that have been assembled at this Exposition. We leave it to you to pass judgment yourselves upon the Exposition when you have given as much time to its inspection as your engagements will permit. I think it will be a long time, in this country at least, before another universal exposition is attempted. There will, of course, be international expositions in special lines, and the line which you represent is the one in which there is likely to be another international exposition before many more years have rolled by. The great advances which have been made in the science to which you have given allegiance has rendered more than interesting any assembling of the different appliances and any demonstration of the different inventions and discoveries that have been made by the members of this Congress or by the members of allied organizations.

There was some discussion in the organization of this Exposition, as to whether electricity was entitled to recognition as a separate department. There was a claim made by the department of machinery that electrical appliances, when made instruments of utility, became machinery, and consequently belonged to the department of machinery, and that there was no more occasion or necessity for a department of electricity than for a department of steam. I believe that those of you who will see the department of electricity which has been installed at this Exposition will admit that the action of the administration of the exposition in determining that electricity should not only be a separate department, but should have the exclusive use of a large exhibition palace, was a wise conclusion.

It would be presuming on my part to attempt to dwell on the advances that have been made in electricity in recent years in ad-

dressing such an audience as this. I am sure, however, that you will pardon the presumption in a layman, when he expresses the opinion that the development in this line has hardly begun. The installation in the electrical department in this Exposition is, in the judgment of the management, superior to any installation that has ever been given in any exposition. It is the result of the very faithful and intelligent efforts of the chief of the department of electricity. In so comprehensive an organization as a universal exposition, you can readily understand that there must be a number of men who are trusted to do many things without consulting any higher authority. The organization which has brought about this exposition has been in existence about five years. The inception of the movement dates back five years—six years, I may say—but the first three years of that time were devoted to promotion work, so that the organization of the company proper does not date previous to March, 1901. For three years prior to that time there were some of us in this city who were agitating the question of the celebration of a great event in the history of the United States. That agitation took shape in the form of an exposition.

After Congress had recognized this celebration by appropriating \$5,000,000 to aid in its inauguration, a local company was formed, which company had charge of the movement from that time forward. In organizing the local company, the work was divided into four great divisions—division of works, division of exhibits, division of exploitation, and the division of concessions and admissions. The division of exhibits is under the control of a director, under whom are fifteen chiefs of departments. We congratulate ourselves on the classification of these exhibits. You, gentlemen, who are readers and thinkers, know how difficult it is to make a comprehensive working classification that will include all the products of all the civilized countries on the globe. One of the departments of that division of exhibits, one of the great departments of that classification, is *electricity*.

We might call electricity the new science. The discoveries that are being made in it from day to day will no doubt necessitate another classification or sub-classification before the next exposition is held, whether that exposition will be universal, or whether it be limited to an international exposition of electricity.

The wisdom that has been exercised by the organizers of this Congress, and by those who have kept it in existence from month to

month, indicates a great breadth of view, and a remarkable foresight in regard to the development of electricity. The different branches of this Congress all demonstrate how far-reaching are the discoveries in electricity.

St. Louis is glad to be made the scene of your fifth congress. The Exposition Management feels honored that the time and place of your meeting should have been influenced by the preparations that were made by the Exposition for the purpose of bringing together the best products of all the peoples of the world. Permit me, on behalf of the Exposition Management, to express the hope that your deliberations may come fully up to your expectations; that you may visit the Exposition exhibit of electricity; that your gathering here may be prolific not only of pleasure to yourselves, but that it may also result in still further advances along the line of progress which you have pursued with such remarkable vigor and success during the last decade. I would that I could stay and listen to the remarks that I understand will be made by the members of your organization, but an engagement for an hour which is already passed, to open a congress on the grounds of the exposition, compels me to take my departure. I, therefore, will close by again thanking you for meeting in St. Louis, and by expressing to you the hope that you may visit the Exposition as often as your engagements will permit, that you will remain with us as long as you possibly can, and that when you return to your homes, the recollection of this Exposition may induce you to come again individually, as well as to advise all of your friends to visit us. I thank you, gentlemen.

Chairman Thomson: We will now proceed to the work of opening the Congress. The committee on organization substantially finishes its work on this occasion. It is, perhaps, well to recall at this time a little of our past history. The four hundredth anniversary of the discovery of America was celebrated in 1893 by the establishment of a great exposition. The Chicago International Electrical Congress, the work of which is doubtless familiar to many of those present to-day, was the first great gathering of electrical students and workers held in the Western hemisphere. A little over one hundred years ago the then youthful but ambitious republic of the United States of America acquired from France, by the expenditure of \$15,000,000 purchase money, the possession of an enormous territory extending from the shores of the Gulf of

Mexico, west of the Mississippi river, northward and westward to the Pacific Coast. The northern limit was undefined, and was settled long after by treaty with Great Britain. The tract includes every variety of land—farm, forest, semi-arid and arid land. Much of the arid land is amenable to irrigation. The agricultural and mineral wealth is beyond estimation. The Louisiana purchase must be regarded as an event not less important than any other in the history of this great nation, fitly to be celebrated after one hundred years by a great exposition, showing the results of human activity and progress in the arts, sciences and engineering—and might I add, especially in electrical science and engineering—the first in the new century just begun.

It was natural that an international electrical congress should have been deemed desirable. Accordingly, a committee on organization was called together by the exposition authorities. The committee in undertaking the work realized that the task was not a light one, and invoked the aid of the American Institute of Electrical Engineers and of the other societies which have affiliated themselves with the Congress. The work of the committee of organization is completed by this meeting, and the choice of permanent officers is now in your hands. I cannot, however, close this short statement without a warm tribute to the work of the secretary, Dr. Kennelly, who has given time and effort without stint to every phase of the development of the Congress. Neither can I fail also to remind the Congress that the diligence, care and good judgment of the treasurer, Mr. Weaver, of the *Electrical World and Engineer*, has also been invaluable. He has been a pillar of strength at all times.

I wish also to express our deep sense of the assistance and encouragement arising from the assurances of cooperation received from the various scientific and technical bodies which are represented here to-day.

Col. Samuel Reber: Mr. President, I move that the Chair appoint a committee of three to report the nominations of Congress officers for permanent organization. (Motion seconded and carried.)

Chairman Thomson: I will appoint as such committee Colonel Reber, chairman, Prof. Perry and Prof. Lombardi, and request that the committee will immediately begin its deliberations on this very important subject.

Prof. H. S. Carhart: Mr. President, I move that a committee

of three be appointed by the chair to nominate honorary officers of this convention. (Motion seconded and carried.)

Chairman Thomson: I have pleasure in appointing Prof. Carhart, chairman, and Mr. W. D. Weaver and Mr. Carl Hering, as the committee to nominate honorary officers of the Congress.

I now have the pleasure of calling upon Mr. R. Kaye Gray, President of the Institution of Electrical Engineers of Great Britain, to respond on behalf of the British institution, to the address of President Francis.

Mr. Gray: Mr. Chairman and Gentlemen.—We have all heard from President Francis as to the objects of this great Exposition. For my part, I may perhaps state to you that we, the Institution of Electrical Engineers of Great Britain, felt very much pleased when we received the invitation to go to St. Louis and to take part in the Electrical Congress. This pleasure was made all the greater when we received from our colleagues on this side of the Atlantic, the American Institute of Electrical Engineers, a cordial invitation to come to their country, and an assurance from them that we would receive a hearty welcome, and that they would charge themselves with looking after our welfare during our sojourn in your country.

There is another pleasure which we have experienced here since our arrival, and that is that we have met our colleagues from Italy. I had the very great pleasure in the spring of last year to visit with our institution the north of Italy and to witness the electrical work which was being done there. I met my friend Prof. Ascoli, whom I am very glad to see is leading the Italian contingent, visiting your shores, having also received the hearty welcome which you extended to us all, upon the occasion of our trip to Italy last spring.

When we arrived here and had placed in our hands the program which you have prepared for the Congress—I think that never has such a program been laid out before, I won't say for an electrical congress, but I will go further, and say that a program such as this has never been before laid out for any congress of a specialized nature—we were still further pleased that we had arranged to visit your shores and take part in the Congress. To those of us who have had, at various times during our career, occasion to organize meetings, though of very much smaller proportions than this Congress, can very well appreciate what an enormous amount of labor has been expended by our kind friends on this side to organize such

an extensive program as is now laid before us. We have heard from President Francis, and we have heard from Prof. Elihu Thomson, how much Dr. Kennelly and Mr. Weaver have done, but I think now that we are here, and I have command of the platform, you will allow me to break through that veil of modesty which is so well known in Prof. Elihu Thomson (applause) and to give him his due mead of praise. I can see, gentlemen, by your applause, that the venture I have made has been a perfectly justifiable one.

I do not know that I should occupy your time any longer, because my good friend Prof. Ascoli is going to have the pleasure of addressing you, but before taking my seat I wish to say, in the name of the Institution of Electrical Engineers of Great Britain, how warmly we feel toward you all in this country. I wish to say what great admiration we have for you. I can not speak of St. Louis, of course, because we only arrived yesterday afternoon, but perhaps before this Congress closes some of us will have had time to appreciate the result of the work of your committee on organization.

Chairman Thomson: Not only are we fortunate in having a splendid representation from the Institution of Electrical Engineers of Great Britain, but we have a most unusual representation from the Associazione Elettrotecnica Italiana, and it is my great pleasure now to introduce to you Prof. Ascoli, who comes at the head of the delegation.

Prof. Ascoli: Mr. President, Mr. Chairman and Gentlemen.—I have the honor, which I highly appreciate, to reply on behalf of the Italian delegates to President Francis, to Prof. Thomson, and President Gray, who have all had such kind words to say to our delegation from Italy. It is really an exceptional fact that so considerable a number of Italian engineers should join in a visit to this country. I think it is the first time that such a large delegation of Italian engineers has visited the United States. We have already had a splendid proof of the great hospitality and of the sentiments of friendship from the Americans who have entertained us during the past few days. We had the opportunity of seeing, and highly appreciating, the great results of organization, which is a special characteristic of American work. We have heard from President Francis the history, I may say, of the organization of the Exposition. We have heard from President Thomson an idea of the work done in the organization of this Congress, and we are sure that with such an organization the work

of the Congress must have most important results. I cannot speak in the English language as clearly as it would be necessary in order to express the sentiments of the Italian delegation for our American brothers on this occasion. But I hope to interpret the sentiments of my Italian colleagues to an extent sufficient to convey to you our hearty thanks for your kind welcome and our appreciation of the hard work which has been done in the organization of this Congress, and especially to Prof. Thomson, Dr. Kennelly and Mr. Weaver.

Chairman Thomson: We are happy in the example set by our British and Italian colleagues, and in case we ever hold another exhibition and congress, we hope their example may be followed by other nations. We hope that our colleagues in France may be induced to send equally large or yet larger delegations. There are other countries, too, which might easily send delegations when they get into the spirit of it. You know, however, the traditional unwillingness of the Frenchman to leave his home and fireside and travel in foreign lands; but it so happens that we have with us some representatives of the great Republic of France, and I have pleasure in calling upon M. Guillebot de Nerville to speak not only on behalf of France, but on behalf of other nations which may be represented here to a greater or less degree.

M. de Nerville then addressed the meeting in French, and expressed his pleasure in being in attendance on the Congress.

Chairman Thomson: It seems fitting on this occasion, since we meet here on the site of a great exposition, that we should have with us, and to speak to us, a gentleman who has had charge of the electrical work which is there displayed. I take pleasure in calling upon Prof. W. E. Goldsborough, of whom you have heard from President Francis, and who has taken charge of the magnificent installation of electrical exhibits, and carried it to completion in a most satisfactory manner. This installation is now open to your inspection at the fair grounds.

Prof. W. E. Goldsborough: Mr. Chairman and Gentlemen.— I can not tell you with what pleasure I welcome you to St. Louis on behalf of the electrical men of St. Louis. We feel that in coming here you have brought to us the one gift which we have prized more than all else connected with the Exposition.

It is not fair to say that the Exposition Management is in anywise responsible for the achievements in electrical engineering

which you may find at the Exposition—it is only fair to say that this International Electrical Congress (which has been developing and working to a far greater extent than possibly many of us here have knowledge of) has itself organized and placed at the Exposition the exhibit of what has been accomplished in the field of electrical engineering; and this we may take as the embodiment of the physical effort of the Congress. And I say of the Congress advisedly, because the men, the brains, the muscle, and the enthusiasm which have gone into the work at the Exposition have come from and are a part of this Congress.

There is now opening here, as I view it, a work which will be the embodiment of the mental effort of this Congress.

In Machinery Hall you will find large direct-connected generating sets of very advanced type, many of them complete installations, and in the Palace of Electricity smaller electrical machinery and apparatus which bear particularly upon the scientific side of our work. On the Exposition grounds at night there is an illumination, which some have been pleased to say is very beautiful, and which has been brought to its state of perfection, as regards its conception, by Mr. Henry Rustin. In all of these things we have but worked with what you have placed in our hands.

During the months that have gone by it has largely been the knowledge of the fact that you would be with us to enjoy the electrical features of the Exposition which has inspired us to put forth our best efforts; to make preparation for your coming. I want to say, on behalf of the Exposition Management, that President Francis, Mr. Skiff, the director of exhibits, and Mr. J. E. Smith, chairman of the electricity committee, have given me such support as I doubt any man might fairly have expected to receive from his superior officers; and anything which you do not feel that you can take to yourselves, I hope you will credit to them, as between you lies what credit there is for what has been done.

Naturally, the American engineers have appreciated more than words can express the effort that has been made by our foreign friends to meet with us and make our meeting here a truly international one in the broadest possible sense. We know of the measure of fatigue they have had to withstand, and how much they have been inconvenienced by having to focus their paths on a very distant city without reference to their own convenience. The fact that they are here in such large number is greatly appre-

ciated and I think tells the story better than it can be told in any way of the fine cooperative spirit that animates electrical workers. We have probably a better nomenclature, we probably have more uniform standards, and have our work systematized for making it of accurate record and for passing it between men of different tongues than has any other division of human endeavor. It is a matter upon which we must congratulate ourselves, and I am quite sure, as the result of your work here, we will go forward during the next decade much better equipped than ever before for the task before us.

I thank you very much for the opportunity of extending to you a welcome on behalf of the electrical men of St. Louis, and trust your visit may be one of pleasure and profit.

Chairman Thomson: We are now ready for the report of the nominating committee.

Col. Samuel Reber: I am instructed by my colleagues on the committee to report the following officers for the permanent organization:

For President, Prof. Elihu Thomson; Secretary, Dr. A. E. Kennelly; Treasurer, Mr. W. D. Weaver; Vice-Presidents, Mr. Bion J. Arnold, Prof. H. S. Carhart, Prof. W. E. Goldsborough, Mr. C. F. Scott, Prof. S. W. Stratton.

For officers of the sections, the following:

Section A: Chairman, Prof. Edward L. Nichols; Secretary, Prof. Howard T. Barnes. Section B: Chairman, Prof. Charles Proteus Steinmetz; Secretary, Prof. Samuel Sheldon. Section C: Chairman, Prof. Henry S. Carhart; Secretary, Mr. Carl Hering. Section D: Chairman, Mr. Charles F. Scott; Secretary, Dr. Louis Bell. Section E: Chairman, Mr. John W. Lieb, Jr.; Secretary, Mr. Gano S. Dunn. Section F: Chairman, Dr. Louis Duncan; Secretary, Mr. A. H. Armstrong. Section G: Chairman, Mr. Francis W. Jones; Secretary, Mr. Bancroft Gherardi. Section H: Chairman, Dr. William J. Morton; Secretary, Mr. William J. Jenks.

(Mr. R. Kaye Gray in the chair.)

Chairman Gray: Gentlemen, you have heard the list of names laid before you, by the committee on nominations, for the approval of the Congress.

Mr. Samuel Reber: I move the acceptance of the report.

(Motion seconded.)

Chairman Gray: I presume that you will endorse the report of the committee without dissent. I, therefore, ask you to pass the vote by acclamation. No objection being made, the gentlemen are elected as the officers of the Congress.

(President Thomson in the chair.)

President Thomson: I thank the gentlemen of the Congress for this endorsement of what has already been done. I can not but feel that in electing the organizing officers as the permanent officers of the Congress, without objection, without even a suggestion on the part of any one of a change in those officers who have served on the committee of organization, the work of the committee has received your endorsement. We are encouraged by that result. The duties before us will not probably be so arduous as those which are now in the past. It is usual on occasions of this kind for the president-elect to make an address. I have a few thoughts to present, and without trying your patience too much I will take this occasion to give them to you.

The main object of the Congress will have been fulfilled if there is brought out in its papers and discussions the best thought and work in the electrical field. We have no need to dwell here upon the great growth which has taken place, and is now going on, in electrical science and engineering. True it is that equally rapid advancement may be found in many fields, but electricity is unique in its almost universal character. Not only has it already made great revolution in methods of lighting, in power systems for transportation, in communication of intelligence and in many other fields of engineering, but our conceptions of the nature and workings of the forces in the universe, even the nature of matter itself are and will be profoundly affected. It is too early even to suggest that electricity will be the study of the alchemist of the future. Research in pure science seldom takes account of engineering and industrial possibilities. It is well that it is so; but from the present standpoint, the electric arc of Davy, the voltaic couple, the magneto-electricity of Faraday, the electric waves of Hertz, as examples merely, show how the results of inquiry undertaken for its own sake, may become the basis of enormous industrial development. It is fitting, therefore, that in a body of this kind science and its applications should be united.

There is, however, a difference between the work of the investigator of pure science and that of the engineer. I regard inven-

tion as creative engineering. The difference alluded to is sometimes lost sight of. It touches the matter of responsibility for results. It matters not very much whether the results reached by the former are negative or positive, whether they indicate success or failure to attain expected or unexpected results. Not so with the engineer. If he is to maintain his standing his results must be positive, his work must succeed commercially, industrially and financially. Naturally, the engineer receives or should receive emoluments in accordance with the responsibility incurred. As a result, the pursuit of science for its own sake may suffer when the scientific investigator takes up engineering. Sometimes it is engineering that suffers. It is a sign of the times that the value of research is becoming so well recognized as an aid to engineering that our large industrial organizations willingly support research work. Naturally, preference is given to such new work as promises immediate benefit to the industry. The principle is gradually coming to be recognized, however, that constant additions to knowledge of nature are in themselves valuable and likely at any time to open up new channels of industry. The little streams lead to the rivers and few rivers are without commercial possibilities.

"The ethical value of the study of science and its applications is inestimable. By it, and through it only, will fallacious systems of thought and inequitable precedent finally lose their influence and disappear from the world. Figuratively, the honest "cold light of science" is a fact. The firefly exemplifies the actual, physical cold light of the future.

The future of science, and particularly of electrical science, is boundless. The chemist must possibly accept an electrical atom, the mechanic an electrical inertia. Since the ether is only known to possess electromagnetic properties, whatever that may mean, matter and all immersed therein may be electrical. Prepare, then, to accept an electrical universe. "Who shall bring him to see that which shall be after him."

President Thomson: We will now hear the report of the committee on the election of honorary vice-presidents and honorary chairmen and vice-presidents for the various sections.

Prof. H. S. Carhart: I have the honor to report for the committee on nominations for vice-presidents, honorary chairmen and vice-presidents the following named gentlemen from abroad as

vice-presidents of this International Electrical Congress: Prof. Ascoli, Col. Crompton, Dr. Glazebrook, Senor Gonzalez, Mr. Gray, Prof. Lombardi, Prof. Perry, and Prof. Poincaré.

For the honorary chairmen and vice-presidents of the sections, we report as follows: Section A: Honorary Chairman, Arrhenius; Vice-President, Lash Miller. Section B: Honorary Chairmen, Grassi, Zipernowsky; Vice-Presidents, Duddell, Weber. Section C: Honorary Chairman, Ostwald; Vice-President, Denery. Section D: Honorary Chairmen, Janet, Maffezzini; Vice-President, Jona. Section E: Honorary Chairman, Otamendi; Vice-Presidents, Arizpe, Newbury. Section F: Honorary Chairmen, Ferstel, Van Swaay; Vice-President, Latour. Section G: Honorary Chairman, Harrison, Hesketh; Vice-Presidents, Ferrié, Shields. Section H: Honorary Chairman, Bergonié; Vice-President, de Nerville.

President Thomson: You have heard the report of the committee on honorary nominations. What is your pleasure?

Col. Reber: I move that the gentlemen named be accepted as the honorary officers of the Congress.

President Thomson: You have heard the motion just made; if there is no objection we will take the vote by acclamation. (The honorary officers were elected by acclamation.)

President Thomson: I take pleasure in declaring the Congress now open for division into sections.

The convention then adjourned.

GENERAL MEETING, SATURDAY SEPTEMBER 17, 1904.

The closing general meeting of the International Electrical Congress, held in the Hall of Congress, World's Fair, was called to order at 10:30 A. M., President Elihu Thomson in the Chair.

President Thomson: We have come to the closing meeting of the Congress, which as you know has been occupying us throughout the week, and which we hope has been entirely successful.

It is in order to make a report from the Chamber of Delegates at this session, and I beg leave to read to you the statement of the work of the Chamber. There is, of course, no vote to be taken upon this, nor is it to be acted upon in any way. It is merely presented as the result of the work of the deliberations of the Chamber of Delegates.

The report of the Chamber of Delegates was then read [see pages 45-47].

I think there are no other reports to be made to the Congress, and we now come to the closing exercises of the session. We have the good fortune, at this last moment, to have with us Prof. Henri Poincaré, of France, who has consented to address the members here.

Professor Poincaré addressed the Congress in French and gave expression to much satisfaction that the danger of unwarranted action with respect to electrical units had been averted by the Chamber of Delegates through its recommendation confining action in the matter to a commission appointed by the various governments, which commission would not sit amid the distractions of a World's Fair.

President Thomson: I should like to call on President Robert Kaye Gray, of the Institution of Electrical Engineers, for a few short remarks.

President Gray: I don't know, sir, that I can say very much on the subject except to mention that we are very happy to know the result of the deliberation of the Chamber of Delegates, because, talking from the point of view of a man dealing with electrical matters, I also feel that Prof. Poincaré has expressed the feelings of an institution such as ours. I could not for one moment criticise the action of the Chamber of Delegates, except that criticism be one of the most favorable kind. I have no doubt, gentlemen, that you all who deal with electrical matters will find that they acted in

the wisest and most correct manner in the decision they have arrived at, and that when there is constituted a central bureau to which recourse can be had, a stability will be given to the matter of units, and also certain international standards can be arrived at; but if I might express my personal feeling, I hope that when the latter question is dealt with, while the units ought to be absolutely correct — as correct as human agency can make them — yet it would be very much to be regretted if any standard should be created which would have the effect of retarding the progress of our great industry.

I thank you, Mr. President, for your kindness in calling upon me to speak, and I also thank you very much for the kindness shown to my colleagues of the Institute of Electrical Engineers at your Congress.

President Thomson: I know that gentlemen on the floor — particularly certain gentlemen, have been called upon frequently during the week to state their feelings and attitude, and if in the absence of Prof. Ascoli, the head of the delegation of Italy, Professor Lombardi will say a few words in regard to the proceedings of the Congress from his standpoint of view, we shall be indebted to him.

Prof. Lombardi: Mr. President, I was not prepared at all to speak here, but I take with very great pleasure this occasion to express my perfect accord with the conclusions of the Chamber of Delegates. I think the question of the units could not be decided better, because a permanent Committee appointed by the different governments would be a most suitable deliberating body.

I think some difficulties will arise perhaps in regard to the question of standardizing dynamo machines, etc., because of the very different conditions existing in the different countries, but I could not usefully enter into a discussion of this question now. I think it will be the duty of the Commission which will be appointed in future, to discuss this very important problem and to make proposals, after having given it their very best deliberation.

Having had the honor to come for the second time to America I have enjoyed very much the cordial reception of our American colleagues, and therefore, I take occasion to express my best thanks, — not only for myself, but also on behalf of our President, and our colleagues of Italy.

President Thomson: I had hoped we might persuade Herr Litzrodt, a representative here present from Germany, to say a few words but he refers the response to Dr. Arrhenius.

Dr. S. Arrhenius: I feel that I should take this opportunity to express thanks for the brilliant way in which this Congress has been conducted. It will surely leave on our memories ineradicable traces during our whole lives.

We all feel the deepest sentiments of admiration for the extraordinary development of the culture and of the industry of this new great power, the American Nation. There has never been in history an example of such a rapid development as this before our eyes. It has been to us all a very great pleasure and benefit to see our colleagues here, and to make their acquaintance; to find old friends whom we have met before, and to form new bonds of friendship with many others. I hope that we all feel the extraordinary good to be derived from these gatherings, and I hope we will meet again either on this side or on the other side of the great water that connects us.

I wish especially to express our thanks to the officers of the Congress, to the Local Committee, and to the American Institute of Engineers, for their great hospitality tendered to us during these days, the remembrance of which will continue during life. Some of us will yet remain here for a period, but most of us must separate in a few short hours, and for all I might express our sentiments of deepest gratitude and admiration for the officers of this Congress, and say that their work will bear fruit in the future.

As you have already heard from the lips of our illustrious President, the Chamber of Delegates has accomplished work which we hope lays the foundation stones for development to the benefit of all nations, and I will express our gratitude that this work has been done on the free American soil.

We express our best wishes for this grand nation, and hope that it may go forward uplifting the banner of harmony and of liberty as it has done in the past, to the benefit not only itself, but of the nations of the whole world.

President Thomson: As a representative of the co-operating societies who have met with us, I should like to call on Prof. Webster, of Clark University, the President of the American Physical Society, if he does not object. I know he has received no notice of this invitation.

Prof. Webster: It is quite unexpected to me, and I may say quite unnecessary. I have been attending during the past week merely as an extremely interested participant in these meetings.

Although I have no official connection with the Chamber of Delegates, yet, if it is of any advantage to them, I may say that their proceedings have my hearty approval. The more they leave things as they are, the better we shall be satisfied with them. That is my point of view, and I may say the same thing of physics. I don't share, sir, your fear, or hope, that physics is about to be swallowed up in electricity, though I think it extremely probable that everything of which the physical world is made, is made of electricity.

I would like to call your attention to the fact that the electricity is in very small pieces indeed — I may say ultra-homeopathic pieces of electricity. I may say, therefore, that we are perfectly willing to be made of electricity, and to know that whatever it is that makes us go slowly — and the Lord be praised for anything in this country to bring about this result — and that whatever there is that forms a resistance to acceleration, is made of electricity.

I don't think I can add anything to what has been said. I regret very much that I came in too late to hear Professor Poincaré, for I have been looking for him for the past week. I am perfectly sure I agree with whatever he said.

At the various dinners we have attended this week we have heard the greatest variety, or similarity I would rather say, of fraternal sentiments. I am sure I should like to associate myself with you all. I love England: my people came from England 260 years ago. I love Germany: I spent four of the happiest years of my life in Germany as a student. I love France, for I consider Paris to be the centre of the earth. I love Italy, because it is the most beautiful country I have ever seen. I love Japan, and I should like very much to go there, for I am sure it is yet more beautiful than Italy; and I wish only to say in closing that if there is anything that is going to bring the world altogether, as it has always done and always will do, it is the pursuit of science; and I should like to quote a remark made by a distinguished gentleman from the State of Massachusetts, which is my home: Edward Atkinson,— who, in an address on the application of science to the arts of war, said that every application of science and of all the sciences, to the arts of war, tends to make war more nearly impossible, and he concluded with the statement that it was only required that scientists should invent a gun which should pick off generals at headquarters with the same accuracy that the Boer sharpshooters picked off the British captains and lieutenants, to make war forever impossible. Gentle-

men, I commend that to you and to all scientists, as the most worthy of occupations — the abolishment of war through the development of science.

President Thomson: I felt sure that in calling on Professor Webster he would show a capacity for emergency work which always distinguishes him, and I am gratified to have the expression from him concerning the work of the Congress, which may be taken as representative of the views of most of us present.

Mr. J. W. Lieb, Jr.: I arise on behalf of the official delegates to, and members of, the International Electrical Congress, to propose a vote of thanks to the St. Louis Reception Committee for their hospitable entertainment while we have been in St. Louis.

President B. J. Arnold: I had no idea this motion was going to be proposed by Mr. Lieb, but I know of no man more able to make the motion. As the President of the American Institute of Electrical Engineers, I take pleasure in seconding that motion most heartily. St. Louis has treated us royally, and I have no doubt we shall take pleasure in passing it by acclamation.

President Thomson: This motion admits of no discussion. I should like to have you pass that by acclamation. (Motion put to a vote and unanimously carried.) It is my pleasure to state that the unity and harmony which has pervaded our meetings has been a source of great satisfaction to us who have had to do with the organization and control of the Congress while it has been here in St. Louis. We are grateful for the evidences of self abnegation exhibited by the members of the Congress, and the officers in control of the sections, when there was so much temptation to draw them away; so many things to see. And we know, also, that many of them, besides, have so little time that there is only a fraction of a day left before they return to the east, while others will go farther than the shore of the Atlantic ocean.

We feel that the work accomplished at this Congress will render it a memorable one, not only on account of the importance of the subjects under discussion, but also for the move that has been taken in regard to the International Commission. I have no doubt that this Commission will soon be a fact, and will then be able to take up questions which are not, or which many of us have thought are not, proper to be discussed during an exposition. It is a question, too, as to when there will be another exhibition.

It is particularly gratifying to me, as executive officer of the

Congress, to find that so much has been done by everyone connected with the Congress to render my duties as pleasant and agreeable as possible, and I thank every member of the Congress for the evidences of good will and assistance whenever it might be required.

We have come to the point of parting from those who have visited us from abroad. I don't know that their enjoyment could have been greater than ours. We regard it as great a privilege to have had them with us — a privilege unestimable; to have had the fellowship and assistance which has come to us, and without which this Congress could not certainly have accomplished anything like the valuable results which will, we hope, come from it. They have enlivened our discussion and entered heartily into every move which was made for the benefit of the Congress at large. To the foreign delegates who have been present in the Chamber of Delegates I particularly wish to say a word. I have found that the unanimity of action, the absence of any disagreement whatever, has been remarkable. As soon as a measure was known to be a proper thing, all votes were unanimous from every country. And this bodes well for future work of the International Commission.

We must part. Many of the acquaintances are new acquaintances — visitors from abroad; others are old friends. Some I have had the pleasure of meeting at the Chicago Congress. But I will say this: that though we part in body we will be together in spirit. We cannot forget this admirable occasion on which we have been able not only to enjoy having them with us, but we hope they will carry pleasant memories from us, as we part.

There is nothing more that will need to come before the Congress, I believe, and I now declare the International Electrical Congress of 1904, dissolved.

PROCEEDINGS

OF THE

CHAMBER OF DELEGATES

APPOINTED BY THE VARIOUS GOVERNMENTS TO THE

International Electrical Congress

ST. LOUIS, 1904

(41)

**Proceedings of the Chamber of Delegates Appointed by
the Various Governments to the International
Electrical Congress, St. Louis, 1904**

**MINUTES OF THE FIRST MEETING OF THE CHAMBER OF DELEGATES
OF THE INTERNATIONAL ELECTRICAL CONGRESS OF ST. LOUIS,
CALLED IN THE HOTEL JEFFERSON AT 3 P. M. ON THE 12TH OF
SEPTEMBER.**

The meeting was called to order by Prof. Elihu Thomson, President of the Congress, at 3:15 p. m.

A committee of five members was appointed to examine credentials and nominate officers for permanent organization. The committee consisted of Messrs. Ascoli, de Nerville, Gonzalez, Perry and Ryan, with Dr. Kennelly as temporary secretary.

At 3:30 p. m. the meeting of the chamber adjourned to 2:30 p. m. on the 13th day of September.

Immediately after the adjournment of the chamber, the committee of five was called to order by Prof. Perry.

The following nominations were unanimously adopted:

For President of the Chamber of Delegates, Prof. Elihu Thomson.

For Vice-Presidents, Prof. Arrhenius, Prof. Ascoli, Prof. Carhart, Dr. Glazebrook, Señor Gonzalez, Herr Vater.

The committee then adjourned.

MINUTES OF THE SECOND MEETING OF THE CHAMBER OF DELEGATES OF THE INTERNATIONAL ELECTRICAL CONGRESS OF ST. LOUIS, AT 2:30 P. M., ON TUESDAY, SEPTEMBER 13, 1904, IN THE HOTEL JEFFERSON.

Present—

Argentine Republic, Ing. Jorge Newbery.

Canada, Ormond Higman, Esq.

Commonwealth of Australia, John Hesketh, Esq.

Denmark and Sweden, Prof. Svante Arrhenius.

France, Messrs. Dennery, Ferrié and de Nerville.

Germany, Herr Litzrodt.

Great Britain, Messrs. Crompton, Glazebrook and Perry.

India, J. C. Shields, Esq.

Italy, Messrs. Ascoli, Lombardi, Maffezzini and Solari.

Spain, Messrs. Gonzalez and Otamendi.

United States, Messrs. Carhart, Kennelly, Ryan, Stratton and Thomson.

The minutes of the first meeting were read and approved. The report of the committee on credentials and nominations was read and adopted. The following organization of the chamber was, therefore, adopted:

President: Prof. Elihu Thomson.

Vice-Presidents: Messrs. Arrhenius, Ascoli, Carhart, Glazebrook, Gonzalez, Poincaré and Vater.

On motion of Prof. Carhart, Dr. Kennelly was appointed secretary, and Dr. F. A. Wolff assistant secretary.

The chair appointed the following committees to consider the subjects of International Electromagnetic Units and of International Standardization of Electrical Apparatus and Machinery, to report at the next meeting of the chamber:

Committee on international electromagnetic units: Messrs. Ascoli, Carhart, Glazebrook, de Nerville, Stratton.

Committee on international standardization: Messrs. Crompton, Gonzalez, Lombardi and Ryan.

The chamber then adjourned to 2:30 p. m., Thursday, September 15th.

**MINUTES OF THE THIRD MEETING OF THE CHAMBER OF DELEGATES
OF THE INTERNATIONAL ELECTRICAL CONGRESS OF ST. LOUIS,
AT 2:30 P. M., THURSDAY, SEPTEMBER 15, 1904, IN THE HOTEL
JEFFERSON.**

The meeting was called to order at 2:45 p. m. by President Thomson.

Present—

Argentine Republic, Ing. Jorge Newbery.

Canada, Ormond Higman, Esq.

Denmark and Sweden, Prof. S. A. Arrhenius.

France, Messrs. Dennery, Ferrié and de Nerville.

Germany, Herr Litzrodt.

Great Britain, Messrs. Crompton and Glazebrook.

India, J. C. Shields, Esq.

Italy, Messrs. Ascoli, Lombardi, Maffezzini and Solari.

Spain, Messrs. Gonzalez and Otamendi.

United States, Messrs. Carhart, Kennelly, Ryan, Stratton and Thomson.

The minutes of the second meeting were read and approved.

The following report of the committee on international electromagnetic units was accepted and unanimously adopted:

“The sub-committee appointed September 13, 1904, beg leave to suggest that the Chamber of Delegates should adopt the following report:

“It appears from papers laid before the International Electrical Congress, and from the discussion, that there are considerable discrepancies between the laws relating to electric units, or their interpretations, in the various countries represented, which, in the opinion of the chamber, require consideration with a view to securing practical uniformity.

“Other questions bearing on nomenclature and the determination of units and standards have also been raised, on which, in the opinion of the chamber, it is desirable to have international agreement.

“The Chamber of Delegates consider that these and similar questions could best be dealt with by an international commission representing the governments concerned. Such a commission might in the first instance be appointed by those countries in which legisla-

tion on electric units has been adopted, and consist of, say, two members from each country.

"Provision should be made for securing the adhesion of other countries prepared to adopt the conclusions of the commission.

"The Chamber of Delegates approves such a plan, and requests its members to bring this report before their respective governments.

"It is hoped that if the recommendation of the Chamber of Delegates be adopted by the governments represented, the commission may eventually become a permanent one."

The following report was also received, and unanimously adopted, from the committee on international standardization.

"The committee of the Chamber of Delegates on the standardization of machinery, begs to report as follows:

"That steps should be taken to secure the cooperation of the technical societies of the world, by the appointment of a representative commission to consider the question of the standardization of the nomenclature and ratings of electrical apparatus and machinery.

"If the above recommendation meets the approval of the Chamber of Delegates, it is suggested by your committee that much of the work could be accomplished by correspondence in the first instance, and by the appointment of a general secretary to preserve the records and crystallize the points of disagreement, if any, which may arise between the methods in vogue in the different countries interested.

"It is hoped that if the recommendation of the Chamber of Delegates be adopted, the commission may eventually become a permanent one."

The chamber then adjourned to meet at 2:30 p. m., Friday, September 16, 1904.

MINUTES OF THE FOURTH MEETING OF THE CHAMBER OF DELEGATES OF THE INTERNATIONAL ELECTRICAL CONGRESS OF ST. LOUIS, AT 2:30 P. M., FRIDAY, SEPTEMBER 16, 1904, IN THE HOTEL JEFFERSON.

The meeting was called to order at 2:40 p. m. by President Thomson.

Present—

Argentine Republic, Ing. Jorge Newbery.

Canada, Ormond Higman, Esq.

Commonwealth of Australia, John Hesketh, Esq.

Denmark and Sweden, Prof. Svante Arrhenius.

France, Messrs. Dennery, Ferrié and de Nerville.

Germany, Herr Litzrodt.

Great Britain, Messrs. Crompton, Glazebrook and Perry.

Hungary, Herr Gati.

India, J. C. Shields, Esq.

Italy, Messrs. Ascoli, Lombardi, Maffezzini and Solari.

Spain, Messrs. Gonzalez and Otamendi.

United States, Messrs. Carhart, Kennelly, Ryan, Stratton and Thomson.

The minutes of the third meeting were read and approved.

The following resolutions were unanimously adopted:

“That the delegates report the resolution of the chamber, as to electrical units, to their respective governments, and that they be invited to communicate with Dr. S. W. Stratton (Bureau of Standards, Washington, D. C.) and Dr. R. T. Glazebrook (National Physical Laboratory, Bushy House, Teddington, Middlesex, England) as to the results of their report, or as to other questions arising out of the resolution.”

“That the delegates report the resolution of the chamber, as to international standardization, to their respective technical societies, with the request that the societies take such action as may seem best to give effect to the resolution, and that the delegates be requested to communicate the result of such action to Col. R. E. B. Crompton, Chelmsford, England, and to the president of the American Institute of Electrical Engineers, New York City.”

On motion of Dr. Glazebrook and Prof. Ascoli, a vote of thanks was extended by acclamation to President Thomson and to the officers of the Chamber of Delegates, for their services in convening and conducting the actions of the chamber.

At 3:30 p. m. the chamber adjourned *sine die*.

TRANSACTIONS

OF

SECTION A

General Theory—Mathematical, Experimental

Honorary Chairman, DR. SVANTE A. ARRHENIUS

Chairman, PROF. EDWARD L. NICHOLS

Vice President, PROF. W. LASH MILLER

Secretary, PROF. HOWARD T. BARNES

[49]

VOL. I—4

TABLE OF CONTENTS—SECTION A

	PAGE
THE MECHANICAL EQUIVALENT OF HEAT AS MEASURED BY ELECTRICAL MEANS. By Prof. Howard T. Barnes.....	53
Discussion by Dr. R. T. Glazebrook.....	66
THE ALTERNATING-CURRENT THEORY OF TRANSMISSION-SPEED OVER SUBMARINE CABLES. By Dr. A. E. Kennelly.....	68
Discussion by Prof. A. G. Webster and Mr. J. S. Stone.....	105
THE THEORY OF IONISATION BY COLLISION. By Prof. J. S. Townsend..	106
SPECTRA OF GASES AT HIGH TEMPERATURES. By Prof. J. Trowbridge..	122
ON THE SYSTEMS OF ELECTRIC UNITS. By Prof. Moise Ascoli.....	130
PROPOSALS CONCERNING ELECTRICAL AND PHYSICAL UNITS. By Prof. G. Giorgi	136
THE ABSOLUTE VALUE OF THE ELECTROMOTIVE FORCE OF THE CLARK AND THE WESTON CELLS. By Prof. H. S. Carhart and Prof. G. W. Patterson, Jr.....	142
THE SO-CALLED INTERNATIONAL ELECTRICAL UNITS. By Dr. F. A. Wolff	148
Discussion on the papers of Ascoli, Giorgi, Carhart and Patterson and Wolff, and upon the general subject of Electromagnetic Units, by Dr. R. T. Glazebrook, Prof. A. G. Webster, Prof. H. S. Carhart, Mr. H. E. Harrison, Dr. A. E. Kennelly, Prof. John Perry, Dr. F. A. Wolff, Dr. C. H. Sharp, Dr. G. W. Patterson and Mr. W. Duddell. Communi- cation by Dr. K. E. Guthe.....	170
THE ELECTRIC ARC. By Prof. C. D. Child.....	191
Discussion by Prof. H. T. Barnes, Prof. H. Crew and Prof. B. F. Thomas	203
THE ABSOLUTE MEASUREMENT OF INDUCTANCE. By Dr. E. B. Rosa and Mr. F. W. Grover	205
Discussion by Dr. C. V. Drysdale.....	231
THE RELATION BETWEEN MASS AND WEIGHT FOR RADIUM. By Prof. J. J. Thomson, F. R. S.....	234
Discussion by Prof. E. Rutherford.....	241
COHERER ACTION. By Dr. K. E. Guthe	242
Discussion by Prof. B. F. Thomas.....	255
RECENT ADVANCES IN THE ANALYSES OF THE EARTH'S PERMANENT MAGNETIC FIELD. By Dr. L. A. Bauer.....	256
Discussion by Dr. R. T. Glazebrook and Dr. C. P. Steinmetz..	271
ON THE ELECTRIC CHARGE OF THE SUN. By Prof. S. Arrhenius.....	274
Discussion by Dr. L. A. Bauer, Dr. C. P. Steinmetz and Prof. E. Rutherford	281

	PAGE.
SLOW TRANSFORMATION PRODUCTS OF RADIUM. By Prof. E. Rutherford	285
Discussion by Prof. W. D. Bancroft and Prof. F. B. Thomas.	301
LORENTZ'S THEORY OF ELECTRICITY. By Prof. A. G. Webster.....	302
ELECTRIC CONDUCTION IN METALS FROM THE STANDPOINT OF THE ELECTRONIC THEORY. By Prof. Dr. Paul Drude.....	317
ELECTRICAL STANDARDS. By Dr. W. Jaeger.....	331
MAGNETOSTRICTION. By Prof. H. Nagaoka.....	343
SECONDARY STANDARDS OF LIGHT. By Prof. J. Violle.....	357
CONDENSATION NEUGLEI. By Prof. C. T. R. Wilson.....	365
CONCERNING NATURAL RADIO-ACTIVITY OF THE ATMOSPHERE AND THE EARTH. By Profs. J. Elster and H. Geitel.....	375
THE ELECTRICAL CONDUCTIVITY OF GASES. By Prof. E. P. Lewis.....	385
THE RADIOACTIVITY OF MINERAL OILS AND NATURAL GASES. By Prof. J. C. McLennan	398
ELECTROSTRICTION. By Prof. Louis T. More.....	423
THE UNOBTAINED WAVE-LENGTHS BETWEEN THE LONGEST THERMAL AND THE SHORTEST ELECTRIC WAVES YET MEASURED. By Prof. E. F. Nichols	438
THE MAGNETIC EFFECT OF MOVING CHARGES. By Dr. H. Pender.....	443
<i>Total number of papers presented before Section A, 27.</i>	

Section A was called to order at 11 a. m., Monday, 12th of September, Prof. Edward L. Nichols presiding.

CHAIRMAN NICHOLS: The first paper on the programme this morning is that of Dr. Guthe, and as Dr. Guthe is not in the room at the present moment I will call for the second paper on the list, by Prof. Howard T. Barnes, "The Mechanical Equivalent of Heat Measured by Electrical Means."

Prof. H. T. BARNES: This paper is more or less a continuation of the previous papers which I have contributed to the Royal Society and elsewhere, on "The Mechanical Equivalent of Heat as Measured by Electrical Means."

THE MECHANICAL EQUIVALENT OF HEAT MEASURED BY ELECTRICAL MEANS.

BY PROF. HOWARD T. BARNES, *McGill University.*
Delegate of the Royal Society of Canada.

No physical constant illustrates so clearly the uncertainty existing in the values of the electrical units as the mechanical equivalent of heat measured by electrical means. This is very well shown in the very complete report to the Paris Congress of 1900 by Prof. J. S. Ames. Much has been done to reduce the errors by the discovery of the discrepancy in the absolute value of the Clark cell. But there still remain certain small deviations between the values deduced by the best electrical means and between these and the values obtained by the direct-mechanical methods. The classical work of Rowland and of Reynolds and Moorby leave little room for improvement on the mechanical measurements and especially may we regard it so since it has been shown how well these two investigations accord with each other.

In the present paper it is desired to discuss, as completely as possible, the most probable value of the mechanical equivalent in terms of the generally accepted values of the electric units. At the same time it is desired to leave it in such a form that whatever decision is arrived at by this Congress as to the values of these units, a correction may be made to the final result.

PREVIOUS OBSERVERS.

Of all the previous investigators using electrical means, we need only mention the work of Griffiths, Schuster and Gannon, and Callendar and Barnes. Prof. Ames has given a most complete summary of the subject up to the time of the Paris Congress and since then no fresh material has been contributed than was included in that report and the annexed report by Prof. E. H. Griffiths on the Specific Heat of Water.

Griffiths and Schuster and Gannon used essentially the same method which was that of Joule with the mechanically developed heat replaced by suitable electrical means. Callendar and Barnes

used a continuous-flow electrical method, which has been already fully described, and which is radically different from the method of Joule. Rowland used the method of Joule, while a continuous-flow method was adopted by Reynolds and Moorby. This gives us measurements of the mechanical equivalent, both mechanical and electrical, by the two methods of calorimetry.

VALUES OBTAINED BY THE DIRECT-MECHANICAL METHODS.

*Joule.*¹ The value now accepted as given from Joule's classical experiments is 4.173 joules in terms of a thermal unit at 16.5 degs. C. This is expressed for a temperature interval measured on the nitrogen thermometer. Many corrections, which later improvements in calorimetry have shown it necessary to apply, are so large that very little weight can be attached to this value. Historically, however, the work is of the greatest importance and the general method devised by Joule has been the basis for the best determinations.

*Rowland.*² The work of the late Prof. Rowland is without doubt one of the best direct determinations which has been made. These results extend over an interval of temperature between 5 degs. and 35 degs. C., although the measurements at the extremes of the range are not entitled to the same weight as those at the ordinary temperature. The uncertainty of the corrections become very great at the extremes of the range, but this was fully understood by Rowland. The values given in the original memoir have been corrected by others as various improvements in thermometry were made.

The recalculation and corrections made by Waidner and Mallory³ are probably the most accurate. The results quoted by these gentlemen are given in the following table:

Rowland's Values of the Mechanical Equivalent Corrected by Waidner and Mallory.

10°	4.195 joules.
15°	4.187 "
20°	4.181 "
25°	4.176 "
30°	4.175 "
35°	4.177 "

1. *Phil. Trans.*, 1878.

2. *Proc. Am. Ac.* 15, 75 (1879-80).

3. *Phys. Rev.* 8, 193 (1899).

The values between 15 degs. and 25 degs. are the most accurate, and although a minimum value of the specific heat was indicated at 30 degs., Rowland did not lay much stress on the exact position of this point on account of the uncertainty of the corrections.

To quote his own words*: "The point of minimum cannot be said to be known, though I have placed it provisionally between 30 degs. and 35 degs., but it may vary from that There may be an error of a small amount at that point (30 degs.) in the direction of making the mechanical equivalent too great, and the specific heat may keep on decreasing to even 40 degs."

*Reynolds and Moorby.*⁵ A very elaborate and exhaustive series of experiments has been made by these authors to determine, by a direct-mechanical method, using a Reynolds' brake and a steam engine, the energy required to raise water from the freezing to the boiling point. The value of the mean-mechanical equivalent which they obtained is entitled to a great deal of weight, from the minute accuracy of their measurements and the careful discussion of possible sources of error.

This value, which represents the energy required to heat a standard mass of water between two standard intervals of temperature, is 4.1832 joules.

VALUES OBTAINED BY THE ELECTRICAL METHODS.

*Griffiths.*⁶ The method adopted by Griffiths was essentially that of Joule and Rowland with a few minor changes, introducing electrical means of generating heat. In order to produce as large a temperature rise as possible, a minimum amount of water was used with very vigorous stirring. This had the disadvantage of bringing up the correction for heat generated by stirring to a large percentage of the total heat supply.

An attempt was made to determine the variation of the specific heat of water between 15 degs. and 25 degs.

The values obtained by Griffiths were:—

15°	4.198 joules.
20°	4.198 "
25°	4.187 "

4. *L. O.* p. 199.

5. *Phil. Trans.*, 1897.

6. *Phil. Trans.*, 1893.

*Schuster and Gannon.*⁷ A similar electrical method was almost simultaneously applied by Schuster and Gannon. Small temperature intervals of 2 to 3 degs. were used with larger masses of water. This reduced the size of the stirring and cooling corrections, but increased the uncertainty in the temperature measurements.

Only one value was obtained, which was 4.1905 at 19.1 degs. C.

*Callendar and Barnes.*⁸ A continuous method of electrical calorimetry was originally devised by Callendar and applied by Callendar and Barnes, and by Barnes, to determine the variation of the specific heat of water. Preliminary results were obtained for water and mercury (B. A. Report, Toronto, 1897). A set of results for the variation of the specific heat of water was published in the B. A. Report for 1899 at the Dover meeting. Subsequent results, verifying the preliminary readings and extending the temperature interval to 100 degs. from the freezing point, were published in 1900 and 1902.

In this method it was possible to reduce all the corrections to a negligible amount compared with the total heat supply and the only heat loss to be considered, radiation, was eliminated by the method of calculation. The values obtained are contained in the following table:—

Temperature ° C.	
5°	4.2105 joules.
10°	4.1979 “
15°	4.1895 “
20°	4.1838 “
25°	4.1801 “
30°	4.1780 “
35°	4.1773 “
40°	4.1773 “
45°	4.1782 “
50°	4.1798 “
55°	4.1819 “
60°	4.1845 “
65°	4.1870 “
70°	4.1898 “

7. *Phil. Trans.*, 1895.

8. *Phil. Trans.*, 1902.

Temperature ° C. (Continued.)		
75°	4.1925	joules.
80°	4.1954	"
85°	4.1982	"
90°	4.2010	"
95°	4.2038	"
<hr/>		
Mean.....	4.18876	"

It at once becomes apparent, on comparing the values of the mechanical equivalent obtained by the electrical methods with the values obtained by the direct-mechanical methods, that a decided error exists in some of the units chosen for calculation. This has been very carefully discussed by W. S. Day, Waidner and Mallory, Barnes and Ames, and it has been shown that the Clark cell value used in all the calculations is in error. Fresh determinations of the Clark cell value by the absolute electro-dynamometer have shown this to be true, and it has been found necessary to reduce the original value 1.434 volts at 15 degs. C.

The value so far obtained for the Clark cell are as follows:—

Rayleigh and Sedgwick.....	1.4342
Kahle	1.43285
Carhart and Guthe	1.4333

At present it is a question which of these two last values should be accepted.

The mechanical equivalent, as measured by Griffiths and by Schuster and Gannon, requires the lower value to be brought into accord with the direct-mechanical method, or Equivalent *M*, as we shall designate it, compared with Equivalent *E*, which we shall use to designate the mechanical equivalent measured by electrical means. On the other hand the value of Equivalent *E* obtained by Callendar and Barnes requires the higher and last value.

Immediate attention should be given to this fundamental constant. The value of the ohm is far better known than the other constants. Ayrton and Jones obtained a somewhat lower value of *R* by the McGill University "Lorenz" apparatus, but until this is verified by a more elaborate research little weight can be given to the result.

A comparison of the values of Equivalent E , obtained by Griffiths and by Schuster and Gannon, with the values obtained by Barnes, show considerable discrepancy. Even when expressed in the same value of the units used, there is a wide divergence.

Although no direct comparison was made between the Clark cells used by these investigators, yet it is unlikely that the difference can be ascribed to this. The cells used by Barnes were checked by a comparison with the Cadmium cell and were found to give a value of the ratio agreeing very closely with the Reichsanstalt values.

It is possible to compare the values of the Equivalent E , obtained by Barnes, with the Equivalent M , obtained by previous observers, on account of the great range of the electrical experiments. Extending from 0 to 100 degs., it is possible by taking the average value to compare directly with the experiments of Reynolds and Moorby, and at the same time check the result by a comparison on the same curve with Rowland between 6 degs. and 36 degs. C. With such evidence as can be deduced by this comparison it seems likely that we have a very close value of Equivalent E , and at the same time a fairly close agreement between the mechanical and electrical units.

SPECIFIC HEAT OF WATER AND THE SELECTION OF THE THERMAL UNIT.

On account of the variation of the specific heat of water the selection of the thermal unit for the determination of Equivalent E becomes a matter of vital importance. Many units have been recommended, such as the freezing point, point of maximum density, room temperature and average unit between 0 degs. and 100 degs. It is now obvious from the rapid drop in the specific heat in the neighborhood of the freezing point, that the two former units are not possible. The unit at room temperature is more useful provided we can give sufficient reasons for selecting any particular room temperature. The average specific heat is used considerably and has several points to recommend it. It so happens that the average specific heat is very close to the value at 16 degs. C. and this fact led the writer to make the recommendation in a letter published in the report of E. H. Griffiths before the Paris Congress, that 16 degs. be selected as the temperature for defining the thermal unit. Sometime previously Griffiths had recommended a

unit at 15 degs. C., since some of his experiments had led him to believe that the average specific heat was not far from this. Callendar recommends a unit of 20 degs. as being more practical and giving a temperature mean about that used in self-regulating thermostat work. It seems to the writer a matter of some importance to hold to the average unit and more particularly as it is so nearly coincident with a unit at room temperature and independent of any temperature scale. The difference between the unit at 16 degs. and that at 20 degs. is only 1 part in 1000 and can readily be corrected if required in very accurate work. Griffiths in his later writings¹⁰ recommends a unit at 17.5 degs. C., but this seems to be more of a compromise than otherwise.

Of course should the variation curve for the specific heat of water in the writer's experiments be wrong at either end of the scale, some error would be introduced in the mean.

Callendar, in discussing this question in his paper on "Continuous Electric Calorimetry,"¹¹ rejects all of the writer's later work above 60 degs., and recommends the temperature formula which was deduced from the preliminary observations at the lower point, published in the B. A. Report of 1899. This temperature formula brought the curve parallel to the well-known curve of Regnault for the specific heat at the higher temperatures. There is every reason, however, to place confidence in the observations obtained by the continuous method above 60 degs., for they were taken with the greatest possible care and checked with one another to 1 part in 10,000. Moreover, particular pains were taken to eliminate sources of error, and all the conditions were as perfect as they might ever be expected to be. In fact, neglecting these observations and accepting the formula of Callendar would be allowing an error of over 1 part in 1000 at 90 degs. in the observations, which is exceedingly unlikely.

Callendar says, on page 142 of his memoir: "Although the agreement of the four observations is so perfect amongst themselves, it is possible they may be affected by a constant error of this order of magnitude (1 part in 1000), if all the difficulties of the work are rightly considered." He refers then to a linear formula which had

9. *Phil. Trans.*, 1893.

10. "Thermal Meas. of Temp." (Camb.)

11. *Phil. Trans.*, 1902.

been once suggested by the writer as fitting the observations on the higher range approximately and says, "the linear formula cannot represent the probable increase in the rate of variation of the specific heat at higher temperatures, which is theoretically required to account for the vanishing of the latent heat at 360 degs. C., the critical temperature."

The writer never intended a linear formula to be more than a convenient working formula for the higher points, and deduced a parabolic formula which represents the observations with great accuracy between 55 degs. and 100 degs. C. This curve is so nearly the same as the curve of Regnault as to be within the limits of error of the latter's observations by the method of mixtures. It seems to the writer more advisable to retain the direct-observational evidence for the higher points, as the conditions of the experiments were all so perfect.

Moreover, to bring the observations of Rowland into closer agreement with Reynolds and Moorby requires not a more rapid increase at the higher points, but one slightly less rapid. However, the difference between the means, taking the original formula in the B. A. report and that deduced directly from the observations, is not large, but is in the direction of separating the mechanical measurements.

COMPARISON OF EQUIVALENT M AND EQUIVALENT E .

Much interest is attached to a careful comparison of the work of Reynolds and Moorby and of Rowland by reference to the variation curve of the specific heat obtained by the electrical method.

If we take the curve between 5 degs. and 95 degs. we find that the mean Equivalent E thus obtained is equal to 4.18876 joules in terms of the Clark cell value 1.4342-Int. volts and true ohm equal to 1.01358-B. A. unit, while Reynolds and Moorby's value of mean Equivalent M is 4.1832. Between 6 degs. and 36 degs. this value is 4.1834 joules from Rowland's corrected results and 4.1872 by the electrical experiments. Taking the variation curve as being correct, this gives the error in the two cases as follows: From Rowland, +.091 per cent, and from Reynolds and Moorby, +.132 per cent, a difference of less than 1/2000. If we take the mean from the electrical experiments, including the observations at 0 degs. and at 100 degs., the error is slightly increased. In Rey-

nolds and Moorby's experiments the inflow temperature varied from 32.5 degs. F. to 34 degs. F. and the outflow from 210 degs. F. to 214 degs. F. If we take a mean from the electrical results we must take it from about 1 deg. to 100 degs. C. This increases the mean value by .06 per cent and reduces the temperature at which the value is equal to the mean to 14 degs. C. instead of 16 degs. It has been shown by a selected method of mixtures¹² that the specific heat of water increases in a regular way below zero. We may safely determine on the values near 0 degs. C. without extrapolation. At 100 degs. it is necessary to extrapolate a little, but the curve is so regular that there can be no error involved. This increase in the mean value of .06 per cent does not affect the comparison with Rowland's work. Taking then the total error involved on the assumption of the Clark cell equal to 1.4342 volts, we find it to be $.132 + .060 = .192$, while in Rowland's experiments it was .091. This is a difference between the two values of Equivalent M of exactly 1 part in 1000. Although this is larger than one would hope to get, it is just the limit of error claimed by Rowland for his several determinations. When one considers the difficulty and uncertainty attending the experiments by Joule's method at the extremities of the range, it is not surprising to find a discrepancy of this magnitude. If we take the mean error involved in the comparison between Equivalent E and Equivalent M which is seen to be .141 per cent and calculate the Clark cell value on the assumption that the ohm is correct, we obtain the value 1.4332 volts. This is in agreement with Carhart and Guthe's value, which is 1.4333 to 1 part in 14,000.

We may assume, as a result of this comparison, that the work of Reynolds and Moorby and of Rowland is in agreement to 1 in 1000. Whether this discrepancy is real or whether due to some fundamental difference in the methods used remains yet to be shown. It is exceedingly important to find that they are in as close agreement as they are.

12. *Phys. Rev.* 15, 65 (1902).

COMPARISON OF THE ELECTRICAL MEASUREMENTS OF THE EQUIVALENT.

On comparing the absolute value of Equivalent E , obtained by Griffiths, Schuster and Gannon, and Callendar and Barnes, it is at once apparent that a considerable difference exists. When reduced to the same value of the Clark cell, the two former measurements are brought into close accord and are both higher by 2 parts in 1000 than the results by the continuous flow method. It is impossible to say where the error lies. It may be admitted that no direct comparison was made between the Clark cells used by the writer and those used in the English investigations. It is unlikely that any serious difference existed, however, for a comparison of the English cells with the German showed no error of this magnitude and both Griffiths' cells and those used by Schuster and Gannon did not differ essentially from the Cambridge standard. The cells used by the writer were checked several times by comparisons with Cadmium cells and the values of the ratio so obtained came 1.40658 and 1.40666 which are in absolute agreement with the German standards and so indirectly with the English. There can be no possible room to doubt the resistance standards, since the writer possessed for comparison and standardizing his resistances 11 English standards, each with a signed certificate, and 1 German standard. The difference in Equivalent E by the modified method of Joule and by the continuous method is more likely due to the radical difference in the methods of calorimetry.

It may be questioned whether the separate determinations of the cooling effect by a special experiment and its subsequent application as a correction to calorimetric experiments such as is adopted in Joule's method can be relied on for an accuracy even as great as 1 part in 1000. This is about the order of error in previous calorimetric work carried out with a care that seems to warrant much better agreement. By the continuous method of calorimetry the radiation loss, which corresponds to the cooling correction, varied a great deal, and unless it had been carefully eliminated by the method adopted in carrying out the experiments, it would have produced large errors. In the writer's opinion the cooling correction is much more uncertain than has been realized before. From a careful consideration of the various experimental conditions in the writer's experiments,¹³ it is evident that

13. *Phil. Trans.*, 1902.

between glass surfaces at least changes occur which modify the value of the heat radiation. Although the surfaces may remain the same over short intervals of time, they may change over long, and particularly when changes of temperature intervene. An inspection of the summary of the values of the radiation loss, given by the writer on page 253 of his original paper, illustrates the changes, both temporary and gradual, that took place in an hermetically sealed glass vacuum jacket.

When we compare the experiments of Rowland and those of Reynolds and Moorby, we find that the difference amounts to 1 part in 1000, in the same direction as that between the electrical method similar to Rowland's and the continuous method similar to Reynolds and Moorby. This seems to be evidence of some error in either of the two standard methods, as yet to be determined.

Whatever may be said in regard to the absolute value of the electrical measurements by the continuous method, the variation curve remains unaffected, yet if we assume Griffiths' or Schuster and Gannon's value of Equivalent E and work out the mean value from the variation curve, it would require a much larger correction to the Clark cell than seems justified by the absolute measurements of that quantity to bring it into accord with the mechanical measurements.

ABSOLUTE VALUE OF THE EQUIVALENT.

In obtaining the value of the mechanical equivalent which will agree most perfectly with the mechanical measurements it will be necessary to assume (*a*) the variation curve of the specific heat of water; (*b*) the absolute value of the Clark cell and the ohm. In the first assumption is involved Callendar's parabolic formula for reducing the platinum temperatures to the standard hydrogen scale, but it cannot be admitted that any error is introduced by this method of reduction. The last assumption involves the latest absolute values of these constants subject to revision.

Considering the direct determinations first, Rowland's value at 15 degs. is 4.187 joules and at 20 degs. 4.181; Rowland's mean value between 0 degs. and 100 degs. (assumption *a*) is 4.1889; Reynolds and Moorby's mean value directly determined between 0 degs. and 100 degs. is 4.1832 joules.

Considering the electrical determinations in which the Clark cell is taken as 1.43325-int. volts at 15 degs. C.; and the ohm

as 1.01358-B. A. units, Griffiths' value at 15 degs. is 4.1927, and his mean value (assumption *a*) 4.194 joules. Similarly Schuster and Gannon's value at 15 degs. would be 4.1931 and their mean value 4.195; Callendar and Barnes' values at 15 degs. and at 20 degs. are 4.1840 and 4.1783, and the average value 4.1859 between 0 degs. and 100 degs. Tabulating the results we have the following:

Observer.	Value at 15°.	Average value between 0° and 100°.
Rowland	4.187	4.189
Reynolds and Moorby.....	4.1834
Griffiths	4.1927	4.194
Schuster and Gannon	4.193	4.195
Callendar and Barnes.....	4.1840	4.1859

The average value given from Rowland's determinations would be equal to 4.189 joules also had we assumed the absolute value at 20 degs. instead of that at 15 degs. for the calculation.

Taking the values of Rowland and of Reynolds and Moorby given in the last column and averaging them we obtain 4.1861 for the mechanical equivalent of the mean calorie which is almost identical with the number 4.1859 given from the electrical determinations of Callendar and Barnes. This does not include the values given by Griffiths or by Schuster and Gannon, but it appears from a study of the table given above that both these investigators are a little too high. To bring them into accord with the direct-mechanical measurements would require a correction to the Clark cell and ohm, much larger than is justified by our present knowledge of these constants.

The value 4.186 joules in terms of the mean calorie seems to be the most probable both for the electrical and mechanical methods, and it would be advisable that this number be selected.

The following table gives the equivalent at different temperatures from 0 deg. to 100 degs. the average of which is 4.186 joules:

Temperature.	CALENDAR. and BARNES.	ROWLAND.
0° C.	4.222	—
5	4.2050	4.206
10	4.1924	4.195
15	4.1840	4.187
20	4.1783	4.181
25	4.1746	4.176
30	4.1725	4.175
35	4.1718	4.177
40	4.1718	—
45	4.1727	—
50	4.1743	—
55	4.1764	—
60	4.1790	—
65	4.1815	—
70	4.1843	—
75	4.1870	—
80	4.1899	—
85	4.1927	—
90	4.1955	—
95	4.1983	—
100	4.2012	—
Mean	4.1859	

SUMMARY.

Summarizing the facts contained in this paper we find:

(1) That the mechanical measurements of the equivalent differ by 1 part in 1000, the result by the continuous method being below that by Joule's method.

(2) That by accepting the latest values of the Clark cell and the ohm, the result by the continuous electrical method is brought into absolute agreement with the mean of the mechanical measurements.

(3) That the measurements by the electrical method of Joule give results that are too high, but the deviation from the continu-

ous electrical method is in the same direction as that shown by a comparison of the same methods applied directly.

(4) That it seems advisable to select a thermal unit which is a mean over the range between 0 degs. and 100 degs., and thus independent of any temperature scale.

(5) That the most probable value of the mechanical equivalent measured by electrical means is 4.186 joules in terms of the mean unit.

(6) That the value of the equivalent in terms of a unit at any intermediate temperature may be obtained by reference to the variation curve for the specific heat of water obtained by the continuous electrical method, and which when integrated gives a value of the equivalent equal to 4.186 joules.

Whatever changes may be made in the values of the electrical units, which are used for calculation in this paper, our conclusions in regard to the mean of the direct-mechanical measurements will remain unaffected. Thus the mechanical equivalent which we have recommended above need not be changed, for by the agreement of the electrical methods with the mechanical it is probable that we have values of the electrical units very near the truth.

DISCUSSION.

CHAIRMAN NICHOLS: This is a very valuable epitome of the work done to determine the mechanical equivalent of heat by one who has had, himself, a very important share in fixing these values. It is before you for discussion.

Dr. R. T. GLAZEBROOK: I should like to be allowed to say one or two words. It strikes me as being of interest to us, who are here assembled in this Section of this Congress, dealing with general theory, mathematical and experimental, that we should have as our first paper one that treats so fully and so completely upon a subject of such great importance to engineers and practical men. It seems to me certainly an indication of the good to be done by the work of this Congress. I think we are all deeply indebted to Professor Barnes for the paper which deals with the subject in such an admirable manner and in which he has summarized the results hitherto achieved in this direction.

With many of his results I am in complete agreement. While I thoroughly agree with him in thinking that the work of Joule must be looked upon chiefly as fraught with historic interest, I feel sure he will agree with me in saying that a study of those researches leaves on one's mind an indelible impression of the greatness of that great man.

It is fitting, too, that the fundamental mechanical experiment which is described in this paper, that of Rowland, who succeeded because he knew how to combine with the highest mathematical ability a real and

thorough practical knowledge of the needs and requirements of the engineer, should be given such consideration.

Turning now, if I may, to one or two of the details of the paper: I should like to say, with regard to page 62, that I think Professor Barnes might replace my name by that of Lord Rayleigh. As a matter of fact, the experiments he described there were not absolute experiments on my part; only a comparison of the electrochemical equivalent of silver and e.m.f. of the Clark cell. No electromechanical experiments were conducted by me with an electro-dynamometer.

Turning now to the results of the experiments, I think it is a matter for real congratulation that we should be assured on such an authority that we know the value of the mechanical equivalent of heat, to, say, one part in a thousand, and the value of that mechanical equivalent, whether it be obtained by the direct mechanical experiments of Rowland and of Reynolds and Moorby, or by the electrical experiments of Barnes. I am not able, however, entirely, to accept his explanation (I don't know that he really gives an explanation) of the difference between the results obtained by Griffiths, and Schuster and Gannon, and by himself. It seems to me that the conditions of the experiments of Griffiths and of Schuster were so very diverse, and the corrections that came in were so different in their magnitude, that we can not suppose that the whole difference turns, as I understand Professor Barnes to say, on the method of estimating these corrections and these calculations. What the real difference is it is extremely difficult to say. If we want to know the result to a higher degree of accuracy, I take it that various experiments will have to be completed with more accurate and more perfect means. Possibly some light may be shed on it by the knowledge of the behavior of Clark cells under various circumstances. It may be right to take the various Clark cells used by Griffiths and by Schuster as of somewhat different value from that used by the author. On that point it is a little difficult to express an opinion without more detailed consideration of the various facts and figures. I should like to congratulate, again, Professor Barnes on the value and interest of his paper. As he says, it combines, and combines clearly and distinctly, the results of these important researches, and whether we accept the figures given here as final or not, we have all the figures up to date on which to base our final conclusions.

CHAIRMAN NICHOLS: The third paper on the list is that by Doctor Kennelly. Doctor Kennelly will present his paper at this time.

THE ALTERNATING-CURRENT THEORY OF TRANSMISSION-SPEED OVER SUBMARINE TELEGRAPH CABLES.

BY DR. A. E. KENNELLY, *Harvard University.*

In 1855, or nearly half a century ago,¹ Sir William Thomson (Lord Kelvin), published a theory of transmission over submarine cables which has ever since been the standard of reference on this subject. The theory was developed and supplemented in parts by Stokes, Fleeming-Jenkin,² Hockin,³ A. Gray,⁴ and Heaviside.⁵

The basis of the theory given by Kelvin is quite general, but the application of the theory has been made almost entirely through considering what happens at the receiving end of a cable, after a steady e.m.f. is applied to the sending end. This has made the subject hard to understand. When alternating currents over the cable have been considered, the treatment has been complicated. The result is that there is only a very meagre working theory of cable transmission in the hands of engineers. With the exception of a few empirical formulæ, the technical knowledge of the speed of transmission of a cable is limited to the formula

$$n = \frac{10}{\tau} \text{ letters per second.} \quad (1)$$

where 10 is an empirical constant, and τ is the time-constant of the cable in farad-ohms, or seconds. This is one form of the "C. R. Law."

The C. R. law of cables, enunciated by Kelvin, has been found inapplicable to overhead landline telegraphy or telephony, and the working theory of telephony has, therefore, grown up independently of that of submarine cables, an unnatural division.

If, however, the theory of alternating-current transmission can

1. See p. 25. 2. See p. 25. 3. See p. 25. 4. See p. 25. 5. See p. 25.

safely be extended to include the case of signaling over submarine cables, then the same theory can readily cover every case of signaling over wires. Such a theory can be made not only very comprehensive, but also very easy. It is the object of this paper to outline the application of this general alternating-current theory to submarine telegraphy.

Taking first the more general case of an alternating-current circuit possessing appreciable distributed resistance, inductance, leakage and capacity, let us consider the telephone circuit formed of a pair of overhead No. 12 B. S. W. G. hard-drawn copper wires, as indicated in Fig. 1. The circuit is operated by a simple harmonic or sinusoidal e.m.f. at *A*, has a length of *L* miles or kilometers, and is closed at *B* through a known impedance. Required the system of alternating currents and voltages, as soon as the steady regime has been attained.

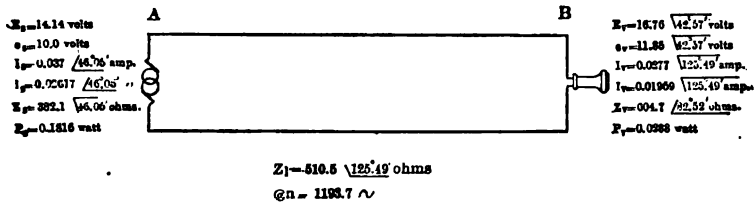

FIG. 1.—SIMPLE ALTERNATING-CURRENT TELEPHONE CIRCUIT.

Let e = the effective, or square root of mean square e.m.f. = $E \sin \omega t$ (volts).

Let E = the corresponding maximum cyclic e.m.f. = $e\sqrt{2}$ (volts).

Let ω = the angular velocity of the impressed e.m.f. (radians per second).

Let n = the frequency of the impressed e.m.f. = $\frac{\omega}{2\pi}$ (cycles per second).

Let r = the conductor resistance of the circuit (ohms per loop mile or kilometer).

Let l = the inductance of the circuit (henrys per loop mile or kilometer).

Let g = the leakance of the circuit (mhos per loop mile or kilometer).

Let c = the capacity of the circuit (farads per loop mile or kilometer).

Let $j = \sqrt{-1}$.

Let z_r = the impedance of the receiving apparatus (ohms \angle)

Let Z_1 = the "receiving-end impedance" (ohms \angle).

Let z_o = the "sending-end impedance" (ohms \angle).

Let z_s = the impedance of the circuit of the sending end (ohms \angle).

Let i = the effective current strength at receiving end (amperes \angle).

Let I_r = the maximum-cyclic strength at receiving = $i_r \sqrt{2}$ (amperes \angle).

Let i_s = the effective-current strength at sending end (amperes \angle).

Let I = the maximum-cyclic strength at sending end = $i_s \sqrt{2}$ (amperes \angle).

Then the effective, or r.m.s. current strength at A is

$$i_s = \frac{e}{z_s} = \frac{e}{z_o \left\{ \frac{z_r + \tanh(La)}{z_o} \right\}} = \frac{e}{z \tanh(La + \theta)} \quad \text{r.m.s. amperes } \angle \quad (2)$$

where α = the "attenuation-constant" $\sqrt{(r+jl\omega)(g+jc\omega)}$ (3)

L = the length of the circuit (miles or kilometers)

$$\theta = \tanh^{-1} \frac{z_r}{z_o}$$

$$z_o = \text{the "sending-end impedance"} \sqrt{\frac{r+jl\omega}{g+jc\omega}} \quad (4)$$

Again, the effective or r.m.s. strength of current received at B

$$\text{is } i_r = \frac{e}{Z_s} = \frac{e}{z_o \sinh(La) + z_r \cosh(La)} \quad \text{r.m.s. amperes } \angle \quad (5)$$

If E be substituted for e , in equations (2) and (5), we obtain I_s and I_r in place of i_s and i_r , respectively.

For example, a circuit 80 kilometers long (49.71 miles) is formed of two No. 12 B.S.W.G. hard-drawn overhead copper wires, each 0.2642 cm (0.104 in.) in diameter. It is closed at B through a telephone having a resistance of 75 ohms, and an inductance of 0.08 henry. The maximum cyclic e.m.f. acting upon the sending end A is 10 volts ($e = 10$) at a frequency $n = 1193.7 \sim (\omega = 7500$ radians per second). Find the conditions of e.m.f. and current at A and B .

Here $r = 6.2$ ohms per loop kilometer (9.98 ohms per loop-mile).

$l = 0.002274$ henry per loop kilometer (0.00366 henry per loop-mile).

$c = 0.005 \times 10^{-6}$ farad per loop kilometer (0.00805×10^{-6} farad per loop-mile).

$g = 2 \times 10^{-6}$ mho per loop kilometer (3.218×10^{-6} mho per loop-mile).

$$\begin{aligned} a &= \sqrt{(6.2 + j 17.05) (2 \times 10^{-6} + j 37.5 \times 10^{-6})} \\ &= \sqrt{18.14 / 70^\circ 01'} (37.51 / 86^\circ 57' \times 10^{-6}) \\ &= \sqrt{680.4 \times 10^{-6} / 156^\circ 58'} \\ &= 0.02608 / 78^\circ 29' = 0.005207 + j 0.02555 \end{aligned}$$

$$La = 80 \times 0.02608 / 78^\circ 29' = 2.084 / 78^\circ 29'$$

$$\sinh La = 0.9880 / 101^\circ 23'$$

$$\cosh La = 0.6257 / 142^\circ 26'$$

$$\tanh La = 1.579 / 41^\circ 03'$$

$$z_0 = \sqrt{\frac{18.14 / 70^\circ 01'}{37.51 / 86^\circ 57'}} \times 10^6 = 695.4 \sqrt{8^\circ 28'} \quad (\text{ohms})$$

$$z_r = 75 + j 0.08 \times 7500 = 75 + j 600 = 604.7 / 82^\circ 52' \quad (\text{ohms})$$

$$\frac{z_r}{z_0} = \frac{604.7 / 82^\circ 52'}{695.4 \sqrt{8^\circ 28'}} = 0.8696 / 91^\circ 20'$$

$$z_1 = 695.4 \sqrt{8^\circ 28'} \left\{ \frac{0.8696 / 91^\circ 20' + 1.579 \sqrt{41^\circ 03'}}{1 + 0.8696 / 91^\circ 20' \times 1.579 \sqrt{41^\circ 03'}} \right\} \quad (\text{ohms})$$

$$= 382.1 \sqrt{46^\circ 05'}$$

$$i_2 = \frac{e}{z_1} = \frac{10}{382.1 \sqrt{46^\circ 05'}} = 0.02617 / 46^\circ 05' \text{ r.m.s. amperes}$$

$$\begin{aligned} Z_1 &= (695.4 \sqrt{8^\circ 28'} \times 0.988 / 101^\circ 23') + (604.7 / 82^\circ 52' \\ &\quad \times 0.6257 / 142^\circ 26') \\ &= 687.1 / 92^\circ 55' + 378.3 / 225^\circ 18' \\ &= 510.5 \sqrt{125^\circ 49'} \quad (\text{ohms}) \end{aligned}$$

$$i_1 = \frac{e}{Z_1} = \frac{10}{510.5 \sqrt{125^\circ 49'}} = 0.01959 \sqrt{125^\circ 49'} \text{ r.m.s. amperes.}$$

The above computation shows that the "sending-end-impedance" of the circuit, for the frequency considered, is $695.4 \sqrt{8^\circ 28'}$ ohms. This would be the impedance offered at *A* if the circuit were indefinitely long. Reflections from *B*, when the length of the circuit is but 80 kilometers, reduce the impedance at the sending end to

382.1 $\sqrt{46^{\circ}.05}$ ' ohms. The current at *A* would be 26.17 milliamperes effective, leading the impressed e.m.f. by $46^{\circ}.05'$, and absorbing 0.1816 watt therefrom. At the receiving end the current would be 19.59 milliamperes effective, lagging $125^{\circ}.49'$; or about one-third cycle behind the impressed e.m.f. The "receiving-end-impedance" would be 510.5 $\sqrt{125.49}$ ' ohms, this being the impedance through which the impressed e.m.f. would produce the strength of current at the receiving end. The e.m.f. at *B* would be 11.85 $\sqrt{42^{\circ}.57}$ ' volts; or 18.5 per cent greater than the impressed e.m.f. and the power liberated in the telephone would be 0.0288 watt.

It is evident from the nature of this problem, and its solution, that hyperbolic trigonometry is a powerful tool in alternating-current technology. The formulæ are quite simple, and are easily remembered. If, however, an attempt is made to solve such a problem without hyperbolic trigonometry, the solution becomes appalling in extent and complexity.⁶

Hyperbolic trigonometry is the natural and simple key to the solution of problems of waves and currents over wires. In telephony and telegraphy, hyperbolic trigonometry leads to formulæ of great simplicity and power. There is, however, no need for hyperbolic formulæ in dealing with power-transmission circuits operated at ordinary commercial frequencies below 100 cycles per second. For such circuits and frequencies a simpler solution is reached by placing all the capacity in a lump or imaginary condenser at the center of the circuit. The results so derived are usually sufficiently accurate for practical purposes. For higher frequencies, however, such as are presented in telegraphy and telephony, over long circuits, the method of lumped capacity is usually unreliable, and hyperbolic formulæ must be resorted to if simple expressions and arithmetic are desired.

If the impressed periodic e.m.f. at the sending end is not simply harmonic, it may be resolved into a fundamental sinusoid with harmonic superposed ripples. Each component frequency may then be computed, as though it alone existed, and all the components summed, at any instant, to obtain the total instantaneous current.

With any assigned magnitude of impressed e.m.f. the strength of

6. See Heaviside's "Electrical Papers," London, 1892, Vol. II, p. 248. Also M. Leblanc, "Formula For Calculating the E. M. F. At Any Point Of A Transmission Line For Alternating Current." *Trans. Am. Inst. El. Engr.*, June 18, 1902. Vol. XIX, pp. 759-763.

Contrast these formulæ with the corresponding hyperbolic formulæ.

the received current depends wholly upon the "receiving-end-impedance." For a limiting working value of the received current, below which receiving becomes impracticable, the range of alternating-current transmission necessarily depends upon the receiving-end-impedance. This impedance becomes a criterion of transmission. When this impedance $Z_1 = z_0 \sinh La + z_r \cosh La$, see formula (5), exceeds a certain limiting value, the maximum available impressed e.m.f. will fail to deliver a current strength at the receiving end sufficient for requirements.

Turning now to long submarine cables in good working order, these circuits are characterized by the property that their leakance and inductance are insignificant by comparison with their resistance and capacity, so that $l = g = 0$. Consequently for such cables

$$\alpha = \sqrt{r \times j c \omega} = \sqrt{r c \omega} \quad /45^\circ \quad \text{per naut.} \quad (6)$$

$$\text{and } z_0 = \sqrt{\frac{r}{j c \omega}} = \sqrt{\frac{r}{c \omega}} \quad /45^\circ \quad \text{ohms per naut.} \quad (7)$$

Thus the "attenuation-constant" α , the "attenuated-length" La , and the "sending-end-impedance" z_0 are all affected by the angle $\frac{\pi}{4}$ or 45 deg. This simplifies the computation of the hyperbolic trigonometrical ratios, tables of which are appended.

Under the conditions employed in cable telegraphy, the waves of impressed e.m.f. are rectangular (except for drop of pressure in the battery) and the waves are separated by intervals or spaces, that are approximately of the same duration as the individual waves or e.m.f. impulses. Successive rectangular e.m.f. waves are sometimes of the same sign, and sometimes of opposite signs, according to the signals being transmitted. Between letters, there are extra long spaces. Between words there are yet longer spaces. These conditions depart considerably from simple alternating-current transmission. Nevertheless, it is generally admitted that the speed of signaling depends upon the speed of transmission attainable with currents due to impressed alternating rectangular e.m.f. impulses, so that if the latter theoretical problem can be solved, the former and more practical problem is immediately capable of approximate solution. The problem is, therefore, to determine the system of alternating currents on a cable subjected to an alternating impressed e.m.f. of the rectangular wave type.

If \mathfrak{E} be the cyclic magnitude ab of a rectangular e.m.f. a, b, c, d, e, f, g , Fig. 2, then it is well known that this e.m.f. is equivalent to the following harmonic series of sinusoidal e.m.f.'s.

$$\mathfrak{E} = E \sin \omega t + \frac{E}{3} \sin 3\omega t + \frac{E}{5} \sin 5\omega t + \dots \quad \text{volts (8)}$$

where $E = \frac{4}{\pi} \mathfrak{E}$ maximum cyclic volts (9)

and the fundamental sinusoid $E \sin \omega t$ has the same period as the rectangular e.m.f. That is, the fundamental sinusoidal e.m.f. has the frequency of the rectangular e.m.f., but has a maximum 27.3 per cent greater, as shown at g, A, B, C, D , in Fig. 2. The effective or r.m.s. e.m.f. of this sinusoid is 9.004 volts, or nearly 10 per cent less than the rectangular. The successive harmonics increase di-

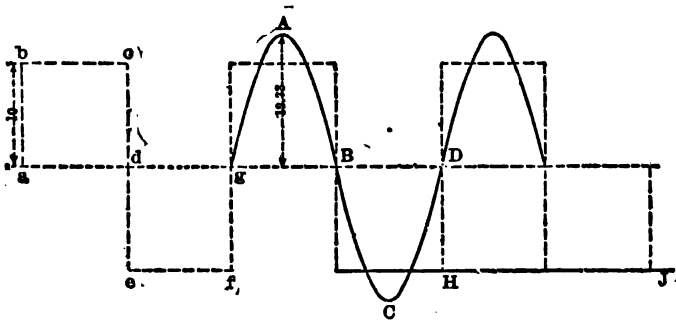

FIG. 2.—DIAGRAM OF RECTANGULAR E.M.F. AND FUNDAMENTAL SINUSOID OF THE SAME.

rectly in frequency, and inversely in amplitude, as the successive odd numbers.

If we superpose a rectangular e.m.f. of ± 10 volts upon a continuous e.m.f. of $+ 10$ volts, we obtain a rectangular e.m.f. a, b, c, d, e, f, g entirely above the zero line HJ , Fig. 2. This corresponds to "dot" impulses from $+ 20$ volts, successively followed by pauses e, f , of equal duration with the cable to ground. A succession of 20-volt dots and pauses, say four to the second, is, therefore, the equivalent of a steady application of $+ 10$ volts combined with a rectangular alternating e.m.f. of ± 10 volts. This rectangular e.m.f. would be the equivalent of the following sinusoidal e.m.f.s.:

12.73 volts maximum with the frequency 4 cycles per second.

4.244 volts maximum with the frequency 12 cycles per second.

2.546 volts maximum with the frequency 20 cycles per second.
 1.818 volts maximum with the frequency 28 cycles per second.
 1.415 volts maximum with the frequency 36 cycles per second,
 et cetera.

The current at any point in the circuit of the cable after the steady regime had been set up, with dots and pauses sent into the cable, would be the sum of a steady current from + 10 volts, and of the alternating currents from these various sinusoidal e.m.f's., each acting independently.

In determining the current strength of the cable at or near the sending end, a number of these frequencies must be taken into account. At the receiving end, however, when the frequency of dot-signaling is such as to approach the maximum practicable rate of signaling, it is only necessary to compute the first term in the series, or the fundamental frequency, because the succeeding terms all vanish. In other words, nothing is received at the distant end of a cable, when the frequency approaches the maximum, except the sinusoidal current of fundamental frequency.

The problem of determining the maximum speed of dot-signaling over a cable-conductor thus consists in finding the receiving-end-impedance Z_1 of the circuit, including the receiving apparatus, and the maximum available impressed e.m.f. at the sending end. When the minimum readable amplitude of sinusoidal received signals is known, and the corresponding current strength which will produce this amplitude, the receiving-end-impedance is immediately determined. The maximum frequency of the impressed rectangular e.m.f.; i. e., the number of dot-signals per second, is that which leads to the development of the critical receiving-end-impedance for the particular cable considered. Knowing in this way the highest available dot-frequency of the cable, the frequency of the mixed dots and dashes of practical signaling should be empirically determinable.

The receiving-end-impedance is

$$Z_1 = z_0 \sinh La + z_r \cosh La \quad \text{ohms } \angle \quad (10)$$

So that the maximum cyclic amplitude of the received current is

$$I_r = \frac{\frac{4}{\pi} \text{ } \square}{z_0 \sinh La + z_r \cosh La} \quad \text{amperes } \angle \quad (11)$$

When the impedance z_r of the receiving instrument may be neglected, the receiving-end-impedance becomes

$$Z_1 = z_0 \sinh La \quad \text{ohms } \angle \quad (12)$$

In most practical cases, however, the impedance of the receiving instrument has a marked influence upon the amplitude of the received signals, and cannot be neglected.

At the values of La which are presented in the neighborhood of

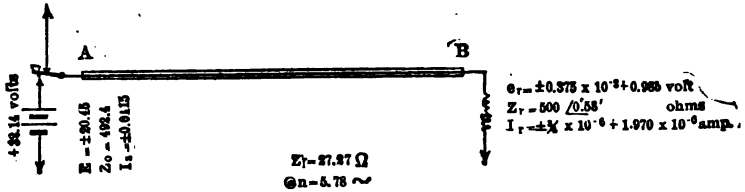

FIG. 3.— ATLANTIC CABLE WITH NO CONDENSERS.

the highest practicable frequency, it will be found that $\sinh La = \cosh La$ very nearly; so that

$$Z = (z_0 + z_r) \sinh La \quad \text{ohms } \angle \quad (18)$$

That is the receiving-end-impedance is the hyperbolic sine of the attenuated length of the cable, times the sum of the sending-end and receiving-instrument-impedances.

For example, let a cable circuit be considered for which some

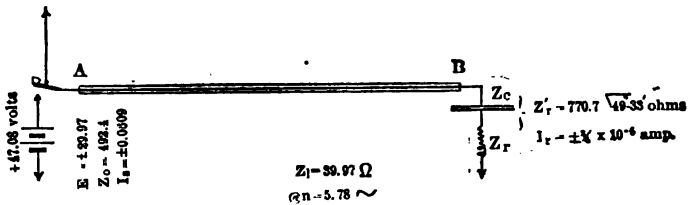

FIG. 4.— CONDENSER OF 50 MICROFARADS AT RECEIVING END.

data have been published. The 1883 Penzance-Canso Atlantic Cable is stated to have a length L of 2518 nauts, a conductor-resistance r of 3.041 ohms per naut, and a capacity c of 0.3728×10^{-6} farad per naut.

This corresponds to a total resistance of 7657 ohms, a total capacity of 939×10^{-6} farad, and a time-constant of 7.19 seconds. It is stated to carry 19 5-letter code-words per minute. The average 5-letter word contains 36.59 dot-elements; so that the cable would carry 693.6 dot-elements per minute, or 11.56 per second, corresponding to a frequency of 5.78 dots and pauses per second ($n = 5.78$), for which $\omega = 6.283 \times 5.78 = 33.62$ radians

per second. We may suppose the cable to be connected in the following different ways:

- (1) To ground directly at *B*, the receiving end.
- (2) To ground through a siphon-recorder of 500 ohms and 0.25 henry at *B*, as in Fig. 3.

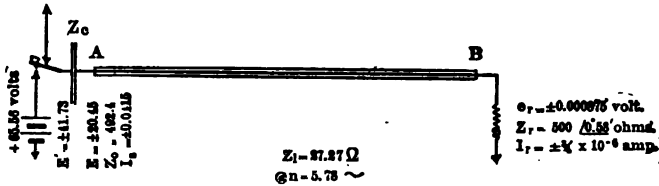

FIG. 5.—CONDENSER OF 50 MICROFARADS AT SENDING END.

- (3) The said siphon-recorder and a 50-microfarad condenser in series at *B*, as in Fig. 4.
- (4) The siphon-recorder at *B*, and the condenser at *A*, as in Fig. 5.
- (5) Condensers at each end, and the cable duplexed, as in Fig. 6.

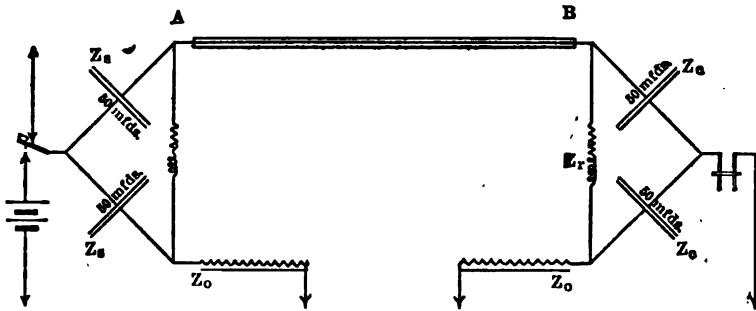

FIG. 6.—CONDENSER OF 50 MICROFARADS AT EACH END AND CABLE DUPLEXED.

- (1) CABLE TO GROUND AT THE RECEIVING END THROUGH RECEIVER OF NEGLIGIBLE RESISTANCE.

The receiving-end-impedance, by formula (12) is

$$Z_1 = z_0 \sinh La$$

$$z_0 = \sqrt{\frac{r}{jcw}} = \sqrt{\frac{3.041 \times 10^6}{j0.8729 \times 33.62}} = \sqrt{\frac{0.2425 \times 10^6}{j}} = 492.4 \sqrt{45^\circ} \text{ ohms.}$$

$$\alpha = \sqrt{r \times jcw} = \sqrt{j 3.041 \times 0.8729 \times 33.62 \times 10^{-6}} = \sqrt{j 38.12 \times 10^{-6}} = 0.006174 \sqrt{45^\circ}$$

$$La = 2518 \times 0.006174 \sqrt{45^\circ} = 15.55 \sqrt{45^\circ}$$

It is to be observed that $La = \sqrt{\tau\omega}$; (14)

where τ is the time-constant (CR) of the cable in seconds.

$$\sinh(La) = 29,849 / 630^\circ$$

$$\therefore Z_1 = 492.4 \sqrt{45^\circ} \times 29,849 / 630^\circ = 14,697,000 / 585^\circ \text{ ohms.}$$

If the minimum amplitude (from zero) of sinusoidal current discernible at B is say $3/4$ microampere (corresponding to a double-amplitude of $1\ 1/2$ microamperes), then the sinusoidal e.m.f. at A of $5.78 \sim$ which will produce that current at B is

$3/4 \times 10^{-6} \times 14.697 \times 10^6 / 585^\circ$ max. cyclic volts /
or $E_s = I_r \cdot Z_1 = 11.02 \pm$. The rectangular e.m.f. of the same frequency which develops this sinusoid is

$$E_s = \frac{\pi}{4} \times 11.02 = 8.657 \text{ volts } \pm$$

If then 8.657 volts be steadily applied to the cable at A , and a rectangular alternating e.m.f. of $8.657 \pm$ volts superposed, dot-signals of ± 17.314 volts with equal intermediate pauses to ground

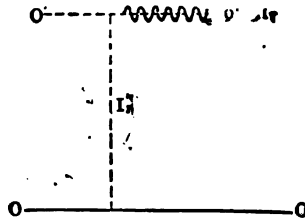

FIG. 7.— STEADY CURRENT I_r' WITH SINUSOIDAL RIPPLE SUPERPOSED, HAVING THE DOUBLE AMPLITUDE $2I_r$. RECEIVED CURRENT WHEN NO CONDENSERS ARE IN CIRCUIT, AND DOT-SIGNALS ARE SENT STEADILY AT A .

are produced. The steady voltage will give rise to a steady current at B of $I_r' = \frac{8.657}{7657} = 0.00113$ amperes, or 1130 microamperes, represented in Fig. 7, by the dotted line $o'o'$, at a distance I_r' from the zero line oo ; while the sinusoidal current will superpose the wavy line about $o'o'$ as zero, with double amplitude $2I_r$.

In order to show that the upper harmonics of sinusoidal current have no appreciable influence at B , consider the receiving-end-impedance to the current of triple frequency ($n = 17.34 \sim$; $\omega = 100.84$).

$$\text{Here } z_0 = 284.3 \sqrt{45^\circ} \text{ ohms.}$$

$$La = 26.93 / 45^\circ$$

$$\sinh La = 1.878 \times 10^{10} / 1890^\circ$$

$$Z_1 = z_0 \sinh La = 284.3 \sqrt{45^\circ} \times 1.878 \times 10^{10} / 1890^\circ$$

$$= 5.339 \times 10^{12} / 1845^\circ$$

The same rectangular e.m.f. of + 17.134 volts in dot-and-pause cycles at *A*, will produce a sinusoid of ± 3.673 volts maximum; cyclic amplitude at *A*, the current from which at *B* is

$$\pm \frac{3.673}{5.339 \times 10^{12} / 1845^\circ} = 0.688 \times 10^{-12} \sqrt{1845^\circ} \text{ amperes; or less than}$$

one millionth of one microampere, lagging 1845°.

At *A*, the current entering the cable will be

+ 1.13 milliamperes of steady current

± 22.38 milliamperes max. cyclic amplitude of sinusoid of frequency 5.78 ~

± 12.92 milliamperes max. cyclic amplitude of sinusoid of frequency 17.34 ~

± 10.63 milliamperes max. cyclic amplitude of sinusoid of frequency 28.90 ~

± 8.46 milliamperes max. cyclic amplitude of sinusoid of frequency 40.46 ~

et cetera, the successive harmonic currents increasing in frequency as the odd numbers, and having amplitudes inversely as the square roots of those numbers.

At the sending end, when the frequency of dot-signals approaches the maximum working limit, the steady current is a relatively petty current by comparison with the first members of the series of harmonic currents. At the receiving end, however, the same steady current is enormous relatively to the strongest sinusoid, and only the fundamental sinusoid appears, as a faint ripple on the edge of the current which it swamped at starting. Since in changing from dot-signals to dash-signals, the steady current of 1130 microamperes at *B* will change from + to -, while the ripples will retain their double amplitude of 1.5 microampere, the unsuitability of signaling without condensers over a long cable is manifest. Whereas series of dots or of dashes will only have a double amplitude of 1 1/2 microamperes, the zero of such ripples will shift through 2260 microamperes. The insertion of a condenser into the cable circuit stops the steady current and gives passage only to the sinusoidal ripples. The zero line of these ripples will be the same, whether dots or dashes are being sent in succession.

(2) SIPHON RECORDER INSERTED AT B. SAME FREQUENCY.

(FIG. 3.)

In this case the receiving-end-impedance $Z_1 = (z_0 + z_r) \sinh La$
 $z_r = (\text{resistance} + j \text{ reactance})$ of the siphon recorder coil = $500 + j 33.62 \times 0.25 = 500 + j 8.4 = 500.1 / 0^\circ.58'$ ohms.
 $z_0 = 492.4 \sqrt{45^\circ} = 348.2 - j 348.2$ ohms.
 $z_0 + z_r = 848.2 - j 339.8 = 913.7 \sqrt{21^\circ.50'}$ ohms.
 $\sinh La = 29.849 / 630^\circ$
 $Z_1 = 913.7 \times 29.849 / 608^\circ.10' = 27,270,000 / 608^\circ.10'$ ohms.
 $= 27.27 / 608^\circ.10'$ megohms.

The sinusoidal e.m.f. at A required to produce $\pm 3/4$ microampere max.: cyclic amplitude at B will be, at $n = 5.78 \sim$.

$$E_s = 27.27 \times 3/4 = 20.45 \pm \text{volts.}$$

or $E_s = \frac{\pi}{4} \times 20.45 = 16.07 \pm$ volts rectangular alternating e.m.f.
 $= + 32.14$ volts in dot-and-pause sending.

The required sinusoidal current would be superposed upon a steady current of $I_s' = I_r' = \frac{+ 16.07}{7667 + 500} = + 0.00197$ ampere; or $+ 1970$ microamperes.

No change in the impedance at B exercises any appreciable influence upon the sending-end-impedance z_0 . This remains at $492.4 \sqrt{45^\circ}$ ohms; whether the cable at B be freed or grounded or put to ground through impedances.

It is clear that the insertion of the siphon-recorder at B has required the rectangular e.m.f. E_s at A to be increased from $+ 17.314$ to $+ 32.14$ volts in dot-impulses, or nearly doubled, the receiving-end-impedance having been increased by the recorder-coil from 14.7 to 27.27 megohms. Conversely, if the $+ 17.314$ volts had remained unaltered, the insertion of the siphon-recorder would have reduced the amplitude of the sinusoidal ripple at B nearly 50 per cent. If this had originally been just sufficient to discern, it would have been rendered undiscernible by the change, so that the receiving-end-impedance would have had to be reduced, by reducing the frequency, and $\sinh La$.

Best Resistance of Siphon-Recorder or Other Receiving Instrument.

It is evident from the preceding section that the influence of the receiving instrument resistance is very marked upon the magnitude of the received sinusoidal ripple superposed on the steady current in dot-signaling. If the receiving coil has fixed dimensions, a

winding of very fine wire will make a coil of numerous turns and, therefore, great sensibility, but with very high resistance. On the contrary, if the coil is formed of coarse wire, the resistance will be small, but the sensibility will be low. Evidently it is advantageous to reduce the size of the insulated wire until increase of resistance more than offsets the increase of sensibility. If throughout the range of working sizes of wire, the ratio of bare to covered wire is the same, so that the same total weights of copper and of insulating material will enter the coil with each size; then halving the diameter of the wire will quadruple the number of turns, and the sensibility to a given current, but will increase the resistance sixteen-fold. Following this reasoning, the sensibility of a given size of coil, mounted in a given geometrical construction, in a given magnetic field, varies as the square root of the coil's resistance. Consequently the maximum cyclic amplitude of a signal, in centimeters, will be $bI_r \sqrt{R_r}$ where b is a constant of the instrument, that may be called the sensibility-constant, and R_r is the resistance of the receiver. Since we have by formulas (11) and (13)

$$I_r = \frac{\frac{4}{\pi} \mathfrak{E}}{(z_0 + z_r) \sinh La} \quad \text{amperes (15)}$$

the maximum cyclic magnitude \pm of the received signals = $\frac{4b}{\pi} \sqrt{R} \times \mathfrak{E}$ centimeters, where \mathfrak{E} is the magnitude of the rectangular \pm alternating e.m.f. If we denote by $\mathfrak{E} = 2 \mathfrak{E}$ the magnitude of the \pm voltage applied in dot-and-pause signals, we obtain:

max: cyclic magnitude of sinusoidal received dot-signals

$$= \frac{\frac{2b}{\pi} \sqrt{R} \mathfrak{E}}{(z_0 + z_r) \sinh La} \quad \text{centimeters (16)}$$

or the double-amplitude of the received signals

$$= \frac{\frac{4b}{\pi} \sqrt{R} \mathfrak{E}}{(z_0 + z_r) \sinh La} \quad \text{centimeters (17)}$$

It is easily shown that this expression is a maximum when the resistance R_r of the receiver is equal in magnitude to the impedance $(z_0 + z_r)$ when $R_r = 0$; i. e., for the case of no resistance in the receiver. That is for maximum signals

$$R_r = (z_0 + z_r)_{R_r=0} \quad \text{ohms (18).}$$

In the case considered, the impedance z_r of the receiver is that of the siphon-recorder coil, there being no receiving condenser. If then we ignore the reactance of the recorder coil, $z_r = 0$ when $R_r = 0$, and $z_o + z_r = z_o$. Consequently $R_r = z_o$ ohms. The resistance of the recorder-coil for largest signals at the frequency selected should, therefore, be equal to the sending-end-impedance, when no condensers are used at B. In the case considered $z_o = 492.4 \sqrt{45^\circ}$ ohms, and the resistance of the recorder-coil should be 492.4, or say about 500 ohms. Since z_o depends upon the ratio

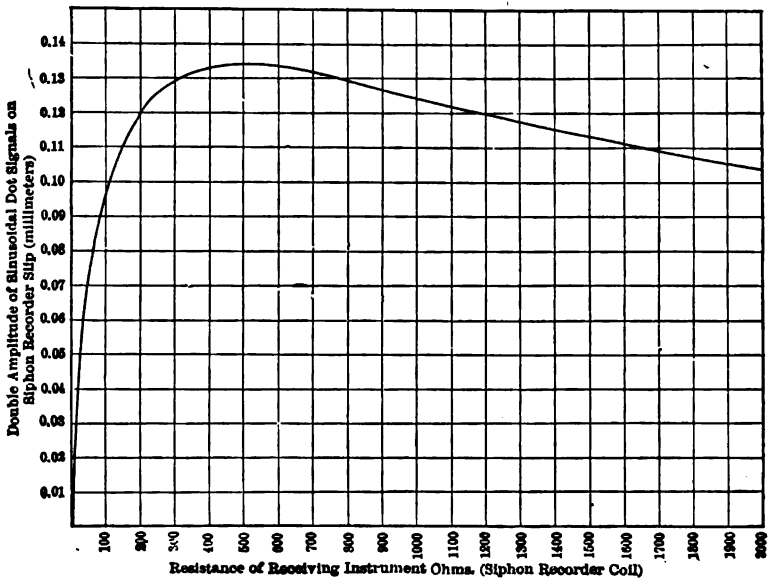

FIG. 8.— DOUBLE AMPLITUDE OF RECEIVED SIGNALS FOR CABLE CONSIDERED WITH +32.14 VOLTS, APPLIED TO SENDING END IN DOTS AND PAUSES, AT FREQUENCY OF 5.78 \sim , WITH VARYING RESISTANCES OF SIPHON RECORDER COIL AT RECEIVING END, THE SENSIBILITY-CONSTANT OF THE INSTRUMENT BEING 400.

r/o and varies inversely as the frequency, the greater the ratio r/o and the lower the frequency of signaling, the greater should be the resistance of the receiver. Moreover, the resistance of the receiver does not depend upon the length of the cable, except in so far as the length determines the signaling-frequency.

For the case considered, and the sensibility-constant $b = 400$, the accompanying curve-sheet, Fig. 8, gives the magnitude of signals at B in millimeters of ripple double-amplitude for varying

resistances in the recorder-coil, as determined by the size of wire in its winding, the frequency remaining constant at $n = 5.78 \sim$ and the sending battery at $E_s = +32.14$ volts, as derived from formula (17). It will be observed that while the maximum double-amplitude of nearly $1/7$ mm is obtained when the wire in the recorder-coil gives 492.4 ohms resistance, yet practically the same amplitude would be secured whether the resistance were 300 ohms, 800 ohms or any value between them.

Siphon Recorder at B. Frequency Variable.

If the maximum cyclic strength of the received current required to give readable dot-signals is changed from $\pm 3/4$ microampere to say $+1$ microampere, as by some reduction in the sensibility, and sensibility-constant, of the instrument, the frequency of dot-signaling must be reduced, if the sending battery is already at its maximum available voltage, in order to reduce the receiving-end-impedance. Thus, in the preceding case, ± 1 microampere at B with $+32.14$ volts at the sending battery and negligible drop in the battery ($E_s = +32.14$, $E_r = \pm 16.07$, $E_g = \pm 20.45$) will require a receiving-end-impedance of 20.45 megohms, instead of 27 megohms, a reduction of 25 per cent. That is, the quantity $(z_o + z_r) \sinh La$ must be reduced 25 per cent. Nearly all of the reduction will have to be made in the hyperbolic factor, since the sending-end-impedance varies much more slowly with the frequency. This means that $\sinh La$ must be reduced from 29,849 to about 22,380. The corresponding value of La is 15.145, and $a = \frac{15.145}{2518} = 0.006015/45^\circ$. From this ω is found to be $n = 5.077$, instead of 5.78 cycles per second; so that the speed of dot-signaling has to be reduced 12.2 per cent, in order to secure the greater sinusoidal current strength desired. If the sending-end-impedance z_o be recomputed for this frequency, by formula (7), it will be found to be $505.6 \sqrt{45^\circ}$ ohms, an increase of 2.7 per cent over the previous value. The receiving-end-impedance at $5.077 \sim$ would be

$$\begin{aligned} Z_1 &= (505.6 \sqrt{45^\circ} + 500) \frac{22,380}{613^\circ.20'} \\ &= 929 \sqrt{22^\circ.38'} \times \frac{22,380}{613^\circ.20'} \\ &= 20.79 \text{ megohms} / 590^\circ.42' \end{aligned}$$

The sinusoidal current of $+1$ microampere would lag $590^\circ.42'$ or about $1\frac{1}{2}$ cycles behind the impressed e.m.f.

(3) SIPHON RECORDER AND 50-MICROFARAD CONDENSER AT RECEIVING END.

The effect of inserting a condenser at the receiving end B in Fig. 4 has no effect at the sending end near the limiting frequency of transmission, except to stop the steady current $I_s = I_r$ of dot-signaling. The effect at the receiving end is to stop the wandering of the siphon due to the current I_r , when changing from dots to dashes, and also to increase the impedance of the receiving apparatus z_r .

Considering the circuit of Fig. 4, the impedance of a 50-microfarad condenser to sinusoidal currents of frequency $5.78 \sim \omega = 33.62$, is $\frac{1}{j50 \times 10^{-6} \times 33.62} = \frac{1}{j1681 \times 10^{-6}} = 594.9 \sqrt{90^\circ}$ ohms. Consequently $z_r = (500 + j8.405) - j594.9 = 500 - j586.5 = 770.7 \sqrt{49^\circ.33'}$ ohms.

And the receiving-end-impedance by formula (13) is

$$\begin{aligned} Z_1 &= (492.4 \sqrt{45^\circ} + 770.7 \sqrt{49^\circ.33'}) \times 29,849 / 630^\circ \\ &= 1339 \sqrt{47^\circ.47'} \times 29,849 / 630^\circ = 39,970,000 / 582^\circ.13' \text{ ohms,} \\ &= 39.97 / 582^\circ.13' \text{ megohms.} \end{aligned}$$

If the maximum cyclic amplitude of received current at B is $\pm 3/4$ microampere, the maximum cyclic amplitude of sinusoidal e.m.f. at A will be $E_s = 3/4 \times 39.97 = 29.97$ volts, from which the cyclic value of the corresponding rectangular e.m.f. is

$$E = \frac{\pi}{4} \times 29.97 = \pm 23.54 \text{ volts.}$$

Or in dot-signaling to battery and ground alternately, the battery e.m.f. is $E = +47.08$ volts.

If dot-signals are sent at A with 47.08 volts of battery, having no appreciable drop by internal resistance, at the rate of 5.78 dots

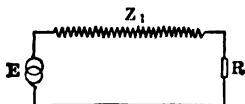

FIG. 9.—EQUIVALENT CABLE-CIRCUIT AT LIMIT OF TRANSMISSION CONSIDERED FROM RECEIVING END.

and pauses per second, or at the rate of 19 five-letter words per minute, the cable and receiving apparatus will behave like a resistance box of 40 megohms (Fig. 9) on short-circuit with an alternator of ± 29.97 volts, permitting an alternating current of $\pm 3/4$ micro-

ampere to flow through the recorder R , at the frequency for which Z_1 is developed. At the sending end the conditions are different. Not only is the fundamental sinusoid more than $\sinh La$ times stronger at A than at B , but there are also a number of upper harmonics of very appreciable strength. These upper harmonics absorb power uselessly from the battery at A , but otherwise they are quite independent of the signaling, neither aiding nor obstructing the working sinusoidal current of fundamental frequency.

Judging from these results it would seem that the limiting speed of signaling on a cable of any assigned length and electrical constants may be that which makes the receiving-end-impedance about 40 megohms.

Best Receiving-Coil Resistance with Condenser at Receiving End.

Formula (18) shows that the best size of wire for the winding of the receiving instrument is greater when a receiving-end condenser is used, because the impedance $(z_0 + z_r)_{R_r=0}$ is increased by the impedance of the condenser. In this case $(z_0 + z_r)_{R_r=0}$ becomes $(492.4 \sqrt{45^\circ} + 586 \sqrt{90^\circ}) = 997.4$ ohms. Consequently, the insertion of a 50-microfarad condenser at B makes a finer winding (1000 ohms) desirable for the recorder-coil, provided that the same total weight of copper enters the coil; or that the smaller wire is not relatively more thickly coated with insulation. The greater the capacity of the receiving condenser, the less its impedance, and the lesser the change of resistance theoretically required in the recorder-coil. The receiving condenser always adds to the receiving-end-impedance, although its presence is required to stop the steady current of dot-signaling, or its equivalent the large range of shifting zero in the mixed signals of cable code. In this case the 50-microfarad condenser brings the receiving-end-impedance from 27.27 to 39.97 megohms.

(4) CONDENSER INSERTED AT THE SENDING END.

If the condenser is inserted at the sending end as in Fig. 5 the case reverts to (2) above considered, except that the steady current I_r is cut off and that the impressed e.m.f. on the cable at A is reduced by the drop in the condenser. For the conditions above considered the receiving-end-impedance is 27.27 megohms, and $3/4$ microampere maximum cyclic current at B , with $n = 5.78 \sim$, will call for an impressed sinusoidal e.m.f. at A of $E_s = \pm 20.45$ volts

maximum cyclic amplitude. The sending-end-impedance is $z_0 = 492.4 \sqrt{45^\circ}$ ohms, and the impedance of the condenser to the frequency of 5.78 \sim is $z_c = -j 594.9 = 594.9 \sqrt{90^\circ}$.

Consequently, the maximum cyclic e.m.f. behind the condenser will be

$$\begin{aligned} 20.45 \left(\frac{z_c + z_0}{z_0} \right) &= 20.45 \frac{(594.9 \sqrt{90^\circ} + 492.4 \sqrt{45^\circ})}{492.4 \sqrt{45^\circ}} \\ &= 20.45 \left(\frac{1005 \sqrt{69^\circ.44'}}{492.4 \sqrt{45^\circ}} \right) = 20.45 \times 2.041 \sqrt{24^\circ.44'} \\ &= 41.73 \sqrt{24^\circ.44'} \text{ volts } \pm. \end{aligned}$$

The corresponding rectangular e.m.f. is $\mathfrak{E} = +32.78$ volts, or, in dot-space-dot-signaling $\mathfrak{E} = +65.56$ volts.

The effect of inserting the condenser at the sending end instead of at the receiving end of the cable is to leave the receiving-end-impedance the same as with no condensers, but to reduce the impressed e.m.f. from $+41.73$ maximum sinusoidal to $+20.45$.

For the same condenser-capacity, and amplitude of received signals, the sending battery is $+47.08$ volts when the condenser is inserted at B , and $+65.56$ volts when the condenser is inserted at A . The battery would thus be 39.2 per cent greater in the latter case. This means that if the battery were limited to 47.08 volts, the speed of transmission would be lowered by changing the condenser from the receiving end B to the sending end A . This proposition seems to be quite general. If, however, the maximum impressed voltage on the end of the cable at A , and not the battery voltage is to be the criterion, then the maximum cyclic amplitude E is $+29.97$ volts when the condenser is inserted at B , and E is $+20.45$ volts when the condenser is inserted at A . So that if we consider only the maximum electric stress on the cable, that stress is less in the case considered by 31.8 per cent when the condenser is used at the sending end, while the same magnitude and frequency of received dots are produced, the receiving-end-impedance being 31.8 per cent less in the latter case for the same 500-ohm recorder-coil. The maximum speed of dot-signaling is, therefore, greater for a given impressed e.m.f. at A , when the condenser is at the sending end.

The best resistance for the receiving instrument (assumed reactanceless), when the condenser is at A , is equal to the sending-end-impedance z_0 . In the case considered, it would be nearly 500 ohms.

With the condenser at *A*, the cyclic maximum current received at

$$B \text{ is } I_r = \frac{\frac{2}{\pi} \frac{E}{L}}{z_s + z_o} \times \frac{z_o}{(z_o + z_r) \sinh La} \pm \text{amperes } \angle \quad (19)$$

This current increases as z_s is reduced; i. e., as the condenser at *A* is increased in capacity, the speed of signaling being kept constant.

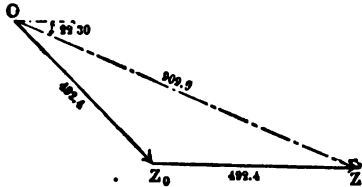

FIG. 10.— IMPEDANCE ($z_o + z_r$) OF CABLE FOR THE FREQUENCY 5.78 ~ AND A RECORDER-COIL OF NO REACTANCE AND BEST RESISTANCE.

The formula (19) shows that while the impedance factor $\sinh La$ is a definite constant of any laid cable at given transmission speed, it multiplies into the impedance ($z_o + z_r$) ohms which is the sum of the impedances of the sending-end and of the receiving apparatus respectively. Fig. 10 shows the vector Oz_o drawn to represent the impedance $z_o = 492.4 \sqrt{45^\circ} = 348.2 - j 348.2$ ohms. The vector $z_o Z$ represents the best resistance of the receiving instrument, as-

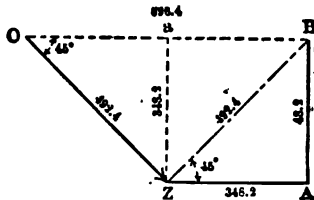

FIG. 11.— IMPEDANCE ($z_o + z_r$) OF CABLE FOR THE FREQUENCY 5.78 ~ AND A RECORDER-COIL OF $j 348.2$ OHMS REACTANCE AND BEST RESISTANCE.

sumed reactanceless, there being no receiving-end condenser. This is also 492.4 ohms. The vector $OZ = 909.8 \sqrt{22^\circ.30'}$ represents the sum ($z_o + z_r$). If, however, the receiving instrument could be given a reactance of $j 348.2$ ohms, without additional resistance, the best resistance of the coil would, by formula (18), become $(492.4 \sqrt{45^\circ} + j 348.2 / 90^\circ) = 348.2$ ohms. The impedance of the coil would then be $348.2 + j 348.2 = 492.4 \sqrt{45^\circ}$, with a reactance equal to resistance, or reactance factor of unity. As shown in Fig. 11,

the impedance ($z_0 + z_r$) then becomes $(492.4 \sqrt{45^\circ} + 492.4 / 45^\circ) = OB = 696.4 / 0^\circ$ ohms. This would result in diminishing the receiving-end impedance from

$$\begin{aligned} & 909.8 \frac{22^\circ 30'}{0^\circ} \times 29,849 / 6308 = 27.156 \text{ megohms } / 607^\circ .80' \\ & \text{to } 696.4 / 0^\circ \times 29,849 / 630^\circ = 20.78 \text{ megohms } / 631^\circ .0 \end{aligned}$$

This would be a reduction of 23 1/2 per cent and would increase the amplitude of the received signals 23 1/2 per cent at *B* for the same battery and frequency at *A*; or it would enable the frequency and speed of transmission to be increased about 10 per cent for the same amplitude of received signals. The ideal receiving instrument, therefore, instead of having its *resistance* equal to the sending-end-impedance, and no reactance, has an *impedance* equal to the sending-end-impedance and with as much reactance as resistance, at the frequency of maximum transmission; or, its impedance is equal to the sending-end-impedance, with the opposite angle ($+ 45^\circ$ instead of $- 45^\circ$).

The reactance required in z_r being in this case 348.2 ohms, and the angular velocity only 33.62 radians per second, the inductance needed in the receiver is $\frac{348.2}{33.62} = 10.36$ henrys, many times greater than the inductance of the ordinary recorder-coil. In a coil of air magnetic circuit, such an inductance would probably require a resistance of at least 500 ohms, outside of the recorder, and would for maximum inductance. This extra 500 ohms resistance would more than destroy the benefit of the added inductance. Such a choking coil in circuit with the recorder-coil would reduce, instead of increase, the speed of transmission. On the other hand, the inductance of the recorder-coil is beneficial so far as it goes, and it is possible that a choking coil on a closed magnetic circuit of soft steel, capable of magnetically responding to the feeble received currents, might add benefit from inductance more than would be lost by its extra resistance in the receiving circuit.

The next best expedient to a reactance coil of large time constant and low resistance, in series with the recorder, would be a reactance coil of large time constant and greater resistance, in shunt to the recorder. From its electric constants, the value of such a coil could be readily computed as above.

The sending-end-impedance z_0 of a cable is not susceptible of modification after the cable has been laid. Impedances inserted at the sending end only modify the magnitude of the working e.m.f.

necessary to impress a given sinusoidal maximum impressed e.m.f. on the cable.

According, therefore, to the alternating-current theory of cable signaling, the highest speed is attainable from a given laid cable by placing a large condenser at the sending end, impressing the assigned maximum e.m.f. on the sending end, and making the impedance of the receiving instrument (assumed of maximum sensitiveness in construction) equal to the sending-end-impedance, but with the opposite angle.

Condenser at Each End of the Cable. Duplex System.

If the duplex connections are as shown in Fig. 6, the system is electrically equivalent to the simplex system shown in Fig. 12.

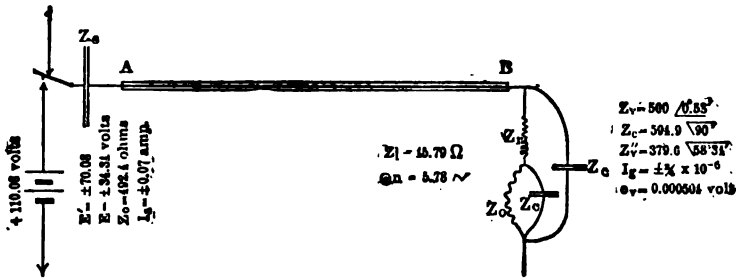

FIG. 12.—EQUIVALENT SIMPLEX CONNECTIONS OF DUPLEX SYSTEM SHOWN IN FIG. 6.

Here z_0 at B is the sending-end-impedance of the artificial line. If this artificial line is a level imitation of the actual cable, then $z_0 = 492.4 \sqrt{45^{\circ}}$ the same as the actual cable offers at A. Similarly $z_0 = 594.9 \sqrt{90^{\circ}} = z_c$. The impedance of the receiving instrument at

$$\begin{aligned}
 B \text{ is increased by } z_0 \text{ and } z_c \text{ to } z'_r &= z_r + \frac{z_0 z_c}{z_0 + z_c} \\
 &= 500 / 0^{\circ} 58' + \frac{492.4 \sqrt{45^{\circ}} \times 594.9 \sqrt{90^{\circ}}}{492.4 \sqrt{45^{\circ}} + 594.9 \sqrt{90^{\circ}}} \quad \text{ohms.} \\
 &= 672.7 \sqrt{22^{\circ} 24'} \quad \text{ohms.}
 \end{aligned}$$

The receiving connections are, therefore, equivalent to an instrument impedance z'_r of $672.7 \sqrt{22^{\circ} 24'}$ ohms, shunted by a condenser of impedance z_0 of $594.9 / 90^{\circ}$. This in turn will be found equal to a single receiving instrument impedance of

$$z''_r = \frac{z'_r z_0}{z'_r + z_0} = \frac{672.7 \sqrt{22^{\circ} 24'} \times 594.9 \sqrt{90^{\circ}}}{672.7 \sqrt{22^{\circ} 24'} + 594.9 \sqrt{90^{\circ}}} = 379.6 \sqrt{58^{\circ} 34'} \text{ ohms.}$$

The recorder is, however, shunted with a multiplying power of

$$N = \frac{z'_r + z_c}{z_c} = \frac{672.7 \sqrt{22^\circ.24'} + 594.9 \sqrt{90^\circ}}{594.9 \sqrt{90^\circ}} = 1.772 \sqrt{36.10'}$$

The receiving-end-impedance of the system is, therefore,

$$\begin{aligned} Z_1 &= N(z_o + z'_r) \sinh La \\ &= 1.772 \sqrt{36^\circ.10'} (492.4 \sqrt{45^\circ} + 379.6 \sqrt{58^\circ.34'}) \sqrt{29,849 \sqrt{630^\circ}} \\ &= 45.79 \sqrt{615^\circ.17'} \text{ megohms.} \end{aligned}$$

The impressed maximum sinusoidal e.m.f. at the sending end for $\pm 3/4$ microampere maximum sinusoidal current in the recorder, is $E = \pm \frac{3}{4} \times 45.79 \sqrt{615^\circ.17'} = \pm 34.34 \sqrt{615^\circ.17'}$ volts. At the key, behind the condenser at *A*, this requires a maximum sinusoidal e.m.f.

$$E' = \pm 34.34 \sqrt{615^\circ.17'} \times 2.041 \sqrt{24^\circ.44'} = \pm 70.08 \sqrt{590^\circ.33'} \text{ volts}$$

and in rectangular e.m.f. $E = \pm \frac{\pi}{4} \times 70.08 = \pm 55.04$ volts.

Or for dot-and-ground signals $E = + 110.08$ volts.

If the e.m.f. of the battery is limited to say 65.56 volts, as in Fig. 5, the speed of signaling in duplex connections must be reduced sufficiently to reduce the receiving-end-impedance about 40 per cent. The figures seem to show the maximum speed of transmission that can be reached with the best simplex connections is always greater than that attainable in the same direction, with the corresponding duplex connections.

CONCLUSIONS.

According to the alternating-current theory of cable-signaling, as above outlined, the receiving-end-impedance is the true criterion of any signaling circuit for given limits of impressed e.m.f. at the sending end, and sensibility of apparatus at the receiving end. The proposition applies, however, not merely to long submarine cables, but also to long-distance telegraph and telephone aerial circuits. The *CR* time-constant of a cable (farad-ohms = seconds) is a first approximation to this receiving-end-impedance, because for an assigned value of the impedance multiplier $\sinh La$, the frequency limit is inversely proportional to the time-constant.*

* Formula (1) may be interpreted by (14) as equivalent to the equation $La = 15.16$ or to the equation $\sinh La = 22,610$. This would indicate a signaling speed about 10 per cent less than that derived from the data assumed in this paper, for which $\sinh La = 29,849$, or $n = \frac{11.38}{-}$ letters per sec

Whereas, however, the time-constant of a circuit ceases to be a criterion of long-distance transmission when the circuit possesses considerable inductance, or leakance, or both, the receiving-end-impedance of the same symbolic expression (10) but very different magnitude, is still the true criterion. Moreover, even in long cable-circuits, the time-constant CR is only a first approximation to the speed criterion, because of the influence of the $(z_o + z_r)$ impedance in the phenomena of signaling, which impedance does not enter into the time-constant.

The real speed criterion, therefore, of any long signaling circuit is $Z_1 = z_o \sinh La + z_r \cosh La$ ohms.

Experimental Data Required for the Further Development of the Theory.

In order to develop the application of the above outlined theory experimental observations should be secured upon the following matters:

(1) To determine experimentally the limits of receiving-end-impedance in dot-signaling over long cables, under measured frequency, impressed e.m.f. terminal condenser, and sensibility of receiving apparatus. It seems important to determine how far this limiting value of receiving-end-impedance departs, in practice, from the estimate above given of 40 megohms.

(2) To ascertain what is the relative frequency of mixed signaling in industrial practice to dot signaling as determined by alternating-current-theory. The practical frequency of mixed signaling may be either greater than, or less than that of dot-signaling, but perhaps bears a definite empirical ratio thereto.

(3) To ascertain the effect of curb-signaling upon this ratio.

(4) To ascertain the practical value of reactance at the receiving end, and how far this value agrees with that assigned by the alternating-current theory.

Some of these observations are probably capable of best being made over artificial cables.

A bibliography of reference is appended. It does not pretend to be complete.

A table of hyperbolic vector functions having the angle 45 deg., is also appended together with some of the important formulæ applying to such functions.

BIBLIOGRAPHY.

- (1) Sir William Thomson, F.R.S. (Lord Kelvin):
 "On The Theory Of The Electric Telegraph." *Proc. Roy. Soc.*, May, 1885; *vide* "Reprinted Papers," Vol. 2, p. 61.
 "Telegraph To America." *The Athenæum*, Oct. 4, 1856;
vide "Reprinted Papers," Vol. 2, pp. 92-102.
 "On Practical Methods For Rapid Signaling By The Electric Telegraph." *Proc. Roy. Soc.*, December, 1856;
Philosophical Magazine, July, 1857; *vide* "Reprinted Papers." Vol. 2, pp. 103-111.
- (2) Fleeming Jenkin, F.R.S.:
 "Experimental Researches On The Transmission Of Electric Signals Through Submarine Cables." *Proc. Roy. Soc.*, June, 1862, Vol. 152, pp. 987-1017.
 "Electricity And Magnetism." *Philosophical Magazine*, June, 1865 (7th ed.), 1883, pp. 329-337.
- (3) Charles Hockin, M.A.:
 "On The Magnitude Of The Signals Received Through A Submarine Cable With Various Connections At Each End, And The Best Resistance For The Recording Instrument." *Journal Soc. of Tel. Engrs.*, Vol. 5, 1876, pp. 432-459.
- (4) A. Gray, M.A., F.R.S.E.:
 "The Theory And Practice Of Absolute Measurements In Electricity and Magnetism." London, 1888, Vol. 1, pp. 166-178.
- (5) Oliver Heaviside:
 "On Telegraphic Signaling With Condensers." *Philosophical Magazine*, June, 1874, Vol. 47, p. 426; *vide* "Electrical Papers," London, 1892, Vol. 1, pp. 47-53.
 "On The Theory Of Faults In Cables." *Philosophical Magazine*, July and August, 1879, Vol. 8; *vide* "Electrical Papers," Vol. 1, pp. 71-95.
 "Electromagnetic Theory." London, 1893, Vol. 1, pp. 417-447.
- (6) E. Raymond Barker:
 "Speed Standards And Circuit Efficiency." pp. 370-372; Munro and Jamieson's "Pocket Book Of Electrical Tables," 1901.
- (7) G. K. Winter, F.R.A.S.:
 "On The Use Of Electromagnetic Instead Of Electro-



static Induction In Cable Signaling." B. A. Meeting, Brighton, 1872. See pp. 291-293, *Journal*, Soc. of Tel. Engrs., Vol. 1, 1872.

"On The Use Of Electromagnetic Induction In Cable Signaling." *Journal* Soc. Tel. Engrs., pp. 103-106, Vol. 3, 1874.

(8) James Graves:

"On Curbed Signals For Long Cables." *Journal* Soc. of Tel. Engrs., 1879, pp. 92-98, Vol. 8.

(9) Willoughby Smith:

"The Working Of Long Submarine Cables." *Journal* of the Soc. of Tel. Engrs., 1879, pp. 63-126, Vol. 8.

(10) R. S. Culley:

"A Handbook Of Practical Telegraphy." London, 1885, pp. 368-376.

(11) A. E. Kennelly:

"A Contribution To The Theory Of Telephony." *Electrical World*, Vol. 23, No. 27, p. 208, February, 1894.

"On Electric Conducting Lines Of Uniform Conductor And Insulation Resistance In the Steady State." *Harvard Engineering Journal*, May, 1903, pp. 135-168.

(12) Edwin J. Houston and A. E. Kennelly:

"Resonance In Alternating-Current Lines." *Trans. Am. Inst. El. Engrs.*, Vol. 12, pp. 133-169, April, 1895.

(13) Albert G. Crehore, Ph.D., and George O. Squier, Ph.D.:

"A Practical Transmitter Using The Sine Wave For Cable Telegraphy; And Measurements With Alternating Currents Upon An Atlantic Cable." *Trans. Am. Inst. El. Engrs.*, Vol. 17, May 18, 1900, pp. 385-443.

"A Practical Telegraphic Transmitter Using Sine-Waves." *Trans. Int. El. Congress at Paris*, 1900, Vol. 2, pp. 276-285.

(14) M. I. Pupin, Ph.D.:

"Wave Transmission Over Non-Uniform Cables And Long Distance Air-Lines." *Trans. Am. Inst. El. Engrs.*, Vol. 17, May 19, 1900, pp. 445-513.

APPENDIX.

TABLE OF HYPERBOLIC FUNCTIONS OF SEMI-IMAGINARY QUANTITIES.

Tables are readily obtainable which supply the hyperbolic functions of a real variable x ; namely, $\sinh x$; $\cosh x$; $\tanh x$; $\operatorname{cosech} x$;

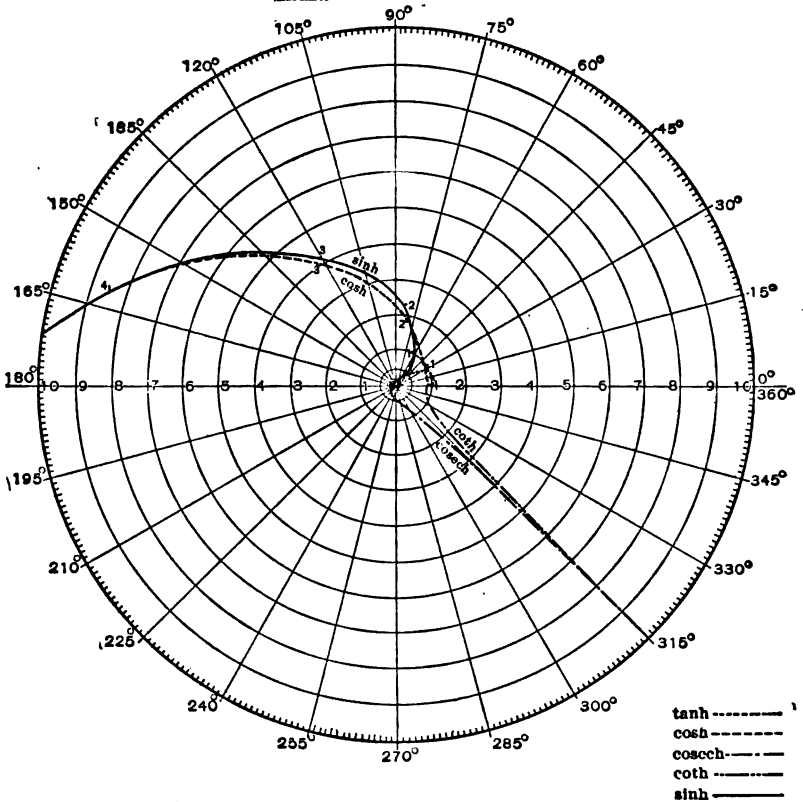

FIG. 13.—LOCI OF \sinh , \cosh , \tanh , \coth AND $\operatorname{cosech} x / 45^\circ$ BETWEEN THE LIMITS OF 0 AND 10 OF THE RESULT.

$\operatorname{sech} x$ and $\operatorname{coth} x$. If x be an imaginary quantity such as jy ; then the preceding quantities become respectively

$$j \sin x; \cos x; j \tan x; -j \operatorname{cosec} x; \sec x \text{ and } -j \cot x.$$

The theory of alternating-current transmission on circuits practically devoid of leakance and inductance brings into prominence hyperbolic functions of quantities of the type $(x+jx)$; or having a real component numerically equal to the imaginary component. Such quantities may be described as semi-imaginary quantities. When written vectorially, semi-imaginary quantities are of the type $z/\underline{45^\circ}$ or $z/\overline{45^\circ}$.

For convenience in the application of the theory, the author has computed the following table of $\sinh(z/\underline{45^\circ})$, $\cosh(z/\underline{45^\circ})$, $\tanh(z/\underline{45^\circ})$, $\operatorname{cosech}(z/\underline{45^\circ})$, $\operatorname{sech}(z/\underline{45^\circ})$, and $\operatorname{coth}(z/\underline{45^\circ})$, for all values of z from 0 to 20.50 inclusive, by steps of 0.1 as far as $z=6$, and by steps of 0.05 thereafter.

As an example of the use of the table, consider the vector $z/\underline{45^\circ}$ where $z=2.50$, corresponding to the quantity $(1.7675+j1.7675)$. The table shows that $\sinh 2.5/\underline{45^\circ}=3.0077/100^\circ.39'$, $\operatorname{cosech} 2.5/\underline{45^\circ}=0.3325/\overline{100^\circ.39'}$, $\cosh 2.5/\underline{45^\circ}=2.8501/101^\circ.56'$, $\operatorname{sech} 2.5/\underline{45^\circ}=0.3509/\overline{101^\circ.56'}$, $\tanh 2.5/\underline{45^\circ}=1.0553/\overline{1^\circ.17'}$, $\operatorname{coth} 2.5/\underline{45^\circ}=0.9476/1^\circ.17'$.

In order to form the hyperbolic functions of $z/\overline{45^\circ}$ from the table it is sufficient to remember that

$$\begin{aligned} \text{if } \sinh z/\underline{45^\circ} &= a/\underline{\theta} ; \sinh z/\overline{45^\circ} = a/\overline{\theta} \\ \text{if } \cosh z/\underline{45^\circ} &= a/\underline{\theta} ; \cosh z/\overline{45^\circ} = a/\overline{\theta} \\ \text{if } \tanh z/\underline{45^\circ} &= a/\underline{\theta} ; \tanh z/\overline{45^\circ} = a/\overline{\theta} \\ \text{if } \operatorname{cosech} z/\underline{45^\circ} &= a/\underline{\theta} ; \operatorname{cosech} z/\overline{45^\circ} = a/\overline{\theta} \\ \text{if } \operatorname{sech} z/\underline{45^\circ} &= a/\underline{\theta} ; \operatorname{sech} z/\overline{45^\circ} = a/\overline{\theta} \\ \text{if } \operatorname{coth} z/\underline{45^\circ} &= a/\underline{\theta} ; \operatorname{coth} z/\overline{45^\circ} = a/\overline{\theta} \end{aligned}$$

In words, the inversion of the argument θ involves inversion of the angle in the result.

The tables show that the hyperbolic sine and cosine approximate logarithmic spirals. Very roughly, the hyperbolic sine and cosine of $1/\underline{45^\circ}$ are unity, and as z increases by unity the sine and cosine double; so that for $z/\underline{45^\circ}=1, 2, 3, 4$, etc.

\sinh and $\cosh z/\underline{45^\circ}=1, 2, 4, 8$, etc.

According to this rough rule the \sinh or \cosh of 21 should be 1,048,576, or a little over 1,000,000. One million is actually reached by $\sinh x/\underline{45^\circ}$ and $\cosh x/\underline{45^\circ}$ at $x=20.51$.

The same table may be used for valuating the circular functions of semi-imaginaries under the following relations:

$$\begin{aligned}\sin z/45^\circ &= j \sinh z \sqrt{45^\circ} \\ \cos z/45^\circ &= \cosh z \sqrt{45^\circ} \\ \tan z/45^\circ &= j \tanh z \sqrt{45^\circ}\end{aligned}$$

The formulas by which the table has been computed are:

$$\begin{aligned}\sinh (a + ja) &= \sqrt{\sinh^2 a + \sin^2 a} / \tan^{-1} (\coth a \tan a) \\ \cosh (a + ja) &= \sqrt{\cosh^2 a - \sin^2 a} / \tan^{-1} (\tanh a \tan a)\end{aligned}$$

For values of z above 6, the formula was changed for the following:

$$\sinh (a + ja) = \cosh (a + ja) = \frac{\frac{a}{\sqrt{2}}}{2} \left/ \frac{a}{\sqrt{2}} \right.$$

RESUME OF USEFUL FORMULÆ IN CONNECTION WITH THE THEORY OF ALTERNATING CURRENTS ON SUBMARINE CABLES.

Using the notation employed in the text of the paper, and if e = the voltage at any point of the cable volts

i = the current at the same point of the cable amperes

Then if the point be distant L_1 miles or kilometers from the sending end of the line, the conditions during alternating-current transmission will be

$$e = E \cosh L_1 a - I z_0 \sinh L_1 a \quad \text{volts}$$

$$i = I \cosh L_1 a - \frac{E}{z_0} \sinh L_1 a \quad \text{amperes.}$$

where E is the impressed e.m.f. and I the entering current strength at the sending end.

If, however, the conditions at the receiving end are known, e being the e.m.f. at the receiving end, and i the current strength; then at any point distant L_2 from that end

$$e = e \cosh L_2 a + i z_0 \sinh L_2 a \quad \text{volts}$$

$$i = i \cosh L_2 a + \frac{e}{z_0} \sinh L_2 a \quad \text{amperes}$$

The sending-end-impedance of a cable is always

$$z_s = z_o \left\{ \frac{\tanh (La) + \frac{z_r}{z_o}}{1 + \frac{z_r}{z_o} \tanh (La)} \right\} \quad \text{ohms}$$

where z_r is the impedance of the receiving apparatus.

In the case of any but short cables this reduces to

$$z = z_o \quad \text{ohms.}$$

The receiving-end-impedance of a cable is

$$Z_1 = z_o \sinh (La) + z_r \cosh (La) \quad \text{ohms}$$

On long cables, where $(La) > 6$, $\sinh (La) = \cosh (La)$

and $Z = (z_o + z_r) \sinh (La)$; and if $z_r = 0$ ohms

$$Z_1 = z_o \sinh (La) \quad \text{ohms.}$$

z	Sinh z		Coth z		Tanh z		Cosech z		Sech z		Coth z	
	0.	° /	1.	° /	0.	° /	c.	° /	1.	° /	c.	° /
0		45.00		45.00		45.00		45.00		0.		45.00
0.1	0.09907	45.05	1.00001	0.17	0.09907	44.48	10.0085	45.05	0.99999	0.17	10.0085	44.48
0.2	0.19966	45.23	1.00018	1.09	0.19966	44.14	5.0011	45.23	0.99982	1.09	5.0011	44.14
0.3	0.29994	45.51	1.0007	2.35	0.29973	43.16	3.3840	45.51	0.99928	2.35	3.3840	43.16
0.4	0.39996	46.51	1.0021	4.35	0.3991	41.56	2.0018	46.51	0.9979	4.35	2.0018	41.56
0.5	0.50026	47.33	1.0051	7.03	0.4977	40.15	1.0950	47.33	0.9949	7.03	1.0950	40.15
0.6	0.60055	48.37	1.0107	10.16	0.5943	38.11	1.0051	48.37	0.9894	10.16	1.0051	38.11
0.7	0.70108	49.40	1.0196	13.53	0.6874	35.47	1.4865	49.40	0.9806	13.53	1.4865	35.47
0.8	0.80163	51.05	1.0326	18.00	0.7756	33.06	1.9475	51.05	0.9675	18.00	1.9475	33.06
0.9	0.90221	52.44	1.0503	23.34	0.8576	30.10	1.1070	52.44	0.9494	23.34	1.1070	30.10
1.0	1.00285	54.33	1.0608	27.30	0.9306	27.03	0.3545	54.33	0.9256	27.30	0.3545	27.03
1.1	1.10369	56.31	1.1187	32.41	0.9989	23.50	0.3018	56.31	0.9063	32.41	0.3018	23.50
1.2	1.20465	58.41	1.1606	38.05	1.0456	20.36	0.2623	58.41	0.8614	38.05	0.2623	20.36
1.3	1.30565	61.03	1.2162	43.35	1.0867	17.37	0.7573	61.03	0.8082	43.35	0.7573	17.37
1.4	1.40677	63.34	1.2832	49.05	1.1141	14.39	0.6935	63.34	0.7703	49.05	0.6935	14.39
1.5	1.50795	66.15	1.3616	54.33	1.1333	11.49	0.6496	66.15	0.7244	54.33	0.6496	11.49
1.6	1.60918	69.07	1.4524	59.55	1.1413	9.13	0.6083	69.07	0.6855	59.55	0.6083	9.13
1.7	1.71047	72.03	1.5556	65.10	1.1493	6.88	0.5685	72.03	0.6489	65.10	0.5685	6.88
1.8	1.81182	75.18	1.6718	70.14	1.1580	5.04	0.5295	75.18	0.6061	70.14	0.5295	5.04
1.9	1.91323	78.36	1.7999	75.10	1.1673	3.36	0.4916	78.36	0.5656	75.10	0.4916	3.36
2.0	2.01472	82.03	1.9413	79.56	1.1191	2.06	0.4603	82.03	0.5151	79.56	0.4603	2.06
2.1	2.11629	85.34	2.0883	84.33	1.1045	1.01	0.4313	85.34	0.4773	84.33	0.4313	1.01
2.2	2.21745	89.13	2.2635	89.03	1.0663	0.09	0.4041	89.13	0.4415	89.03	0.4041	0.09
2.3	2.31828	93.37	2.4445	93.36	1.0799	0.39	0.3783	93.37	0.4090	93.36	0.3783	0.39
2.4	2.41876	98.46	2.6402	97.44	1.0673	0.35	0.3549	98.46	0.3785	97.44	0.3549	0.35
2.5	2.51777	100.89	2.8501	101.56	1.0563	1.17	0.3336	100.89	0.3500	101.56	0.3336	1.17
2.6	2.61631	104.36	3.0751	108.05	1.0445	1.39	0.3114	104.36	0.3258	108.05	0.3114	1.39
2.7	2.71346	108.35	3.3169	110.10	1.0349	1.34	0.2914	108.35	0.3016	110.10	0.2914	1.34
2.8	2.80922	112.89	3.5745	114.13	1.0264	1.34	0.2736	112.89	0.2793	114.13	0.2736	1.34
2.9	2.90351	116.43	3.8463	118.16	1.0193	1.33	0.2569	116.43	0.2593	118.16	0.2569	1.33
3.0	3.00000	120.45	4.1447	122.16	1.0131	1.33	0.2423	120.45	0.2413	122.16	0.2423	1.33

3.1	4.4048	184.56	4.4580	186.15	1.0090	1.19	0.9285	184.56	0.3243	186.15	0.9280	1.19
3.2	4.5164	186.08	4.7925	187.15	1.0041	1.13	0.9277	186.08	0.3078	187.15	0.9259	1.13
3.3	4.5188	186.09	5.1541	184.13	1.0038	1.04	0.9280	186.09	0.1940	184.13	0.9268	1.04
3.4	5.3205	187.17	5.3388	186.18	0.9984	0.56	0.9205	187.17	0.1905	186.18	1.0016	0.56
3.5	5.3205	148.19	5.3356	148.19	0.9987	0.48	0.1890	148.19	0.1681	148.19	1.0083	0.48
3.6	6.3203	146.31	6.3200	146.11	0.9954	0.40	0.1873	146.31	0.1565	146.11	1.0047	0.40
3.7	6.3244	149.38	6.3205	150.10	0.9947	0.33	0.1485	149.38	0.1433	150.10	1.0033	0.33
3.8	7.3288	153.44	7.3246	154.09	0.9943	0.35	0.1396	153.44	0.1363	154.09	1.0037	0.35
3.9	7.3290	157.50	7.3047	156.10	0.9942	0.30	0.1373	157.50	0.1285	156.10	1.0038	0.30
4.0	8.4351	161.57	8.4351	163.11	0.9943	0.14	0.1186	161.57	0.1179	163.11	1.0037	0.14
4.1	9.0535	165.08	9.1034	166.13	0.9945	0.10	0.1105	165.08	0.1099	166.13	1.0054	0.10
4.2	9.7193	170.07	9.7704	170.13	0.9948	0.06	0.1039	170.07	0.1084	170.13	1.0059	0.06
4.3	10.434	174.11	10.431	174.15	0.9955	0.04	0.0934	174.11	0.0954	174.15	1.0045	0.04
4.4	11.301	178.16	11.346	178.16	0.9960	0.	0.0937	178.16	0.0936	178.16	1.0040	0.0
4.5	12.026	182.19	12.027	182.19	0.9965	0.	0.0831	182.19	0.0836	182.19	1.0034	0.
4.6	13.009	186.23	13.043	186.21	0.9970	0.03	0.0774	186.23	0.0773	186.21	1.0030	0.03
4.7	13.893	190.27	13.894	190.23	0.9974	0.04	0.0731	190.27	0.0717	190.23	1.0035	0.04
4.8	14.376	194.30	14.309	194.30	0.9978	0.04	0.0673	194.30	0.0670	194.30	1.0032	0.04
4.9	15.393	198.33	15.399	198.30	0.9980	0.04	0.0633	198.33	0.0630	198.30	1.0030	0.04
5.0	17.140	202.36	17.169	202.33	0.9983	0.04	0.0594	202.36	0.0594	202.33	1.0017	0.04
5.1	18.237	206.39	18.425	206.35	0.9985	0.04	0.0549	206.39	0.0549	206.35	1.0015	0.04
5.2	19.747	210.43	19.773	210.38	0.9987	0.04	0.0504	210.43	0.0503	210.38	1.0013	0.04
5.3	21.195	214.45	21.519	214.41	0.9989	0.04	0.0471	214.45	0.0471	214.41	1.0011	0.04
5.4	22.760	218.46	22.773	218.44	0.9990	0.04	0.0439	218.46	0.0439	218.44	1.0010	0.04
5.5	24.418	222.49	24.439	222.47	0.9992	0.03	0.0405	222.49	0.0405	222.47	1.0008	0.03
5.6	26.319	226.53	26.328	226.51	0.9993	0.03	0.0374	226.53	0.0374	226.51	1.0007	0.03
5.7	28.141	230.56	28.159	230.54	0.9994	0.03	0.0354	230.56	0.0354	230.54	1.0006	0.03
5.8	30.132	234.59	30.209	234.57	0.9995	0.03	0.0331	234.59	0.0331	234.57	1.0005	0.03
5.9	32.405	238.09	32.421	238.00	0.9996	0.03	0.0308	238.09	0.0308	238.00	1.0004	0.03
6.0	34.794	243.05	34.793	243.04	0.9996	0.01	0.0287	243.05	0.0287	243.04	1.0004	0.01

x	Sinh x and cosh x		Tanh x and coth x		Sech x and cosech x	
	+				-	
		° /		°		° /
6.05	36.047	945.06	1.000	0	2.774×10^{-3}	945.06
6.10	37.849	947.08	1.000	0	2.678 "	947.08
6.15	39.698	949.09	1.000	0	2.582 "	949.09
6.20	40.084	951.11	1.000	0	2.495 "	951.11
6.25	41.594	953.13	1.000	0	2.408 "	953.13
6.30	43.080	955.14	1.000	0	2.325 "	955.14
6.35	44.558	957.15	1.000	0	2.244 "	957.15
6.40	46.171	959.17	1.000	0	2.166 "	959.17
6.45	47.829	961.18	1.000	0	2.091 "	961.18
6.50	49.558	963.20	1.000	0	2.018 "	963.20
6.55	51.336	965.22	1.000	0	1.948 "	965.22
6.60	53.188	967.24	1.000	0	1.880 "	967.24
6.65	55.110	969.25	1.000	0	1.815 "	969.25
6.70	57.058	971.27	1.000	0	1.752 "	971.27
6.75	59.136	973.28	1.000	0	1.691 "	973.28
6.80	61.269	975.30	1.000	0	1.632 "	975.30
6.85	63.468	977.31	1.000	0	1.575 "	977.31
6.90	65.746	979.33	1.000	0	1.521 "	979.33
6.95	68.119	981.34	1.000	0	1.468 "	981.34
7.00	70.570	983.36	1.000	0	1.417 "	983.36
7.05	73.109	985.37	1.000	0	1.368 "	985.37
7.10	75.739	987.39	1.000	0	1.319 "	987.39
7.15	78.473	989.40	1.000	0	1.274 "	989.40
7.20	81.226	991.43	1.000	0	1.230 "	991.43
7.25	84.215	993.43	1.000	0	1.187 "	993.43
7.30	87.260	995.45	1.000	0	1.146 "	995.45
7.35	90.366	997.46	1.000	0	1.106 "	997.46
7.40	93.058	999.48	1.000	0	1.074 "	999.48
7.45	97.009	1001.49	1.000	0	1.081 "	1001.49
7.50	100.50	1003.51	1.000	0	9.950×10^{-3}	1003.51
7.55	104.12	1005.53	1.000	0	9.605 "	1005.53
7.60	107.86	1007.54	1.000	0	9.271 "	1007.54
7.65	111.74	1009.56	1.000	0	8.949 "	1009.56
7.70	115.67	1011.57	1.000	0	8.638 "	1011.57
7.75	119.94	1013.59	1.000	0	8.337 "	1013.59
7.80	124.26	1016.00	1.000	0	8.048 "	1016.00
7.85	128.71	1018.02	1.000	0	7.773 "	1018.02
7.90	133.35	1020.03	1.000	0	7.499 "	1020.03
7.95	138.16	1022.05	1.000	0	7.238 "	1022.05
8.00	143.12	1024.06	1.000	0	6.987 "	1024.06
8.05	148.23	1026.07	1.000	0	6.744 "	1026.07
8.10	153.61	1028.09	1.000	0	6.510 "	1028.09
8.15	159.14	1030.11	1.000	0	6.284 "	1030.11
8.20	164.87	1032.13	1.000	0	6.066 "	1032.13
8.25	170.80	1034.14	1.000	0	5.855 "	1034.14
8.30	176.95	1036.15	1.000	0	5.651 "	1036.15
8.35	183.31	1038.17	1.000	0	5.455 "	1038.17
8.40	189.91	1040.18	1.000	0	5.266 "	1040.18
8.45	196.75	1042.20	1.000	0	5.088 "	1042.20
8.50	203.88	1044.22	1.000	0	4.906 "	1044.22
8.55	211.16	1046.24	1.000	0	4.736 "	1046.24
8.60	218.76	1048.25	1.000	0	4.571 "	1048.25
8.65	226.68	1050.27	1.000	0	4.413 "	1050.27
8.70	234.79	1052.28	1.000	0	4.260 "	1052.28
8.75	243.23	1054.30	1.000	0	4.111 "	1054.30
8.80	251.99	1056.31	1.000	0	3.966 "	1056.31
8.85	261.06	1058.33	1.000	0	3.825 "	1058.33

x	Sinh x and cosh x +		Tanh x and coth x		Sech x and cosech x -	
		\circ /		\circ		\circ /
8.90	970.46	261.24	1.000	0.	2.696×10^{-3}	260.84
8.95	980.19	269.26	1.000	0.	2.569 "	269.26
9.00	990.28	264.26	1.000	0.00	2.445 "	264.28
9.05	900.78	266.39	1.000	0.00	2.323 "	266.39
9.10	811.54	268.41	1.000	0.00	2.209 "	268.41
9.15	822.75	270.49	1.000	0.00	2.098 "	270.49
9.20	834.37	272.44	1.000	0.00	2.996 "	272.44
9.25	846.39	274.46	1.000	0.00	2.889 "	274.46
9.30	858.85	276.47	1.000	0.00	2.787 "	276.47
9.35	871.81	278.48	1.000	0.00	2.695 "	278.48
9.40	885.15	280.50	1.000	0.00	2.594 "	280.50
9.45	899.04	282.51	1.000	0.00	2.500 "	282.51
9.50	413.36	284.53	1.000	0.00	2.419 "	284.53
9.55	428.26	286.55	1.000	0.00	2.335 "	286.55
9.60	443.67	288.56	1.000	0.00	2.250 "	288.56
9.65	448.98	290.57	1.000	0.00	2.223 "	290.57
9.70	476.18	292.59	1.000	0.00	2.101 "	292.59
9.75	498.31	295.01	1.000	0.00	2.071 "	295.01
9.80	511.07	297.03	1.000	0.00	1.957 "	297.03
9.85	529.46	299.08	1.000	0.00	1.897 "	299.08
9.90	548.58	401.05	1.000	0.00	1.821 "	401.05
9.95	568.26	408.07	1.000	0.00	1.768 "	408.07
10.00	588.60	406.06	1.000	0.00	1.697 "	406.06
10.05	609.80	407.09	1.000	0.00	1.637 "	407.09
10.10	631.84	409.11	1.000	0.00	1.587 "	409.11
10.15	654.58	411.13	1.000	0.00	1.537 "	411.13
10.20	678.14	413.14	1.000	0.00	1.474 "	413.14
10.25	702.58	415.15	1.000	0.00	1.424 "	415.15
10.30	727.81	417.17	1.000	0.00	1.374 "	417.17
10.35	754.01	419.19	1.000	0.00	1.323 "	419.19
10.40	781.14	421.21	1.000	0.00	1.293 "	421.21
10.45	809.26	423.23	1.000	0.00	1.267 "	423.23
10.50	838.38	425.24	1.000	0.00	1.199 "	425.24
10.55	868.56	427.26	1.000	0.00	1.151 "	427.26
10.60	899.81	429.27	1.000	0.00	1.113 "	429.27
10.65	932.18	431.29	1.000	0.00	1.073 "	431.29
10.70	965.74	433.30	1.000	0.00	1.035 "	433.30
10.75	1,000.5	435.32	1.000	0.00	9.9652×10^{-4}	435.32
10.80	1,086.5	437.33	1.000	0.00	9.6478 "	437.33
10.85	1,073.8	439.35	1.000	0.00	9.3123 "	439.35
10.90	1,112.4	441.36	1.000	0.00	8.9692 "	441.36
10.95	1,152.5	443.38	1.000	0.00	8.6770 "	443.38
11.00	1,194.0	445.39	1.000	0.00	8.3750 "	445.39
11.05	1,237.0	447.41	1.000	0.00	8.0645 "	447.41
11.10	1,281.5	449.42	1.000	0.00	7.8087 "	449.42
11.15	1,327.5	451.44	1.000	0.00	7.5227 "	451.44
11.20	1,375.3	453.46	1.000	0.00	7.2711 "	453.46
11.25	1,424.8	455.47	1.000	0.00	7.0184 "	455.47
11.30	1,476.1	457.48	1.000	0.00	6.7747 "	457.48
11.35	1,529.2	459.50	1.000	0.00	6.5398 "	459.50
11.40	1,584.3	461.52	1.000	0.00	6.3120 "	461.52
11.45	1,641.4	463.53	1.000	0.00	6.0929 "	463.53
11.50	1,700.3	465.54	1.000	0.00	5.8811 "	465.54
11.55	1,761.5	467.56	1.000	0.00	5.6769 "	467.56
11.60	1,824.9	469.57	1.000	0.00	5.4797 "	469.57
11.65	1,890.6	471.59	1.000	0.00	5.2898 "	471.59

x	Sinh x and cosh x +		Tanh x and coth x		Sech x and cosech x -	
		$\circ /$		\circ		$\circ /$
11.70	1,958.6	474.01	1.000	0.00	5.1056×10^{-4}	474.01
11.75	2,089.1	478.08	1.000	0.00	4.9888 "	478.08
11.80	2,198.1	478.04	1.000	0.00	4.7871 "	478.04
11.85	2,177.8	480.05	1.000	0.00	4.5910 "	480.05
11.90	2,256.1	482.07	1.000	0.00	4.4388 "	482.07
11.95	2,337.3	484.09	1.000	0.00	4.2784 "	484.09
12.00	2,421.5	486.10	1.000	0.00	4.1397 "	486.10
12.05	2,509.6	488.12	1.000	0.00	3.9939 "	488.12
12.10	2,598.9	490.14	1.000	0.00	3.8478 "	490.14
12.15	2,689.6	492.15	1.000	0.00	3.7141 "	492.15
12.20	2,780.0	494.17	1.000	0.00	3.5926 "	494.17
12.25	2,869.7	496.18	1.000	0.00	3.4805 "	496.18
12.30	2,958.7	498.20	1.000	0.00	3.3808 "	498.20
12.35	3,014.4	500.21	1.000	0.00	3.2948 "	500.21
12.40	3,113.1	502.23	1.000	0.00	3.2148 "	502.23
12.45	3,228.8	504.24	1.000	0.00	3.1409 "	504.24
12.50	3,448.5	506.26	1.000	0.00	3.0798 "	506.26
12.55	3,578.6	508.27	1.000	0.00	3.7991 "	508.27
12.60	3,701.1	510.29	1.000	0.00	3.7019 "	510.29
12.65	3,834.3	512.31	1.000	0.00	3.6090 "	512.31
12.70	3,973.6	514.33	1.000	0.00	3.5173 "	514.33
12.75	4,115.3	516.33	1.000	0.00	3.4269 "	516.33
12.80	4,268.4	518.35	1.000	0.00	3.3455 "	518.35
12.85	4,416.8	520.37	1.000	0.00	3.2641 "	520.37
12.90	4,575.7	522.38	1.000	0.00	3.1854 "	522.38
12.95	4,740.5	524.39	1.000	0.00	3.1095 "	524.39
13.00	4,911.0	526.41	1.000	0.00	3.0362 "	526.41
13.05	5,087.3	528.43	1.000	0.00	2.9655 "	528.43
13.10	5,270.9	530.44	1.000	0.00	2.8972 "	530.44
13.15	5,460.6	532.45	1.000	0.00	2.8313 "	532.45
13.20	5,657.0	534.47	1.000	0.00	2.7677 "	534.47
13.25	5,859.5	536.49	1.000	0.00	2.7061 "	536.49
13.30	6,071.6	538.50	1.000	0.00	2.6470 "	538.50
13.35	6,290.1	540.51	1.000	0.00	2.5898 "	540.51
13.40	6,516.5	542.53	1.000	0.00	2.5346 "	542.53
13.45	6,751.0	544.55	1.000	0.00	2.4813 "	544.55
13.50	6,993.9	546.57	1.000	0.00	2.4298 "	546.57
13.55	7,245.5	548.58	1.000	0.00	2.3801 "	548.58
13.60	7,506.4	551.00	1.000	0.00	2.3323 "	551.00
13.65	7,776.4	553.01	1.000	0.00	2.2869 "	553.01
13.70	8,056.4	555.03	1.000	0.00	2.2432 "	555.03
13.75	8,346.2	557.05	1.000	0.00	2.1992 "	557.05
13.80	8,646.7	559.06	1.000	0.00	2.1565 "	559.06
13.85	8,957.8	561.07	1.000	0.00	2.1164 "	561.07
13.90	9,280.3	563.09	1.000	0.00	2.0776 "	563.09
13.95	9,614.1	565.11	1.000	0.00	2.0405 "	565.11
14.00	9,960.2	567.12	1.000	0.00	2.0040 "	567.12
14.05	10,318	569.14	1.000	0.00	9.6914×10^{-3}	569.14
14.10	10,690	571.15	1.000	0.00	9.3547 "	571.15
14.15	11,075	573.16	1.000	0.00	9.0296 "	573.16
14.20	11,473	575.18	1.000	0.00	8.7160 "	575.18
14.25	11,886	577.20	1.000	0.00	8.4132 "	577.20
14.30	12,314	579.21	1.000	0.00	8.1210 "	579.21
14.35	12,757	581.23	1.000	0.00	7.8399 "	581.23
14.40	13,216	583.24	1.000	0.00	7.5666 "	583.24

x	Sinh x and cosh x +		Tanh x and coth x		Sech x and cosech x -	
		o /		o		o /
14.45	13,698	585.25	1.000	0.00	7.8087 × 10 ⁻³	585.25
14.50	14,184	587.87	1.000	0.00	7.1500 "	587.87
14.55	14,686	589.99	1.000	0.00	6.8050 "	589.99
14.60	15,204	591.80	1.000	0.00	6.5687 "	591.80
14.65	15,773	593.28	1.000	0.00	6.3405 "	593.28
14.70	16,389	595.34	1.000	0.00	6.1208 "	595.34
14.75	16,987	597.85	1.000	0.00	5.9077 "	597.85
14.80	17,586	599.87	1.000	0.00	5.7094 "	599.87
14.85	18,187	601.89	1.000	0.00	5.5044 "	601.89
14.90	18,823	603.40	1.000	0.00	5.3180 "	603.40
14.95	19,498	605.41	1.000	0.00	5.1385 "	605.41
15.00	20,200	607.43	1.000	0.00	4.9854 "	607.43
15.05	20,927	609.44	1.000	0.00	4.7785 "	609.44
15.10	21,680	611.45	1.000	0.00	4.6180 "	611.45
15.15	22,460	613.48	1.000	0.00	4.4828 "	613.48
15.20	23,280	615.49	1.000	0.00	4.3690 "	615.49
15.25	24,106	617.50	1.000	0.00	4.1488 "	617.50
15.30	24,973	619.53	1.000	0.00	4.0040 "	619.53
15.35	25,873	621.54	1.000	0.00	3.8851 "	621.54
15.40	26,808	623.55	1.000	0.00	3.7810 "	623.55
15.45	27,798	625.57	1.000	0.00	3.6919 "	625.57
15.50	28,795	627.59	1.000	0.00	3.4780 "	627.59
15.55	29,808	629.00	1.000	0.00	3.3554 "	629.00
15.60	30,873	629.09	1.000	0.00	3.2890 "	629.09
15.65	31,987	629.04	1.000	0.00	3.1968 "	629.04
15.70	33,140	628.05	1.000	0.00	3.0170 "	628.05
15.75	34,321	628.06	1.000	0.00	2.9199 "	628.06
15.80	35,539	640.08	1.000	0.00	2.8110 "	640.08
15.85	36,846	642.10	1.000	0.00	2.7140 "	642.10
15.90	38,174	644.11	1.000	0.00	2.6200 "	644.11
15.95	39,546	646.12	1.000	0.00	2.5287 "	646.12
16.00	40,970	648.14	1.000	0.00	2.4410 "	648.14
16.05	42,443	650.16	1.000	0.00	2.3561 "	650.16
16.10	43,971	652.17	1.000	0.00	2.2740 "	652.17
16.15	45,558	654.18	1.000	0.00	2.1958 "	654.18
16.20	47,199	656.20	1.000	0.00	2.1190 "	656.20
16.25	48,890	658.22	1.000	0.00	2.0454 "	658.22
16.30	50,649	659.23	1.000	0.00	1.9740 "	659.23
16.35	52,473	659.24	1.000	0.00	1.9055 "	659.24
16.40	54,359	664.25	1.000	0.00	1.8400 "	664.25
16.45	56,316	666.25	1.000	0.00	1.7757 "	666.25
16.50	58,475	668.26	1.000	0.00	1.7100 "	668.26
16.55	60,444	670.21	1.000	0.00	1.6544 "	670.21
16.60	62,619	672.22	1.000	0.00	1.5999 "	672.22
16.65	64,873	674.24	1.000	0.00	1.5415 "	674.24
16.70	67,208	676.25	1.000	0.00	1.4879 "	676.25
16.75	69,626	678.26	1.000	0.00	1.4363 "	678.26
16.80	72,123	680.28	1.000	0.00	1.3863 "	680.28
16.85	74,737	682.40	1.000	0.00	1.3382 "	682.40
16.90	77,418	684.41	1.000	0.00	1.2917 "	684.41
16.95	80,203	686.43	1.000	0.00	1.2468 "	686.43
17.00	83,098	688.45	1.000	0.00	1.2035 "	688.45
17.05	86,090	690.47	1.000	0.00	1.1617 "	690.47
17.10	89,176	692.48	1.000	0.00	1.1214 "	692.48
17.15	92,327	694.49	1.000	0.00	1.0824 "	694.49
17.20	95,711	696.51	1.000	0.00	1.0448 "	696.51
17.25	99,149	698.53	1.000	0.00	1.0096 "	698.53

x	Sinh x and cosh x		Tanh x and coth x		Sech x and cosech x	
	+	$\frac{\circ}{/}$		$\frac{\circ}{/}$		$\frac{\circ}{/}$
17.80	108,790	700.54	1.000	0.00	9.7349×10^{-6}	700.54
17.85	106,490	702.55	1.000	0.00	9.8988 "	702.55
17.40	110,350	704.57	1.000	0.00	9.0708 "	704.57
17.45	114,320	706.59	1.000	0.00	8.7551 "	706.59
17.50	118,380	709.00	1.000	0.00	8.4510 "	709.00
17.55	122,590	711.01	1.000	0.00	8.1576 "	711.01
17.60	127,000	713.03	1.000	0.00	7.8741 "	713.03
17.65	181,870	715.05	1.000	0.00	7.6006 "	715.05
17.70	186,800	717.06	1.000	0.00	7.3365 "	717.06
17.75	141,310	719.07	1.000	0.00	7.0817 "	719.07
17.80	146,390	721.09	1.000	0.00	6.8366 "	721.09
17.85	151,550	723.11	1.000	0.00	6.5998 "	723.11
17.90	157,000	725.13	1.000	0.00	6.3710 "	725.13
17.95	162,660	727.13	1.000	0.00	6.1475 "	727.13
18.00	168,530	729.15	1.000	0.00	5.9283 "	729.15
18.05	174,580	731.17	1.000	0.00	5.7231 "	731.17
18.10	180,860	733.18	1.000	0.00	5.5329 "	733.18
18.15	187,390	735.20	1.000	0.00	5.3468 "	735.20
18.20	194,110	737.21	1.000	0.00	5.1517 "	737.21
18.25	201,100	739.23	1.000	0.00	4.9737 "	739.23
18.30	208,380	741.24	1.000	0.00	4.8000 "	741.24
18.35	215,880	743.26	1.000	0.00	4.6383 "	743.26
18.40	223,600	745.27	1.000	0.00	4.4728 "	745.27
18.45	231,550	747.29	1.000	0.00	4.3168 "	747.29
18.50	239,980	749.31	1.000	0.00	4.1671 "	749.31
18.55	248,690	751.33	1.000	0.00	4.0222 "	751.33
18.60	257,770	753.34	1.000	0.00	3.8825 "	753.34
18.65	266,840	755.35	1.000	0.00	3.7476 "	755.35
18.70	276,440	757.37	1.000	0.00	3.6174 "	757.37
18.75	286,590	759.38	1.000	0.00	3.4918 "	759.38
18.80	296,890	761.40	1.000	0.00	3.3698 "	761.40
18.85	307,580	763.41	1.000	0.00	3.2533 "	763.41
18.90	318,570	765.43	1.000	0.00	3.1434 "	765.43
18.95	329,990	767.44	1.000	0.00	3.0318 "	767.44
19.00	341,770	769.46	1.000	0.00	2.9280 "	769.46
19.05	354,000	771.47	1.000	0.00	2.8344 "	771.47
19.10	366,810	773.49	1.000	0.00	2.7393 "	773.49
19.15	380,010	775.50	1.000	0.00	2.6315 "	775.50
19.20	393,690	777.52	1.000	0.00	2.5401 "	777.52
19.25	407,850	779.53	1.000	0.00	2.4519 "	779.53
19.30	422,580	781.55	1.000	0.00	2.3667 "	781.55
19.35	437,780	783.57	1.000	0.00	2.2845 "	783.57
19.40	453,490	785.59	1.000	0.00	2.2051 "	785.59
19.45	469,810	787.60	1.000	0.00	2.1285 "	787.60
19.50	486,730	789.62	1.000	0.00	2.0546 "	789.62
19.55	504,280	791.63	1.000	0.00	1.9833 "	791.63
19.60	522,380	793.65	1.000	0.00	1.9153 "	793.65
19.65	541,220	795.66	1.000	0.00	1.8478 "	795.66
19.70	560,850	797.68	1.000	0.00	1.7837 "	797.68
19.75	580,980	800.09	1.000	0.00	1.6871 "	800.09
19.80	601,730	802.11	1.000	0.00	1.6819 "	802.11
19.85	623,390	804.13	1.000	0.00	1.6041 "	804.13
19.90	645,880	806.14	1.000	0.00	1.5484 "	806.14
19.95	669,070	808.15	1.000	0.00	1.4946 "	808.15
20.00	693,150	810.17	1.000	0.00	1.4426 "	810.17
20.05	718,090	812.18	1.000	0.00	1.3926 "	812.18
20.10	743,980	814.20	1.000	0.00	1.3449 "	814.20

x	Sinh x and cosh x +		Tanh x and coth x		Sech x and cosech x . -	
		$\frac{e^x + e^{-x}}{2}$		$\frac{e^x - e^{-x}}{e^x + e^{-x}}$		$\frac{2}{e^x + e^{-x}}$
20.15	770.710	816.21	1.000	0.00	1.2675×10^{-5}	816.21
20.20	798.440	818.23	1.000	0.00	1.2525 "	818.23
20.25	827.160	820.24	1.000	0.00	1.2090 "	820.24
20.30	856.940	822.25	1.000	0.00	1.1660 "	822.25
20.35	887.770	824.27	1.000	0.00	1.1264 "	824.27
20.40	919.730	826.29	1.000	0.00	1.0873 "	826.29
20.45	952.820	828.30	1.000	0.00	1.0498 "	828.30
20.50	987.120	830.32	1.000	0.00	1.0130 "	830.32

DISCUSSION.

Prof. A. G. WEBSTER: I should like merely to make a few remarks in appreciation of papers of this sort. It seems to me very striking how, in the last twenty years, theoretical electrical engineering investigation has turned off toward power transmission, and so very little has been done on transmission of signals. The Atlantic cable is just about where it was twenty-five or thirty years ago—I suppose Doctor Kennelly will admit that—and it seems to me that for this reason papers of this nature are very valuable. I think this is a case where a scientific man studying this problem could help the practical man very much. Of course, over land we have made very great progress in connection with electrical currents for the telephone. We have seen this put into practical use. We have seen improvements made that have brought a large amount of money. But the cable is just where it was; something must be done for the cable. How is it to be done? There is no use going on and having more expensive cables if the terminal apparatus is just as important as the cable. It seems to me that investigations of this sort are very important. I see one thing for which I am glad. There are a number of numerical data given there for which I think people who want to know something about cables in practical life, will be very grateful.

Mr. STONE: I should like to draw attention to the very interesting fact brought out in Professor Kennelly's paper with regard to the best angle between the e.m.f. and the current at the receiving end in the case of a cable, that is, a 45-deg. angle. This is exactly the angle which will cause that apparatus to throw back no reflected wave of energy. If the angle is anything else, either a positive or a negative wave will be thrown back into the cable and energy there absorbed. This probably is the chief reason why the apparatus described is the most efficient apparatus that could be placed at the receiving end of the cable.

The following papers were then presented:

THE THEORY OF IONIZATION BY COLLISION.

BY PROF. J. S. TOWNSEND, *Oxford University.*

There are some well-known phenomena which show that gases acquire the property of discharging electrified conductors when they are traversed by ions moving with high velocities. The conductivity produced in air by Lenard or Cathode rays are examples of the effects produced by negative ions. The ionization of gases by the positive and negative ions emitted by radio-active substances is another illustration of the same action. In these cases, in which the effects are easily recognized, the velocity of the ions is of the same order as that which would be acquired by ions in traveling freely between two points differing in potential by some thousands of volts. A full description of the properties of Cathode rays and the rays from radio-active substances is given in the recent work on Conduction of Electricity through gases by Prof. J. J. Thomson, and that on Radio-activity by Prof. E. Rutherford.

The theory of ionization by collision under the form in which it is here described has been proposed in order to explain some of the phenomena which occur in the development of the large currents in a gas. It can be shown that the molecules of a gas may be ionized by the impacts of ions that have acquired their velocity under electromotive forces of 10 or 20 volts. The theory has been tested experimentally and a number of investigations have been made from which it is possible to calculate the exact extent to which ionization is produced by the motion of positive and negative ions through gases at various pressures.

It would appear from the large effects which may be obtained by the collisions between ions and molecules of a gas that the process of ionization under consideration is of fundamental importance in producing conductivity in many cases, and the theory will help to explain some of the complicated phenomena which occur in a conducting gas. The results of the investigations

[106]

have also thrown some light on the general properties of the ions that are formed in gases, and some remarkable differences between positive and negative ions can be thereby established.

The process of ionization by the collisions between ions and molecules of gases may be examined in a very simple manner by studying the conductivities which take place between parallel plate electrodes when ultra-violet light falls on the negative electrode. A number of negative ions are set free by the action of the light on the metal which travel through the gas to the opposite electrode. If the gas is at a high pressure the current between the plates increases with the electromotive force and approaches a certain maximum value which is attained when all the ions generated by the light reach the positive electrode. By reducing the pressure of the gas and increasing the electric force it is possible to make the ions travel with sufficient velocity to generate others by collisions with the molecules of the gas. Similar experiments can be made by producing ions in the gas by Rontgen rays or Becquerel rays.

It was a study of the changes which take place in the conductivity of gases through which ions are passing under varying conditions of pressure and electromotive force which first led to the theory of collisions. In all such cases when a suitable pressure is chosen it is easy to observe three stages as the electric force is increased. There is no definite point at which one stage ends and the other begins; the changes from one to another are gradual.

In the first stage the current between the plates increases with the electromotive force. The rate of increase diminishes as the force gets large and the current tends to attain a maximum value.

In the second stage the current remains practically constant and shows only small variations for comparatively large changes in the force. If the ions are produced by the action of Rontgen rays or Becquerel rays the constant value is attained when the force is sufficiently great to collect all the positive and negative ions on the electrodes. Before this value is attained an appreciable proportion of the ions is lost by recombination. Or again, the ions may be produced by the action of ultra-violet light on the electrode. If the force is too small some of the negative ions are lost by diffusion at the negative electrode but when it is sufficiently increased the maximum current reached in the second stage is attained.

In the third stage, when the force is still further increased there is a rapid increase in the conductivity. The phenomena are complicated, but can all be explained by the hypothesis that new ions are generated by collision, in the first instance practically by negative ions alone, but that as the force increases and the sparking potential is approached, the positive ions also gain the power of producing others in appreciable numbers. The theory also affords an accurate explanation of the sparking potentials for parallel plate electrodes under various conditions of pressure and distance between the plates.

Experiments have shown that in all gases it requires much larger electric forces to produce new ions by the impacts of positive ions than by those of negative ions; this doubtless arises from the fact that the latter are of much smaller mass; they have, however, the same charge as the positive ions, and therefore acquire high velocities along their free paths between collisions.

It will be convenient then, both from a theoretical and practical point of view to examine first the effects produced by the negative ions, and this may be done by a study of the cases in which the positive ions do not contribute to the ionization.

The simplest conditions are realised when the conductivity takes place between two parallel plates and a beam of ultra-violet light acts on the negative electrode. If the beam of light is narrow and is allowed to fall on a small area near the centre of the plate, the ions will travel in a uniform field of force, the diameter of the plates being large compared with their distance apart. Let each negative ion produce x new ions in moving through a centimetre of gas. If n_0 ions start from the negative electrode, $n_0 e^{x \times d}$ will reach the positive electrode, provided the negative ions produced in the gas are exactly similar to the original n_0 ions which are produced at the negative electrode by the ultra-violet light, d being the distance between the electrodes. Now the quantity x depends on the pressure p of the gas and the electric force X , and should therefore remain constant when the distance between the plates is varied if the difference of potential is changed in the same ratio. Consequently, when the pressure and electric force are unaltered, the current between the plates should increase in geometrical progression when the distance between the plates increases in arithmetical progression. This has been verified experimentally over large ranges of pressure and electric force.

The value of x can be found from determinations of the current c at different distances since

$$\frac{c_1}{c_2} = \frac{n_1}{n_2} = e^{x(d_1-d_2)}.$$

In cases where the initial ionization does not take place only at an electrode, but extends uniformly through the space between the electrodes, as is approximately the case when Rontgen rays or Becquerel rays pass through the gas, the effect of the negative ions may be found experimentally as follows: If n is the number of negative ions produced by the rays between the plates, the total number n of negative ions that are formed in the gas is $n_0 \frac{e^{x \times d} - 1}{x \times d}$

Hence if c_0 is the current in the second stage and c the current for an increased force X , when ions are being produced by collisions, the value of x may be found from the equation

$$\frac{c}{c_0} = \frac{e^{x \times d} - 1}{x \times d}.$$

When equal numbers of positive and negative ions are produced in a gas it would not be possible to decide from experiments with parallel plate electrodes whether the increases in conductivity obtained by increasing the force should be attributed to the positive or negative ions. This point has, however, been investigated by independent experiments with electrodes of different shapes, in which the gases were ionised by Rontgen rays and it has been shown that the effect must be due to the negative ions. If the gas is contained inside a spherical conductor which acts as one of the electrodes, the other electrode being a small sphere near the centre, or if the gas is contained between electrodes consisting of a large metal cylinder and a small coaxial cylinder, then for a small difference of potential the current is the same in both directions and corresponds to the total number of ions generated uniformly throughout the gas by the rays; but when the difference of potential is large this is no longer the case. It was found that when the large electrode is negative and the electromotive force is increased a large increase in the current is obtained. In this case all the negative ions produced by the rays traverse a field of strong electric

force in the neighborhood of the small electrode and acquire sufficient velocity to generate others by collision. But when the large electrode is positive and similar increases in electromotive force are made, the corresponding increases in current are much smaller. In this case only a few of the negative ions produced by the rays pass through the field of strong electric force and consequently the increase of conductivity is small. With suitable values of forces and pressures the current obtained when the outer electrode is negative may easily be ten or twenty times as great as that obtained with the same difference of potential when the outer electrode is positive.

The large increases in conductivity which may be obtained by increasing the force between parallel plate electrodes when Rontgen rays pass through the gas must therefore be due to the negative ions.

A conclusion of some importance can be immediately drawn from the results of experiments made with different gases. When ultra-violet light acts on the negative electrode setting free n_0 negative ions, it has been found that the number n that reach the positive electrode is given accurately by the equation, $n = n_0 e^{x/d}$ for various distances d between the plates, provided the electric force and pressure are kept constant.

The factor $e^{x/d}$ by which the current is increased when the distance between the plates is increased from d to $d + x$, is independent of the distance d and of the ratio $(n - n_0) : n_0$.

It follows therefore that the new ions $n - n_0$ generated from the molecules of the gas are precisely the same in their power of generating new ions as the original n_0 ions generated by the action of the light on the zinc plate. Since the charges on these ions are all the same it may be deduced that their masses are the same. Hence the negative ions produced in different gases by collision are all the same, being identical with the negative ions set free from a zinc plate by the action of ultra-violet light. This general conclusion can also be extended to the negative ions produced from the molecules of different gases by the action of Rontgen rays. since the values of x for the latter ions are the same as the values found for the same gas when conducting under the action of ultra-violet light.

For each gas the values of x corresponding to different values of X and p may be represented by means of a single curve. The

theory shows that the three quantities x , X , and p should be connected by an equation of the form $\frac{x}{p} = f\left(\frac{X}{p}\right)$ and the numbers found experimentally satisfy this condition. The following is a sketch of the proof.

In passing through a centimetre of a gas an ion traverses free paths of various lengths between the collisions. The chance of producing a new ion by collision will depend upon the velocity at impact and this is determined by the product of the force X and the length of the path which is terminated by the collision. The lengths of the free paths are inversely proportional to the pressure so that if the pressure is increased from p to $z \times p$, all the free paths will be reduced to $\frac{1}{z}$ of their original value. If the force remained unaltered, the velocities on collision would be reduced, but if the force is increased to $z \times X$, the velocities will be restored to their original values and the number of ions arising from a given number of collisions will be the same as before. Since the total number of collisions per centimetre is increased by increasing the pressure the value of x will therefore be increased to $z \times x$ when X and p become $z \times X$ and $z \times p$ respectively. Hence the three variables are connected by an equation of the form $\frac{x}{p} = f\frac{X}{p}$. From a graphic representation of the values of $\frac{x}{p}$ and $\frac{X}{p}$ it is easy to see that the values of x found experimentally satisfy this equation. The points whose co-ordinates are $\frac{x}{p}$ and $\frac{X}{p}$ all lie on the same curve whose equation is $y = f(x)$, so that practically the three variables are reduced to two, $\frac{x}{p}$ and $\frac{X}{p}$. The value of x for any force and pressure may be deduced from the curve.

The properties of the curves are in general agreement with the indications which are given by the theory. The co-ordinates of the curve $y = f(x)$ are the number of ions produced per centimetre and the electric force when the gas is at unit pressure, p being for simplicity taken as unit pressure, which in the experiments made was fixed as that due to a column of mercury a millimetre high. The curve therefore gives the values of x corresponding to different forces for the constant pressure $p = 1$ and its properties

may be examined from this point of view. For small forces the quantity x practically vanishes; the ions in this case do not acquire sufficient velocity along their free paths to generate others by collisions. As the force increases, x increases and approaches a maximum value which should be attained when the force is very large and a new pair of positive and negative ions are generated at each collision. The maximum value of x represents the total number of collisions that an ion makes in going through a centimetre of the gas. A remarkable result which appears from the experiments is that only one pair of new ions can be produced when a negative ion collides with a molecule even when the velocity at impact is very large.

The form of the function f which connects x and X may be obtained approximately from the following investigations. Let it be supposed that one pair of new ions are formed when the velocity at collision exceeds a certain value. Also let it be assumed that the velocity of a negative ion is so much reduced by colliding with a molecule that it practically starts from rest along its new path. An ion will then acquire the requisite velocity under a force X if it travels freely along a distance y , such that $y \times X$ is not less than V , where V denotes a constant difference of potential. Let the gas be at a pressure of one millimetre and let N be the number of encounters that a negative ion makes with molecules of the gas when it travels through a distance of one centimetre. The mean free path will be $\frac{1}{N}$ and the number of paths which exceed the distance y will be $N e^{-N \times y}$. The fall of potential along the path y will be equal to V when $y = \frac{V}{X}$, so that the number of ions which a single ion generates in going through a centimetre will be $N e^{-\frac{NV}{X}}$. This is the value of x corresponding to X when $p = 1$, hence the equations of the curves for different gases should be of the form $x = N e^{-\frac{N \times V}{X}}$ where N and V are constants to be determined by any two points on the curves. This formula agrees with the values found for x for the larger forces. The following table gives the numbers found experimentally for air corresponding to various forces, the pressure being one millimetre and also the values of the quantity $N e^{-\frac{N \times V}{X}}$. The forces X are given in volts per centimetre.

AIR. $N=15.2$, $V=25.0$ volts.

X	1400	800	600	400	200	100	70
z	12	9.4	7.9	5.8	2.5	.78	.25
$N_e \frac{-N \times V}{X}$	11.6	9.4	8.0	5.8	2.2	.88	.07

The following are the values of N and V which are in accordance with the results for the gases which have been examined.

VARIOUS GASES.

Gas	Air	H ₂	CO ₂	HCl	H ₂ O
N	15.2	5.5	18.9	22.2	12.7
V	25.0	25.1	22.9	16.5	20

It will be noticed that the formula $z = N_e \frac{-N \times V}{X}$ is not in agreement with the experimental results for the smaller forces; it is necessary therefore to modify the theory in order to obtain an explanation of the results over the whole range of forces. Now it has been assumed that two new ions, one positive and one negative, are produced by collision on all occasions when the velocity of the negative ion exceeds a certain fixed value; but it is probable that there are other circumstances besides the velocity of the negative ion which determine what takes place on collision, and if so, that ions may be produced on some occasions when the negative ion collides with a comparatively small velocity. The experimental results for the smaller forces may be explained on this supposition, and a formula can be obtained agreeing with the values of z over the whole range of forces on the assumption that the total numbers of collision have the values of N as given above.

The actual falls of potential required to explain the experimental results are in the case of hydrogen 20 volts and in other gases 5 or 10 volts; that is, it is supposed that on some occasions new ions are produced when the velocities attained are those due to these potentials, and that the probability of producing new ions increases as the velocity rises above these values.

The mean free paths of the negative ions in the different gases at a millimetre pressure are the reciprocals of the numbers N . As might be expected, the mean free path is longer in hydrogen than in the other gases and longer in water-vapor than in air, carbonic acid, or hydrochloric acid gas. The mean free path of the negative ion is more than four times as long as the mean free path of a molecule traveling through the gas with a similar velocity. This fact and the large difference between the properties of positive and negative ions lead to the conclusion that the negative ions are smaller both as regards mass and linear dimensions than the molecules of the gas from which they are derived.

It follows therefore from the experiments that the negative ions which play such an important part in the conductivity of gases are all the same and smaller than the molecules of hydrogen. This result holds not only for a simple gas such as hydrogen, but also for gases which when dissolved in water dissociate into charged atoms, of which the negative is very much larger than a molecule of hydrogen, as happens in the case of hydrochloric acid.

The kinetic energy acquired by an ion along a free path can easily be found and an approximate value of the energy required to ionize a molecule by collision can be calculated from the above results. It has been shown that ions are produced on some occasions when the negative ion collides with the velocity acquired in traveling freely between two points differing in potential by 10 volts. The kinetic energy corresponding to this fall of potential is $\left(\frac{10 \times e}{300}\right)^2$ if e the charge on the ion is expressed in electrostatic units. The value of e may be taken to be 3×10^{-10} , so that the kinetic energy required to ionize a molecule is about 10^{-11} erg. The results which have been obtained show that the energy is of the same order for the molecules of the different gases, except hydrogen, for which apparently a somewhat greater amount of energy is required.

The accuracy of the above calculation rests on the assumption that the negative ion is practically reduced to rest at each collision with a molecule. This seems to be a reasonable supposition, since the mass of the molecule is very large compared with that of the negative ion, but cannot be taken as universally true. It is therefore impossible to find the energy required to ionize a molecule very accurately by this method, still it is highly probable that 2×10^{-11} erg is an upper limit of the energy required to ionize a molecule by collision with a negative ion. It may be seen from what follows

that the energy required to ionize a molecule by a positive ion is greater than this quantity.

So far the experiments from which the properties of the negative ions have been deduced were made over ranges of forces and distances between the plates for which the conductivity obtained by the aid of ultra-violet light, was given by the formula $n = n_0 \epsilon^{x \times d}$. When both the distance d and the quantity $\frac{X}{p}$ exceed certain limits, the conductivity increases more rapidly with the distance between the plates than the above formula indicates. This effect can be accurately explained by supposing that the positive ions also take part in producing new ions. The phenomenon is well illustrated by the following experiments made with air at a millimetre pressure under a constant electric force of 350 volts per centimetre.

The current of electricity though the gas ceased immediately after the light was turned off when the distance between the plates was less than 11 millimetres.

EXPERIMENTS WITH AIR AT A MILLIMETRE PRESSURE.

d in centimetres	0	.2	.4	.6	.8	1.0	1.1
Current determined experimentally	—	2.96	8.27	24.2	81	273	2,250
$\epsilon^x \times d$	1	2.96	8.17	23.4	66.5	190	222
$\frac{(x-\beta) \epsilon^{(x-\beta)d}}{x-\beta \times \epsilon^{(x-\beta)d}}$	1	2.27	8.3	24.6	80	280	2,150

A comparison between the experimental results and the values of $\epsilon^{x \times d}$ ($x = 5.25$) for the different distances shows that it is only the conductivities at the smaller distances which can be explained by the action of the negative ions. A complete explanation of the conductivities for all the distances can be obtained on the supposition that the positive ions also play a part in producing new ions by collisions. When n_0 negative ions are started at the negative electrode and move to the positive electrode, a number $n_0 (\epsilon^{x \times d} - 1)$ positive and negative ions are generated from the molecules of the gas. Let each of the positive ions in its passage through the gas to the negative electrode produce β new ions per centimetre of its

path, the new ions thus produced being precisely similar to those produced by the negative ions. When β is small, a finite number of ions will be generated in the gas by these processes and all the negative ions reach the positive electrode in a small fraction of a second after the initial ions are started. It is easy to prove that the total number of ions n reaching the positive plate is then given

$$\text{by the equation } n = n_0 \frac{(x-\beta) e^{(x-\beta)d}}{x-\beta \times e^{(x-\beta)d}}.$$

The values of n according to this formula are given in the fourth line of the above table, taking $n_0 = 1$ and $x = 5.25$ as before, and $\beta = .0141$.

The proof of the theory rests in the first place on the agreement between these numbers and the ratios of the conductivities obtained experimentally. Several sets of experiments of the above kind have been made with air at pressures between half a millimetre and eight millimetres and a number of values of β were found corresponding to the different forces and pressures. Experiments have also been made with hydrogen with various forces over a range of pressures from one millimetre to 20 millimetres and these also are in agreement with the theory.

The following are some examples of the experiments that have been made with air and hydrogen. The distances d between the plates are given in centimetres and the currents c determined experimentally are given in arbitrary units. The numbers n are

calculated from the formula $n = n_0 \frac{(x-\beta) e^{(x-\beta)d}}{x-\beta \times e^{(x-\beta)d}}$, x and β being

found so that the formula should agree with the currents at three different distances, n_0 being taken as unity. It will be seen that the formula is in agreement with the experiments over the whole range of distances. The electric force X is given in volts per centimetre.

AIR. Pressure 2 mms.

d	.1	.2	.3	.4	.5
$X = 700, c$	2.9	8.3	28.8	80	274
$x = 1.05, n$ $\beta = .0282$	2.87	8.3	24.6	80	280

AIR. Pressure 4 mms.

d	.2	.3	.4	.5	.6	.7	.8
$X = 700, c$	5.12	11.4	26.7	61	148	401	1500
$x = 8.16,$ $\beta = .0037, n$	5.12	11.6	26.5	62	149	399	1544

HYDROGEN. Pressure 2 mms.

d	.4	.6	.8	1.0
$X = 262, c$	4.6	10.0	22.7	65
$x = 3.7,$ $\beta = .041, n$	4.55	9.9	22.7	67

HYDROGEN. Pressure 4 mms.

d	.2	.3	.4	.5
$X = 335, c$	4.6	9.9	22.8	66
$x = 7.4,$ $\beta = .062, n$	4.55	9.9	22.7	67

HYDROGEN. Pressure 16 mms.

d	.2	.3	.4	.5	.6
$X = 375, c$	4.5	9.4	21.4	50.8	153
$x = 7.46,$ $\beta = .0324, n$	4.5	9.7	21.4	51	149

It will be noticed that the values of x and β for air at two millimetres pressure, and a force of 700 volts per centimetre, are double those for air at one millimetre pressure, under a force of 350 volts per centimetre.

A similar proportionality between x and β may be seen from the first two sets of experiments given for hydrogen.

The values of β for each gas so obtained from a large number of

such experiments can be shown to be connected with the pressure and electric force by an equation of the form $\frac{\beta}{p} = \psi \left(\frac{X}{p} \right)$. This experimental result is further evidence in favor of the explanations which have been given of the phenomena, since it is necessary according to the theory that both the quantities α and β should be connected with the variables by the equations $\frac{\alpha}{p} = f \left(\frac{X}{p} \right)$ and $\frac{\beta}{p} = \psi \left(\frac{X}{p} \right)$, f and ψ being unknown functions to be determined experimentally.

From the nature of the experiments it is not possible to obtain as much definite information with regard to the positive ions as has been obtained from the negative ions. Investigations of a different kind have shown that the charges on all the ions, both positive and negative, in different gases, are all equal in magnitude. As regards mass and linear dimensions, it appears from these investigations that in gases, the positive ions are larger than the negative and probably differ in the different gases. Some evidence may be obtained on these points by comparing the values of α and β corresponding to air and hydrogen. Let it be supposed that a positive ion is about the same size as a molecule of the gas in which it is generated; so that at a quarter of a millimetre-pressure, a positive ion would make about as many collisions with molecules as a negative ion would make in the same gas at a millimetre pressure. For example, let the force acting on the ions be 100 volts per centimetre and let the positive ion travel through 10 metres of air at a quarter of a millimetre pressure, and the negative ion through the same distance of air at a millimetre pressure. From the experiments that have been made, it may be seen that under these conditions the negative ion would produce 700 ions and the positive ion would produce only six. This shows that among the same free paths 700 are sufficiently long to enable the negative ion to attain the velocity which is required for the genesis of new ions and only six are sufficiently long to enable the positive ion to acquire a similar property.

The difference between the positive and the negative ion is not so great in hydrogen as in air. A negative ion makes practically three times the number of collisions per centimetre in air that it makes in hydrogen, so that it is interesting to find the effects produced by a negative ion in hydrogen at a pressure of three millimetres when acted on by a force of 100 volts per centimetre and by a positive ion in hydrogen at three-quarters of a millimetre pressure under the

same force. The results of the experiments show that the negative ion would produce about 330 ions in 10 metres and the positive ion would produce 17. Since the negative ions are the same in air and in hydrogen, it may be deduced from these numbers that it requires a higher velocity of the negative ion to ionise the molecules of hydrogen than the molecules of air. It appears from the numbers obtained, that of the two positive ions produced in hydrogen and in air, the one which is produced in hydrogen differs least from the negative ion. This result would be expected if the negative ion is small compared with the positive ion in hydrogen, and the positive ion in hydrogen small compared with the positive ion in air.

The experiments have not yet been made for sufficiently large forces and small pressures to obtain the large values of $\frac{\beta}{p}$. At present, therefore, it is impossible to obtain more evidence as to the nature of the positive ions, but from the values of β that have been found, and from the theory that has been thereby established, it is possible to apply the results in other directions. Perhaps the most interesting is the explanation of 'sparking' which is furnished by the theory.

It has been already shown that when a number of negative ions starts from the negative of two parallel plate electrodes, the quantity which reach the positive is given by the formula $n = n_0 \frac{(x-\beta)\epsilon^{(x-\beta)d}}{x-\beta \times \epsilon^{(x-\beta)d}}$ the quantities x and β being determined by the experiments. The value of n becomes infinite when the denominator $x - \beta\epsilon^{(x-\beta)d}$ of the fraction vanishes. Hence when the distance is given by the formula $d = \frac{\log x - \log \beta}{x - \beta}$, the ions should continue to pass between the electrodes after the ultra-violet light is cut off, and sparking should ensue.

It is interesting to consider the result of substituting the values $p \times f\left(\frac{X}{p}\right)$ and $p \times \psi\left(\frac{X}{p}\right)$ for x and β in the formula $x - \beta \times \epsilon^{(x-\beta)d} = 0$ so that the condition for sparking becomes $\epsilon^{a \times p \times \psi\left(\frac{X}{p}\right)} \times f\left(\frac{X}{p}\right) = \epsilon^{a \times p \times f\left(\frac{X}{p}\right)} \times \psi\left(\frac{X}{p}\right)$, a being the value of d when sparking occurs,

The quantity $\frac{X}{p}$ is equal to $\frac{V}{m}$, where V is the difference of potential between the plates when sparking occurs and $m = a \times p$ is proportional to the mass of gas between the plates so that the formula takes

simple form $e^{m \times \psi\left(\frac{V}{m}\right)} \times f\left(\frac{V}{m}\right) = e^{m \times f\left(\frac{V}{m}\right)} \times \psi\left(\frac{V}{m}\right)$, which

gives the sparking potential V in terms of the product $a \times p$ and shows that the potential required to produce a spark between two parallel plates depends only on the amount of gas between the plates. It also shows that the sparking should be independent of the metal of which the electrodes are formed. The theory thus explains some properties of the sparking potential which were known to the earlier experimenters.

This property can also be deduced from a simple examination of the theory. When an ion starts from one electrode and traverses the gas the total number of collisions that occur depends only on the quantity m of gas between the electrodes. The fall of potential along any particular path is proportional to the fall of potential along the mean free path and therefore to $\frac{V}{m}$, V being the difference of potential between the electrodes. The two quantities V and m determine completely the ratio $\frac{n}{n_0}$ when the new ions are generated by the processes under consideration and the condition that $\frac{n}{n_0}$ should be infinite can therefore be expressed as a relation between V and m .

The validity of the theory as an explanation of the connection between the sparking potential and the quantity of gas between the plates can be tested accurately by experiment. Having determined the two quantities α and β for a given force X and pressure p the distance a between the plates at which sparking should occur is given by the equation $a = \frac{\log \alpha - \log \beta}{\alpha - \beta}$. The sparking potential $X \times a$ is therefore known for the pressure p and distance a . The potentials were thus determined theoretically over large ranges of pressures and distances between the plates and were found to be in accurate agreement with the sparking potential determined experimentally.

Fourteen determinations have been made with hydrogen over pressures from 20 millimetres to one millimetre and distances between the plates from 3.06 millimetres to 8.9 millimetres. The

sparking potentials determined experimentally differed on an average by 1.1 per cent from those calculated by the theory. The values of the product $p + a$ ranged from 8 to 128 and the potentials from 273 to 675 volts.

With air equally good results were obtained. Ten determinations have been made of sparking potentials over pressures from .66 to 8 millimetres and distances 4.3 to 11.3 millimetres, the product $p \times a$ being varied from 5 to 60. The average of the differences between the potentials determined theoretically and experimentally was in this case .52 per cent. The range of potential varied from 336 to 803 volts.

Further researches are being made on these lines, but as yet the theory has not advanced much beyond the stages which are here indicated.

It is probable that many of the phenomena connected with the passage of electricity through gases may be explained by the aid of the results which have been already obtained, as it appears from the investigations that the processes of ionization by collision are of fundamental importance in the development of an electric current through a gas.

Appended is a list of publications from which the leading principles and experiments described in this paper have been collected:
By Mr. Kirkby:

Electrical conductivity produced in air (between cylinders) by negative ions. *Philosophical Magazine*, February, 1902.

By the Author:

Conductivity produced by negative ions. *Nature*, August 9, 1900.

Conductivity produced in gases by the motion of negatively changed ions. (Air ionized by the aid of Rontgen rays). *Philosophical Magazine*, February, 1901.

Conductivity produced in gases by the aid of ultra-violet light. *Philosophical Magazine* (Air, H and Co_2) June, 1902, (H Cl & H_2O) April, 1903.

Some effects produced by positive ions. *Electrician*, 3d April, 1903.

Genesis of Ions by the motion of positive ions in a gas and a theory of the sparking potential. *Philosophical Magazine*, November, 1903.

By the Author and Mr. Kirkby:

Conductivity produced by the motion of negative ions (H & Co_2 ionized by the aid of Rontgen rays). *Philosophical Magazine*, June, 1901.

SPECTRA OF GASES AT HIGH TEMPERATURES.

BY PROF. JOHN TROWBRIDGE, *Harvard University.*

The new theories in regard to the complexity of the atom, together with a multiplicity of ionisation phenomena, make the results of Spectrum Analysis obtained by the discharges of electricity in glass or quartz tubes difficult of interpretation. To use ordinary language "so many things can happen," such as dissociation; combination with the gases set free from the walls of the containing tubes; masking of the spectrum of one gas by that of another, reversals of spectrum lines and so on.

These complicated conditions which accompany our study of gaseous spectra make it almost impossible to conclude from laboratory experiments that we have imitated the phenomena presented by the distant stars.

For several years I have been endeavoring to obtain new series of hydrogen lines which might presumably manifest themselves at very high temperatures. In the progress of this work I have obtained a number of interesting facts which I shall dwell upon in a brief manner in this paper; but I have failed to find a new series of hydrogen lines, possibly from the reason that the reactions both in glass and quartz vessels mask the series. It seems impossible to experiment at a higher temperature than I have obtained certainly if one employs such vessels as I have mentioned.

My investigations have been conducted with a storage battery of 20,000 cells, which were used to charge large condensers. The advantages in using a storage battery for experiments in spectrum analysis are well recognized. These advantages are especially seen in the employment of condenser discharges. When the condensers are charged through a large liquid resistance they charge to the same potential each time, and then discharge without the intervention of a discharger, through the Geissler tube. The number of discharges can be closely regulated by the amount of liquid resistance which connects the poles of the condensers to the battery. The regularity of such discharges through the Geissler tubes is re-

markable. In popular language one can call the arrangement an electric clock, for the discharges follow each other at regular intervals. In this way one avoids the spark at a discharger and is sure of always obtaining the same difference of potential at the ends of the Geissler tube.

The highest temperature to which one can submit a gas is presumably that of the electric discharge from a condenser; opinions differ in regard to the degree of heat which one can obtain by such a discharge. The limit I have reached is the volatilization of silica; perhaps 1800 degrees. At this temperature the spectrum shown by all gases in narrow capillary tubes consists of a continuous spectrum crossed by broad bands due to silica or to an oxide of silica; the gaseous spectra are completely masked. This masking seems to be due to the greater conductivity of the volatilization products from the walls of the tubes and from the metallic terminals. It seems to me that this variation in conductivity is sufficient to account for the phenomena of masking without recourse to a theory of electrons which provides for suitable damping of electrical oscillations. The electron theory may be an ultimate explanation, however, of electrical conduction.

When terminals of different metals are employed in capillary tubes of glass or quartz, and are separated four or five millimetres, complicated phenomena result from powerful condenser discharges through the rarified gases contained in these tubes.

All specimens of glass which I have tried, soft German glass, lead glass, Borsilicon glass, or Jena glass, give broad bands due to silica; lead glass gives, in addition, lead lines. Jena glass gives a very strong line of boron at wave length, 3451.49. These lines and bands are obscured by a continuous spectrum.

The narrow capillaries with metallic terminals, which I have used, may be called electric furnaces in which there is no permanent product or permanent decomposition; moreover the spectra which we observe do not reveal all that the capillaries contain. Hydrogen may be present; but it is concealed. Oxygen shows its presence only by probable oxides; the constituents of rarified air are undoubtedly always there. The conditions which prevail in the case of discharges in such narrow capillaries seem to be analogous to those in the case of discharges under liquids. In this latter case we also have reversals of metallic lines; and moreover certain characteristic lines of metals are wanting — See "Spectra

from the Wehnelt Interrupter," Harry W. Morse. *Proc. American Academy of Sciences*, May, 1904.

These results make one doubtful in regard to the entire subject of spark spectra which are observed between metallic terminals in ordinary air; and we are forced to ask, what influence does the environment have upon the character of these spectra — to what must we attribute the presence of oxygen? And even if we take spark spectra between metallic terminals in an atmosphere of hydrogen or nitrogen we are not sure that the results are not modified by the gases which are occluded in the metallic terminals.

Are we sure that, even in electrodeless tubes, helium is a product of disintegration of Radium; a transmutation, so to speak; and is not a result of the electrical stimulus in the environment of glass or quartz a stimulus which may bring to light the helium which has refused to manifest itself by chemical analysis?

In general it may be said that the greater the conductivity of the volatilization products either from the walls of the tubes or from the metallic terminals determine the occurrence of the spectral lines or bands. The spectrum, for instance, of silica completely masks the spectrum of the iron terminals when the latter are placed not more than five millimetres apart. When the terminals are of different metals the spectrum of the more volatilizable metal predominates: or more strictly the spectrum of the better conducting vapor.

Another striking fact brought to light by such discharges in capillaries is the reversal of many of the spectral lines on broad bands. The broadening of the lines of the metals is generally toward the red end of the spectrum. The quantity of the discharge appears to be the important factor in determining the character of the spectra; electromotive force, *per se*, does not give new lines which can be detected by photography. The effect of high electromotive force begins to be evident at high exhaustions and then only in producing cathode and X rays.

This latter fact can be well shown by a Tesla coil actuated by a Cooper-Hewitt mercury interrupter such as was employed by Dr. G. W. Pierce, *Proc. Am. Acad.* 1904. With a suitable step-up transformer, in connection with such an interrupter, I have studied the spectrum of hydrogen, and have not obtained a spectrum which differed from the one obtained by the same amount of energy with a lower voltage. The high voltage ranged from 100,000 volts to 3,000,000.

The broadening of metallic lines seems to indicate an oxidization. One can conceive of a loading of the metallic molecule by various degrees of oxidization which leads to a broadening towards the red end of the spectrum, or in other words to longer wave lengths, and an unloading due to dissociation which leaves the molecule free to emit shorter wave lengths. That an oxidization results from a discharge of electricity in glass or quartz tubes filled even with apparently dry hydrogen seems to me to be evident from my experiments. The unavoidable presence of water-vapor in glass, and I may add, in quartz tubes, lends color to this oxidization theory; this vapor is dissociated by the electric current, the oxygen, set free, combines with the molecules of the metals, or with the molecules of silica and its metallic impurities.

The following experiment illustrates this oxidization:

A Geissler tube, Fig. 1, with an internal diameter of one inch, was provided with an inner capillary, one end of which was blown to the walls of the larger tube; the other end was free inside this larger tube. An electric discharge passed between two ring electrodes A and B, which were placed in the larger tube. The discharge, therefore, started, so to speak, in the larger tube, passed through the narrow channel of the capillary and emerged to the cathode.

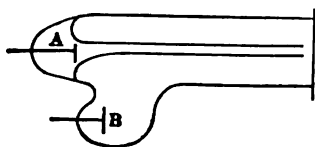

FIG. 1.

The tube was filled with pure hydrogen which was dried by phosphoric pentoxide. Under the effect of powerful condenser discharges, the four-line spectrum was much enfeebled in the capillary; the red color, characteristic of condenser discharges in hydrogen, gave place to a brilliant white light, and when the capillary was viewed end on, a continuous spectrum was seen. When, however, the discharge issued from the capillary a brilliant red aureole was seen around the end of the capillary. This aureole gave a much enhanced four-line spectrum. The temperature inside the capillary was sufficient to volatilize the walls of the capillary, and, therefore, was competent to decompose the water-vapor into oxygen and hydrogen. Just outside the end of the capillary, the temperature fell to the point of recombination of these gases to water-vapor.

In another experiment the Geissler tube G, Fig. 2, was placed between two manometer gauges, and was exhausted to such a degree that the electric discharge failed to pass. One end of the

Geissler tube, that nearest to the pump, was shut off by means of a stop cock B; and dry oxygen was admitted to the pump until the manometer gauge connected with the pump indicated two centimetres pressure. The stop cock was then opened so as to admit the gas to the Geissler tube. The corresponding manometer gauge at the opposite end of the Geissler failed to register the requisite equalization of pressure, there having arisen an oxidization of the mercury meniscus by means of which the capillary constant between it and the glass had been changed. This holding of the mercury meniscus was large and had to be overcome by vigorous tapping of the tube. An analogous effect was obtained when the Geissler tube was filled with rarified air, and also when it was filled with nitrogen. When, however, it was filled with dry hydrogen, the holding effect was comparatively inappreciable. The oxygen produced by the dissociative effect of the electric discharge combined with the hydrogen and no longer

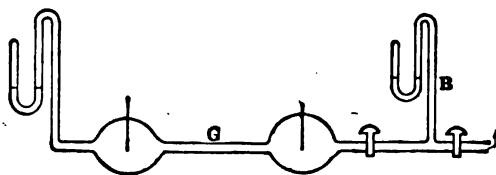

FIG. 2.

oxidized the surface of the mercury. In this connection it may be observed that the mercury meniscus in the Lippman electrometer is affected principally when it is made the positive pole, and, therefore, oxygen is liberated.

Perhaps the most striking experiment in this connection can be made with the steady current from a large storage battery. When Geissler tubes, preferably of half a centimetre internal diameter, are provided with copper terminals, and are filled with dry hydrogen at pressures of one millimetre to one-tenth of a millimetre, a steady diminution in the pressure of the gas results from the application of the discharge; the light of the spectrum grows dimmer and dimmer, then the cathode rays appear, finally the X rays, and then no discharge can be forced through the tube until a much higher electromotive force is employed, or heat is applied to the tube. This heat evidently drives off water-vapor from the walls of the tube together with air, a fresh application of the steady current again diminishes the pressure in the tube to an

apparent vacuum. Thus one can exhaust, so to speak, a Geissler tube by employing a steady current of electricity to dissociate the ever present water-vapor. With copper electrodes, the oxidization produced by this dissociation is more evident than with other metals; although I have observed it with magnesium terminals, with iron terminals and with other metals.

These experiments lead me to believe that, just as in chemical reactions, a certain amount of water-vapor or humidity is essential to conduction in gases whether brought about by what is called chemical affinity or electrolytic action.

I have dwelt upon the broadening of the lines of metals in capillary tubes. This phenomenon is also observed with hydrogen lines, and was first noticed by Liveing and Dewar, *Chem. News*, 47, p. 122, 1883. These authors attributed the broadening to compression of the gas in the narrow capillary under the effect of a powerful condenser discharge. Their method of experiment was as follows: The tube was exhausted only to perhaps five or six centimetres pressure, so that a white discharge of a spark nature passed through the capillary and then spread out to electrodes placed in the large ends of the tube. When the tube was viewed end-on, a continuous spectrum was seen in the capillary; moreover this continuous spectrum was crossed by a dark line which resulted from the absorption of heat in the colder layers of gas in the larger portions of the tube.

The broadening of the spectra of the vapors of metals which I have observed in capillary tubes has thus its analogy in the case of gaseous spectra.

Having obtained reversals of the spectra of metallic vapors under new conditions, I was naturally interested in the experiment of Liveing and Dewar, especially since a controversy had arisen between M. Cantor and E. Pringsheim in regard to the possibility of the reversal of gaseous lines in Geissler tubes. M. Cantor* concluded from his experiments that such reversals do not occur in the phenomena of luminescence, such as one obtains by the discharges of electricity in Geissler tubes. Pringsheim objected to these conclusions on the ground that Cantor did not observe a sufficiently narrow portion of the spectrum of the gas and did not use sufficient dispersion. Pringsheim† quotes the results of Liveing and Dewar in support of his position.

* *Ann. der Phys.* n. 3, 1900. p. 462.

† *Ann. der Phys.*, n. 5, 1900.

In repeating Liveing and Dewar's experiment, it occurred to me that objection might be brought against it on the ground that it was a spark discharge and not a clearly marked glow or luminescent discharge such as Cantor evidently had in mind. I therefore placed a second spark gap (Fig. 3, S) just outside the inner capillary of the large Geissler tube provided with an inner capillary, as I have previously described in speaking of the temperature inside a capillary and in the space just outside. The discharge passed first through the capillary and then by means of an outside connection through the second spark gap; thus the light from the capillary passed through the light from the second spark gap. In both cases the light was a glow or luminescence and not a white spark discharge, the pressure in the tube being from one to two centimetres.

A Rowland grating was employed and an eye piece was fixed on the C line of hydrogen. The second spark gap gave a fine bright

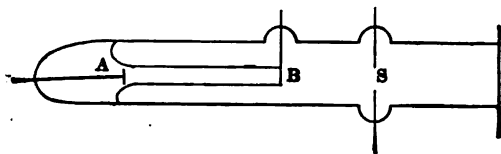

FIG. 3.

line of the apparent length of the slit, the capillary a continuous spectrum, and where the fine bright line crossed this continuous spectrum, it was reversed.

Kirchhoff's law of radiation thus applies to the radiation in Geissler tubes, and Pringsheim's contention is justified. If the solar corona is an electrical phenomenon of the nature of luminescence it can exhibit either bright lines or dark lines according as it is hotter or colder than the background.

In this study of the upper limit of temperature which one can reach by electric discharges through rarified gases, we perceive that spectrum analysis is one of the most difficult analyses which modern science has revealed. There are a few broad facts such as Doppler's principle and the reversal of spectral lines according to Kirchhoff's law; on the other hand there is ionisation, dissociation, adsorption and absorption, all modified by the glass or quartz vessels which must be employed.

M. Cantor calls attention to the fact that Hittorf failed also to observe reversals of spectral lines in the case of electric discharges

in Geissler tubes. Hittorf speaks of a first series of hydrogen lines which are seen with feeble discharges. This feeble spectrum with its bands seems to be a peculiarly luminescent effect in which any translatory or colliding effect of the molecules is a minimum. The new theories in regard to the composite nature of the atom seem to demand an extension of our views in regard to the nature of the light emitted by atoms and their aggregates under the stimulus of an electric discharge. The phosphorescent and fluorescent light of a gas under this stimulus may arise from the mechanism of the atom and therefore may not give sensible heat. The combination of atoms into molecules, and their dissociation and formation of new combinations, may give the spectra we usually observe under the effect of fairly strong electric discharges, and provide the sensible heat which can be measured by the bolometer or the thermal junction.

Spectrum analysis of the future thus becomes more and more difficult of application, and one of its most important fields is in the study of phosphorescent and fluorescent light emitted by gases. We seem to be on the point of regarding the light and heat of the sun more from the electrical standpoint. And the study of discharges of electricity in rarified gases assumes a great importance.

There being no discussion on the papers of Townsend and Trowbridge, the Section adjourned.

MORNING SESSION, Tuesday, September 13.

Joint session of Section A with the Institution of Electrical Engineers and the American Institute of Electrical Engineers.

Pursuant to adjournment, the Section was called to order at 9 o'clock, Prof. Edward L. Nichols presiding.

CHAIRMAN NICHOLS: The programme of this Section for this morning is to consist of certain papers on standards and systems of units, followed by a general discussion on these topics. The first of these papers is by Professor Ascoli, entitled "Systems of Electric Units."

VOL. I—9

ON THE SYSTEMS OF ELECTRIC UNITS.

BY PROF. M. ASCOLI, *President and Delegate of the Associazione
Elettrotecnica Italiana.*

1). I think that the International Electrical Congress should take cognizance of what has been done on the subject of electrical units since the last Congress. Therefore, I believe that a short report on the work done, especially in Italy, on this important question may not be without interest.

What I intend to say has nothing to do with any change which may be proposed of the value of the practical standard used at present. This paper is intended to deal with the fundamental theory of units.

2). In the equations of electromagnetism on which the definition of units is founded, we have several coefficients, to some of which we give particular values so as to establish particular systems of units. But I think it will be more useful in order to prevent any misunderstanding to keep at first all the coefficients in the formulæ, leaving to these their generality.

It is preferable, I think, in deducing the units to start from the old expressions of the laws of different kinds of mutual action between electric and magnetic quantities; that is to say, electrostatic, magnetic, electromagnetic, and electrodynamic actions.

We have thus four equations, one side of which is a force, expressing the laws of Coulomb, Laplace, and Ampere:

$$(1) \quad f = \frac{1}{\alpha} \frac{e^2}{r^2} \quad f = \frac{1}{\beta} \frac{m^2}{r^2} \quad f = \frac{1}{\gamma} \frac{m i d s}{r^2} \sin \omega$$

$$f = \frac{1}{\delta} \frac{i i' d s d s'}{r^2} \left(\cos \varepsilon - \frac{3}{2} \cos \theta \cos \theta' \right)$$

where the symbols have a well-known signification, and α , β , γ , δ , are special coefficients.

A fifth equation is

$$i = \frac{e}{t}$$

which can be said to express the equivalence between the current defined by electromagnetic action and the current defined by convection.

Many other equations frequently used may be considered as definitions of so many other magnitudes. For example

$$\begin{aligned}
 \text{Energy} &= eV && \text{defines the potential } V \\
 V &= iR && \text{defines the resistance } R \\
 e &= CV && \text{defines the capacity } C \\
 \text{Energy} &= \frac{1}{2}Li^2 && \text{defines the self-induction } L.
 \end{aligned}
 \tag{2}$$

In the preceding five equations we have seven magnitudes not having a geometrical or mechanical character, or, in other words, not depending only on the three fundamental magnitudes: length, mass, and time. These seven magnitudes are $e, m, i, a, \beta, \gamma, \delta$. We have five equations between seven quantities; two of them must, therefore, be chosen in order to have the others determined; and the choice must be an arbitrary one, until some new physical laws are discovered.

It has been, therefore, a misconception to suppose that length, mass, and time were sufficient to define the electric units. On the contrary, the fundamental magnitudes must be five in number. Three of them can be l, m, t ; the other two can be chosen in any way among the seven above-mentioned quantities, or others connected with them, by some known equations. It is not at all necessary to choose these two quantities among the coefficients a, β, γ, δ .

It has been suggested that it would be possible for new laws to be discovered in the future, so that even the coefficients above mentioned might be expressed in terms of l, m , and t . But in the present state of the science, this suggestion is entirely arbitrary. Mr. Fessenden, for instance, following Maxwell's conceptions, tried to assume that of the two coefficients a and β , the first could be a density, the second the reciprocal of a pressure; but Fessenden's arguments are at the utmost valuable only in suggesting the hypothesis of the proportionality between the said quantities, but not the hypothesis of their equality. In this way a new constant of unknown nature is introduced.

3). It is easy to deduce from the five equations above quoted¹ that the four coefficients, a, β, γ, δ , are connected by the two relations

1. See Prof. Somigliana, "Sulle unita elettriche e magnetiche." *Rendimenti dell' Institute Lombardo*. January, 1900.

$$(3) \quad \frac{\gamma^2}{a\beta} = v^2 \quad \frac{\delta}{a} = v^2$$

in which v represents a velocity that experiment proves to be dependent upon the nature of the matter occupying the region considered, and equal to the velocity of light in the same. Only two of the four coefficients can be chosen at will; that is to say two quantities are sufficient to define the electromagnetic properties of the surrounding matter, of the ether, for instance.

In the electrostatic system if we assume $a = 1$, $\gamma = 1$, it follows that $\frac{1}{\beta} = v^2$, $\delta = v^2$; in the electromagnetic system, if $\beta = 1$, $\gamma = 1$, it follows that $\frac{1}{a} = v^2$, $\delta = 1$. If we suppose $a = 1$, $\beta = 1$, as in a Hertzian system, we have $\gamma = v$, $\delta = v^2$.

Any system, provided that it satisfies the above conditions, is a rational one. It would be, therefore, preferable to choose a different word to indicate the system which gets rid of 4π from the formula of electromagnetism, suggested by Mr. Heaviside.

To obtain the rationalization, in the Heaviside sense, we must put $\gamma = 4\pi$ in the expression of the m.m.f. ($g = \frac{4\pi}{\gamma} i$) which follows from the third of the above equations. We have in this case, from

$$(3) \quad \frac{(4\pi)^2}{a\beta} = v^2$$

If together with this rationalization we wish also to keep unaltered the unit of electric quantity as chosen in the electromagnetic system, as was proposed by Fessenden, we must put $\frac{1}{a} = v^2$, as it is in this system; it follows that $\beta = (4\pi)^2$, as the value of the permeability of the standard medium, as Mr. Fessenden stated, notwithstanding the remedy of Professor Fleming. For this example we have a proof of the utility of the above method.

4). But the so-called rationalization, notwithstanding the proposals of Fleming and Fessenden, introduces some units that are not used in practice. So we will find it necessary to retain five different systems, unless we accept the proposal of Mr. Fessenden and assume the c.g.s. units also for practical purposes; but this change would itself be undoubtedly so objectionable, that I can hardly see how the proposal could be accepted.

Professor Giorgi of Rome took up the question more than three years ago in order to construct a system, rational in the Heaviside

meaning, but at the same time an absolute one; that is to say, depending upon a minimum number of fundamental units and having the advantage, essential for practical use, of keeping the units of the actual practical system for the measurement of the most important magnitudes.

The proposals of Mr. Giorgi were presented and discussed before the Associazione Elettrotecnica Italiana at the general meeting of October, 1901 (Rome). After this discussion a committee was appointed (Professors Ascoli, Donati, Grassi, Lombardi, Róiti), who presented a report also on behalf of the Italian Physical Society, at the general meeting of the Associazione in October, 1902 (Turin). The committee in this report expressed the opinion that the Giorgi system had the necessary characters which would entitle it to be substituted for the present systems, and recommended that the new system be brought before an international electrical congress.

In the meantime Mr. Giorgi has published some explanatory notes; the details of the system were given in the technical periodicals of Europe and America. It was also presented and discussed before the London Physical Society and a report of this discussion can be found in the London *Electrician*, in 1902. Professor Robertson subsequently returned in the same journal to the Giorgi proposals, and several authors, who took part in the discussion which ensued, seemed to have entirely forgotten the remarkable preceding work. Mr. Emde in Germany in an interesting paper on electric units read before the Elektrotechnische-Verein in Berlin some months ago (see E. T. Z.) discussed at length and favorably the Giorgi system.

The Giorgi system is a rational one (in the Heaviside sense); that is to say, it assumes the relation $\gamma = 4\pi$, and the coefficient γ is, therefore, one of the two magnitudes chosen in an arbitrary way. As regards the second outstanding magnitude, Mr. Giorgi proposed not one of the other coefficients, but one of the practical electrical units used at present; for instance the Chicago international ampere or ohm. In this case the ampere (or ohm) will no longer remain a unit theoretically defined, but it would become a fundamental arbitrary unit. In the same way, the meter is no more considered the ten-millionth of the terrestrial quadrant, but it is the length of the platinum bar existing in Paris which very approximately corresponds to the primitive definition.

The measurements of the earth, which at first were intended for the definition of the meter, now express in meters the length of the

quadrant. What would be now the result of measurements made for the determination of the absolute electric units, which required such long and hard labor? As has already been stated, among the quantities which are no longer arbitrary, we have the two coefficients, α and β ; that is, the electric and magnetic constants of the standard medium, of the ether, for instance. It would perhaps be better to change, in the work of the Chicago congress, the value of these constants instead of changing the value of the ohm previously employed.

5). It is easy now to see that, independently of the fundamental units of length, mass, and time, the units of e.m.f., resistance, capacity, inductance — that is, the most important ones in practical use — are not at all changed if we keep the same unit of time, energy (or power) and of electrical current (or resistance). In fact, this is plainly shown by the equations (3). For this reason we are free to choose any units of length and mass, provided that the unit of energy resulting from them remains the present joule; that is 10,000,000 ergs of the c.g.s. system. We can, therefore, choose as unit of length 10^n cm, and as unit of mass, 10^m grams, provided that $2n + m = 7$. We can take, for example, $n = 2$, $m = 3$, that is, take the meter and kilogram as units of length and mass. These units seem to be very appropriate because the Paris standards are precisely the meter and kilogram.

We have, in this way, the advantage of establishing a new system of rational units, keeping the practical system now used, and of reducing this system to an absolute one with very convenient fundamental units (meter, kilogram, and second).

Some may regret to give up the c.g.s. system, but it can be observed that the c.g.s. system is already partially abandoned in practice and that it will always retain its historical value because the arbitrary unit of current, (or resistance) that we would choose will have its origin in the old system.

If we suppose that the international ampere (or ohm) corresponds exactly to the theoretical definition depending upon the c.g.s. system, the electric and magnetic constant of the ether would be

$$\alpha = \frac{1}{36\pi} 10^{-9} \quad \beta = 4\pi 10^{-7}.$$

But in fact these constants are affected by the errors of observation made in the absolute measurements; if the 4π enters in the

expression of α and β , it occurs only from a historical reason, because the arbitrary unit is chosen very near to the value of a non-rational unit.

In conclusion, I believe that the Giorgi system must be preferred to the other rational systems which have been hitherto proposed. No difficulty of a legal kind exists against it, because none of the units accepted by the government are charged; on the contrary it prevents any change in the future. I do not think that it is necessary at present to introduce officially the new system, the more so as any one can use it without trouble of any sort; but I believe that the Congress should take cognizance of it, and put it on an official plane with other systems which have been proposed and may be proposed in the future. Especially I would like to call on it the attention of professors teaching electrical science.

APPENDIX.

PROPOSALS CONCERNING ELECTRICAL AND PHYSICAL UNITS.

BY PROF. G. GIORGL

It is suggested that the existing system of practical units may be completed as follows, thus making an absolute system of practical units:

1. *Concrete Electrical and Magnetic Units.*

Besides the existing units, ohm, coulomb, volt, farad, henry, and ampere, the following ones are proposed:

For *m.m.f.*, the ampere (already practically used under the name of ampere-turn).

For *magnetic flux*, the product of one volt by one second, which may be called the *weber* (as proposed by the British association).

For *magnetic inductance* (permeance, that is $\frac{\text{flux}}{\text{m.m.f.}}$), the henry (already existing as the unit of self-induction).

These, together with their reciprocals, make a complete and self-consistent system of electrical and magnetic concrete units. They may be combined with the following:

2. *Mechanical Units.*

For *length*, the meter.

For *mass*, the kilogram.

For *time*, the second.

Thence —

For *power*, the watt.

For *work*, the joule, etc., etc.

3. *Electrical and Magnetic Specific Units.*

No name for any specific unit is proposed. Instead of having specific units ready made, it is preferable to make them by referring the concrete units to any unit of length, area, volume, which may

be preferable, according to the circumstances of a case; thus, *volt/m*, or *volt/mm*, or *volt/inch* as it may be desirable.

When the meter, kilogram, and second are taken as fundamental, specific units of the absolute practical system result as follow:

Amp./m for magnetic force (magnetic field intensity, gradient of magnetic potential).

Volt/m for electric force (electric field intensity, gradient of electric potential).

Weber/m² for magnetic induction (magnetic displacement, magnetic flux per unit area).

Coulomb/m² for electric induction (electric displacement, electric flux per unit area).

Henry/m for magnetic inductivity (permeability, magnetic constant of a medium).

Remark.—The magnetic constant of free ether becomes $\mu_0 = 0.000,001,256$ henry/m.

Farad/m for electric inductivity (dielectric power, electrostatic constant, ratio of electric displacement to electric force).

Remark.—The electric constant of free ether becomes $k_0 = 0.000,000,000,008,842$ farad/m.

RESULTS.

In this manner we obtain an *absolute system of practical units*, which is independent of both the c.g.s. electrostatic system and the c.g.s. electromagnetic system, and does not interfere with either.

As fundamental units of this system there may be taken, the *meter*, the *kilogram*, the *second*, and the *ohm* (the latter to be defined by the practical standard adopted by the Congress of 1903, or by the standard kept at the Board of Trade in London).

This system is "rationalized" (in Mr. O. Heaviside's signification); that is, is free from any unnecessary 4π . In this system, electric current is identified with m.m.f.

This system is neither electrostatic nor electromagnetic, because neither the electric nor the magnetic constant of free ether is assumed as a fundamental unit.

This system is completely dualistic, all units having a magnetic and an electric signification at the same time, which halves the number of units needed; all electric and magnetic formulæ are identical.

All units, fundamental and derived, are of convenient size.

The system may be called the *absolute practical system*. Its units may be called *absolute practical units*.

CONCERNING PRACTICAL USE.

The system consists entirely of units already in practical use.

Practicians are not required to make any change, nor to learn anything new. They are simply to be instructed that their present units may also be used as absolute ones, thereby making the c.g.s. systems unnecessary in their calculations.

The necessity of making conversion of units is thus avoided (see Note C).

CONCERNING SCIENTIFIC USE.

Neither the c.g.s. electrostatic nor the c.g.s. electromagnetic system is touched. Scientists will be free to use any one of these systems, without modification, or to substitute for them the absolute practical system, with the advantage of simplified and rationalized formulæ; agreement with practical use; units of convenient size; dimensions simple, without fractional exponents; fundamental units independent of absolute measurement; no distinction to be made between electrostatic and electromagnetic calculations.

THEORETICAL GROUNDS.

The theoretical grounds on which the absolute practical system is founded are fully set forth and discussed in the papers mentioned in Note A.

The point of fundamental importance to be kept in view is the following:

In order to derive electric and magnetic units from mechanical units, a fourth fundamental or independent unit is necessary. In the c.g.s. electrostatic and in the c.g.s. electromagnetic systems, the fourth unit assumed is respectively the electrostatic or the magnetic constant of free ether; but this has many disadvantages. In the absolute practical system, the fourth unit is the *ohm*.

Of course, when any electric or magnetic unit is arbitrarily chosen, all others are deduced from it.

NOTE A.

History.

- 1). G. GIORGI.—“Unita Razionali di Elettromagnetismo,” read before the general meeting of the Italian Association of Electrical Engineers, October, 1901, in Rome. See *Atti dell' Associaz. Elettr. Italiana*, 1901, p. 402; *L'Elettricista*, 1901, December; *L'Elettricità*, 1901; *L'Industria*, 1901 (+); *Il Nuovo Cimento*, 1902. See also abstracts in *Science Abstracts*, in *l'Eclairage Electrique*, etc.
- 2). DISCUSSION OF SAME.—See report of said meeting, in *Atti dell' A. E. T.*, 1901.
- 3). G. GIORGI.—“Rational units of electromagnetism,” read before the Physical Society of London, on May 27, 1902.
- 4). DISCUSSION OF SAME.
- 5). PROF. DONATI.—Report on G. Giorgi's proposals. See *Nuovo Cimento*, 1902.
- 6). PROF. ASCOLI.—Sul Sistema di Unita Proposto dall' Ing. Giorgi, read before the Congress of the Societa Italiana di Fisica, held at Brescia in September, 1902.
- 7). DISCUSSION OF SAME. See *Nuovo Cimento*, 1902.
- 8). G. GIORGI.—“Il Sistema Assoluto M. Kg. S. Read before the A. E. T., May 2, 1902. See *Atti dell' A. E. T.*, October, 1902; *L'Elettricista*, 1902, etc.
- 9). REPORT OF COMMITTEE, appointed by the Associazione Elettrotecnica Italiana, and by the Societa Italiana di Fisica, consisting of Prof. Grassi, Prof. Ascoli, Prof. Roiti, Prof. Lombardi, Prof. Donati; read by Prof. M. Ascoli at the general meeting of the Italian Electrical Association, held in Turin, November, 1902; also discussion of the same. See report of the meeting in *Atti dell' A. E. T.*, 1902.
- 10). G. GIORGI.—“I Fondamenti della Teoria delle Grandezze Elettriche,” read before the said Congress. See *Atti dell' A. E. T.*, 1903. See also abstracts in *Science Abstracts* and elsewhere.
- 11). G. GIORGI.—“Le Formole Teoriche di Eletttricità,” read before the A. E. T., Dec. 15, 1902. See *Atti dell' A. E. T.*, 1903.
- 12). G. GIORGI.—Notazioni e simboli Elettrici. See *Atti dell' A. E. T.*, 1903.

NOTE B.

*List of Units of the Absolute Practical System.*1.) *Mechanical.*

Magnitudes.	Absolute practical units.
Length	m
Area	m ²
Volume	m ³
Time	sec
Frequency	sec ⁻¹
Velocity	m/sec
Acceleration	m/sec ²
Mass	kg
Density	kg/m ³
Force	(..... no name exists)
Torque	joule
Energy	joule
Power	watt

2.) *Electrical.*

Magnitudes.	Absolute practical units.
Quantity of electricity	coulomb
Electric displacement	coulomb/m ²
Electric current	amp.
E.m.f.	volt
El. force	volt/m
El. conductance	mho
El. conductivity	mho/m
El. resistance	ohm
Capacity	farad
El. inductivity (= specific capacity, or electric constant of a medium)	farad/m
Coefficient of self-induction	henry

3). *Magnetic.*

Magnitudes.	Absolute practical units.
Quantity of magnetism (flux)	weber
Magnetic induction	weber/m ²
Magnetic current ($-\frac{d\psi}{dt}$)	volt
M.m.f.	ampere
Magnetic force	amp./m
Magnetic inductance (= permeance = $\frac{\text{flux}}{M.M.F.}$)	henry
Magnetic inductivity (= magnetic constant of a medium, permeability)	henry/m
Magnetic reluctance	henry ⁻¹

NOTE C.— METHOD OF APPLICATION.

To Calculate the Capacity of the Earth in Farads.

a). Following the methods hitherto used.	b). Using the absolute practical system.
Radius of the earth $r = 6 \times 10^8 \text{ cm}$	Radius of the earth $r = 6 \times 10^6 \text{ m}$
Dielectric constant of free ether $k = 1$ (<i>electrostatic system</i>)	Dielectric constant of free ether $k = 88 \times 10^{-12} \text{ farad/m}$
Capacity of the earth, in c.g.s. electrostatic units $(K) = \frac{r}{k} = 6 \times 10^8$	Capacity of the earth $K = 4\pi kr = 67 \times 10^{-5} \text{ farad}$
Coefficient for converting electrostatic into electromagnetic value $v^2 = 9 \times 10^{20}$	
Capacity of the earth in c.g.s. electromagnetic units $[K] = \frac{(K)}{v^2} = \frac{6}{9} 10^{-12}$	
Coefficient for converting c.g.s. value into practical value $\epsilon = 10^9$	
Capacity of the earth in farads $K = \epsilon[K] = 67 \times 10^{-5} \text{ farad}$	

THE ABSOLUTE VALUE OF THE E.M.F. OF THE CLARK AND THE WESTON CELLS.

BY PROFESSORS HENRY S. CARHART AND GEORGE W. PATTERSON, *University of Michigan.*

A research made under a grant from the Carnegie Institution.

INTRODUCTION.

The method used by us in determining e.m.f.s. relies on the measurement by an absolute electro-dynamometer of a current through a known resistance. The resulting potential difference is compared by the potentiometer method with the e.m.f. of the cell under investigation. In our work we assume certain coils, marked 1 ohm, to have values given in the certificates of the Reichsanstalt which refer to them. The other experimental data: lengths, referred to a Rogers bar with Rogers certificate, masses, weighed with weights compared with weights with certificates from the United States Bureau of Weights and Measures, and time, obtained from a Rieffler clock in our laboratory, whose error is of too small an order to affect our results. The acceleration due to gravity does not enter our problem.

THE ELECTRODYNAMOMETER.

The electro-dynamometer is a two-coil instrument, each coil of which consists of a single layer of conductors wound on a cylinder. The same arrangement was used by Patterson and Guthe,¹ and Carhart and Guthe.² Our present instrument is of the same general design, but has its coils wound on plaster of paris cylinders instead of wood and vulcanite, as in our older instrument. The

1. Patterson and Guthe, *Proc. A. A. A. S.*, 1898, p. 154, and *Phys. Rev.*, December, 1898, Vol. VII, p. 257.

2. Carhart and Guthe, *Proc. A. A. A. S.*, 1899, p. 103, and *Phys. Rev.*, November-December, 1899, Vol. IX, p. 288.

diameter and length of each coil are in the ratio of 2 to $\sqrt{3}$. This ratio simplifies the computation for the torque between the coils.³ The following table shows the data for the two coils:

	Number of turns.	Mean diameter.	Mean length.	Conductor.
Fixed coil	598	47.879 cm.	41.006 cm.	} 0.062 cm. diam. } 0.069 cm. diam. over all. } 0.0375 cm. thick. } 0.126 cm. wide.
Movable coil.....	86	10.044 cm.	8.608 cm.	

The conductor of the suspended coil is copper ribbon, whose width is intended to be equal to the width of the space between turns. The effective length of this coil could not be determined with as great accuracy as the other dimensions, as it was not practicable to keep the distance between turns absolutely uniform. This lack of uniformity is very slight and leads to no appreciable error, as the length of the coil appears only as a correction when the ratio of length to diameter is $\sqrt{3}$ to 2.

The smaller coil is suspended by a wire whose torque balances the torque between the coils when the current to be measured is passing. It is our invariable rule to twist the wire one complete turn. Mirrors at both ends of the suspension, in conjunction with telescopes and scales at a distance of 2 meters, enable us to determine when the twist of the wire is as desired. At the distance chosen, 1 mm on the scale, as viewed through the telescope, corresponds to $1/25,133$ of a turn. An error of $1/250,000$ of a turn would be easy to detect. The real difficulty in our measurements is in the wire, however, for elastic fatigue and subpermanent set of the wire have caused us much trouble, and are still interfering with our obtaining satisfactory results. The suspending wire is permanently soldered into a small brass rod at one end and a larger brass cylinder at the other end. The brass rod may be coupled to the suspended coil, in which case the larger brass cylinder is held in the torsion head. To obtain the torsional constant of the wire, we turn the wire end for end, load the wire with a total mass equal to that of the suspended coil, by adding a hollow brass cylinder which closely fits the cylinder soldered to the wire, and clamp the brass rod in a support. We then determine the

3. A. Gray, "Theory and Pract. Absol. Meas. in Elect. & Mag.," Vol. II, part I, p. 275. Also Patterson, *Phys. Rev.*, 1905.

period of torsional vibration of the system. The moment of inertia of the system used is 2251.11 gm — cm², made up as follows:

Hollow cylinder	2241.65 gm — cm ²
Inner cylinder	9.39
Mirror07
	2251.11
	2251.11

The ratio of length to diameter of the combined outer and inner cylinders is $\sqrt{3}$ to 2, an arrangement which gives the same moment of inertia about all axes passing through the center of gravity of the cylinder. This insures freedom from error if the axis of the cylinder differs from the axis of suspension. In actual fact no appreciable difference between these axes occurs. The same cylinder was used by Patterson and Guthe (page 2), who also used a second cylinder of as nearly as practicable the same dimensions, and which gave concordant results, thus making it probable that the cylinders were free from blow-holes, which would hardly have had equal effects in both cylinders. We have used both phosphor bronze and steel wires for the suspension. The phosphor bronze wires had diameters about $\frac{1}{3}$ of a mm (0.30, 0.33, and 0.35). The steel wire was 0.28 mm in diameter. Our instrument is arranged to hold a suspension wire from 90 cm to 115 cm long. The length of wire should preferably be chosen so as to make the torque with one complete turn approximately that of the coils when the current through the instrument causes over the standard resistance a potential difference equal to the e.m.f. of the cell under test. This tends to eliminate the effect of any errors in the calibration of the potentiometer. We have concluded to lengthen the suspension wire to about 2 meters, using a wire of somewhat larger diameter. For one complete turn the torque is inversely proportional to the length and directly proportional to the fourth power of the diameter; and consequently a twist of one turn for the longer wire will cause much reduced shear in the wire, and we believe that by this means the effects of elastic fatigue and subpermanent set will be materially reduced. The effect of the set of the wire is to reduce the effective twist. As the square of the current is proportional to the twist of the wire necessary to hold the coil in its initial position, we

see that an error in the effective twist of 1 per cent corresponds to an error in the current of $\frac{1}{2}$ per cent; or, with the telescope and scale at 2 m distance, 1 cm error is equivalent to an error in the current of about 1 in 5000 (more exactly, 1 in 5026.6). The usual effect of the elastic fatigue has been to make the zero change by about 3 to 4 cm. With repeated twists in the same direction the uncertainty reduces to about 1 cm; but the question arises, "Is the rigidity of the wire the same as when undergoing torsional vibrations?" We hope soon to reduce the elastic fatigue to such a degree that we may feel safe in assuming the rigidity to be the same under both conditions.

We chose plaster of paris cylinders to hold the coils after experimenting with wood, vulcanite, and porcelain. Dr. Guthe was still with us when we chose plaster of paris for the support of the fixed coil, and he and one of us made a series of tests as to the magnetic neutrality of the plaster of paris. It appeared to be almost perfectly inert. Since making the suspended cylinder of plaster of paris, two other tests have been made. In one the cylinders were placed with axes at 45 deg. and the full current sent through the fixed coil. The movable cylinder did not turn appreciably, and it would have been easy to detect $1/250,000$ of a turn. Later the periods of torsional vibration of the suspended coil were determined with and without the full current in the fixed coil. The results reduced to the same temperature are 35.606 ± 0.001 sec. for the former and 35.607 ± 0.001 sec. for the latter. These results agree within the errors of observation, and we conclude that plaster of paris has unit permeability.

For one complete turn of a wire on which a mass of moment of inertia K executes torsional vibrations with a complete period T the torque is

$$T_1 = \frac{8 \pi^2 K}{T^2} \tag{1}$$

The action of a current I (c.g.s. units) through two cylindrical coils for which L, D, N , and l, d, n are length, diameter, and number of turns of conductor for each coil respectively, and where $L : D :: l : d :: \sqrt{3} : 2$, produces a torque,

$$T_2 = \frac{\pi^2 d^2 N n I^2}{\sqrt{L^2 + D^2}} \tag{2}$$

Equating these torques and solving for I we obtain

$$I = \frac{1}{Td} \sqrt{\frac{8\pi K}{Nn}} \sqrt{L^2 + D^2} \quad (3)$$

In deriving⁴ equation (2), it has been assumed that the coils are equivalent to current sheets, and it is well to inquire whether this assumption may be allowed. The fixed cylinder is wound with wire about 0.069 cm diameter, including a silk insulation, the bare wire being 0.062 cm in diameter. The suspended cylinder is wound with a ribbon 0.0375 cm thick and 0.128 cm wide, and the spaces between turns are approximately the same width as the ribbon. It follows that one-half of the winding has spaces corresponding to the ribbon on the other half, so that the average effect is that of a current sheet. We have assumed that it is proper to take as the effective diameter the arithmetical mean between the outer and the inner diameter; for, although the torque depends on the square of the radius for turns at various distances, we must recognize that the layer of the ribbon next to the cylinder is relatively shortened and that this produces a tendency to larger current density near the surface of the cylinder. It appears probable that one item offsets the other and that the mean radius is fairly taken as the arithmetical mean. The lead wires from the suspended coil to the mercury cups are in the plane normal to the axis of the fixed coil, and in the vertical plane through the axis of the suspended coil. It follows that they can exert no torque on the fixed coil. One mercury cup is over the other, and both are in the line of the suspending wire. The lead wires to the mercury cups from outside are twisted together except for the short space near the cups, where of necessity they are separated. Want of symmetry here may be eliminated by reversing the connection between the coils, and in our work it is always so eliminated. The winding of the fixed coil is wire of so small radius that the ripples in the magnetic field cannot be appreciable. The arithmetical mean between the outer and inner radii of the coil is taken for reasons similar to those mentioned in connection with the suspended coil. The lead wires to the fixed coil go to the ends of an element of the cylinder level with the axis, and are twisted together

4. For the derivation of this expression see Patterson, *Phys. Rev.*, 1905.

except for a piece parallel and near to this element. This piece can produce no torque about a vertical axis, and besides its effect is always equal and opposite in amount in symmetrically placed elements of the suspended coil.

The effect of the earth's magnetic field is eliminated by the reversal of the current through the whole instrument. We, therefore, obtain balances with all possible permutations of the current in the two coils—four balances in all. The differences among these four are appreciable, but of very small magnitude.

When we have succeeded in reducing the effect of elastic fatigue in the suspension to smaller values, we shall hope to reach results accurate to at least one part in 5000. For the present we are only prepared to say that the legalized value of the e.m.f. of the Clark cell (1.434 volts under standard conditions) is too high.

CHAIRMAN NICHOLS: Are there any remarks upon this paper of Professors Carhart and Patterson? If there are not, we will listen to the paper of Doctor Wolff on "International Electric Units."

DOCTOR WOLFF: The object of this paper is to briefly review the work of the previous Congresses, to bring together the laws enacted by the various governments, to set forth their inconsistencies, and to point out the need of some action which will bring about international uniformity.

THE SOCALLED INTERNATIONAL ELECTRICAL UNITS.

BY DR. FRANK A. WOLFF, *National Bureau of Standards.*

As one of the most important questions likely to be considered by the St. Louis International Electrical Congress will be that of redefining the fundamental electrical units it may not be out of place at this time, to briefly review the efforts which have thus far been made to bring about international uniformity in this respect.

The need of a definite and universal system of electrical units was early recognized, and became a necessity as soon as industrial applications of electricity were made. At first the principal measurements were those of resistance (line resistance, insulation resistance, measurements for the location of faults, etc.). These were expressed in terms of some entirely arbitrary standard, such as the resistance of a given length of an iron or copper wire of given cross-section. This naturally led to a great multiplicity of units, none of which ever gained general acceptance.

In 1848 Jacobi pointed out that it would be more satisfactory to adopt as a universal standard the resistance of a certain piece of wire, copies having the same resistance being easily constructed. Jacobi carried this suggestion into practice by sending copies of his standard, since known as "Jacobi's Etalon", to the leading physicists of that period.

In 1860 Werner von Siemens proposed as a standard of resistance the resistance, at 0 deg. C., of a column of mercury of a uniform cross-section of 1 sq. mm and 1 m in length.

In 1861 a committee composed of the most eminent English physicists was appointed by the British Association to consider the question of standards of electrical resistance. The leading foreign physicists were invited to offer suggestions, and various special investigations of the problems with which the committee was confronted were undertaken by its members.

It was decided that the unit of resistance should be defined in terms of the Gauss-Weber absolute system of electromagnetic units,

which had already received such well-merited recognition; but since this unit was inconveniently small it was decided to define the practical unit as an integral decimal multiple of the same.

The value of the unit depends upon the units of length, mass and time adopted as the basis of the system. Those chosen by Gauss and Weber were the millimeter, milligram and second; while in England efforts were being made to establish an absolute system for the definition of all physical units, for which the fundamental units of Weber were of inconvenient magnitude, and for which the centimetre, gramme, and second were finally adopted (the c. g. s. system).

The practical unit of resistance in this system was defined as 10^9 c. g. s. electromagnetic units, and while this definition fixes the unit theoretically, it can only be applied in practice by the measurement of some particular resistance in absolute measure. This requires the construction of especially designed apparatus, with which measurements lying within a very limited range may be made; the determination of its instrumental constants most frequently involving tedious mathematical approximations, and the elimination of errors of observation. With all possible precautions the errors of such methods exceed, even today, a hundred-fold the relative errors in resistance comparisons.

Investigations were, therefore, made to determine whether the absolute unit of resistance could be accurately defined in terms of the resistance of a definite portion of a definite substance. The electrical properties of alloys and pure metals in the solid and liquid states, were studied with this end in view. On account of the excessive influence, on the resistance, of even small quantities of impurities in metals of the highest obtainable purity, and of small variations in the composition of alloys, the choice was greatly limited. It was found, in addition, that solid metals had to be rejected on account of the marked influence of physical changes produced by annealing, hardening, drawing, bending, etc.

Mercury, already recommended by Siemens, was, therefore, the only material to be further considered, but was also rejected for two reasons, viz., the large differences found to exist between coils supposedly adjusted to different German mercurial standards, and differences between a number of mercurial standards constructed by members of the committee.

The committee, therefore, recommended the alternative method of constructing material standards adjusted with reference to the

absolute unit. In this connection a special form of resistance standard known as the B. A. type was designed, and after an investigation of the constancy of a number of new alloys in addition to many already in use, one containing two parts by weight of silver to one part by weight of platinum was finally selected as best meeting all requirements.

In 1863 and 1864 the values of certain coils were determined in absolute units by one of the methods proposed by Weber, and from these measurements the "B. A." unit was derived. A number of copies were issued, gratis, by the Association, and in addition arrangements were made for supplying others at a moderate price. The B. A. unit soon gained general acceptance in the English speaking countries, while the Siemens unit still retained its supremacy on the Continent.

No action was at that time taken by the British Association committee to define the units of current and electromotive force further than in terms of the c. g. s. system. The currents to be measured were all relatively small, and were usually measured by means of a tangent galvanometer with a sufficient accuracy. Electromotive forces were seldom measured, and then usually in terms of the Daniell cell. In 1872 Latimer Clark brought to the attention of the committee the superiority of the cell which now bears his name, recommending it as a suitable standard of electromotive force, but no definite action was taken by the committee.

In 1878 it was shown by Professor H. A. Rowland that the B. A. unit was in error by more than 1 per cent, and soon after the existence of a discrepancy of this magnitude was verified by a number of other investigators.

In 1881 a call was issued by the French Government for an International Electrical Congress, to be held in connection with the first International Electrical Exposition at Paris, for the purpose of adopting definitions of the electrical units which might serve as a basis for legislative enactments. In the meantime a number of mercurial standards had been constructed and had been found to be in satisfactory agreement; moreover, the results of most of the absolute determinations had been referred either directly or indirectly to the Siemens unit.

The Paris Congress, therefore, recommended that the practical electrical units be defined in terms of the units of the c. g. s. system of electromagnetic units, and that the unit of resistance be represented by a column of mercury 1 sq. mm in cross-section, at the

temperature of 0 deg. C., of a length to be determined by an international commission appointed for this purpose, as appears in the following resolutions:—

RESOLUTIONS OF THE INTERNATIONAL CONGRESS OF ELECTRICIANS, PARIS, 1881.

- 1) That the c. g. s. system of electromagnetic units be adopted as the fundamental units.
- 2) That the practical units, the ohm and the volt, preserve their previous definitions, 10^9 and 10^8 c. g. s. units respectively.
- 3) That the unit of resistance, the ohm, be represented by a column of mercury 1 sq. mm in cross-section at the temperature of 0 deg. C.
- 4) That an international commission be charged with the determination, by new experiments, of the length of the mercury column 1 sq. mm in cross-section, at a temperature of 0 deg. C., representing the ohm.
- 5) That the current produced by a volt in the ohm be called an ampere.
- 6) That the quantity of electricity produced by a current of 1 ampere in one second be called a coulomb.
- 7) That the unit of capacity be called a farad, which is defined by the condition that a coulomb in a farad raises the potential 1 volt.

The Congress¹ also recommended the employment of the carcel as the standard for photometric comparisons.

The international commission appointed in accordance with paragraph 4 of the resolutions of the Paris Congress of 1881, met at Paris in 1882, but definite action was deferred until two years later, when the following definitions were unanimously recommended:—

The legal ohm is the resistance of a column of mercury 1 sq. mm in cross-section, and 106 cm in length, at the temperature of melting ice.

The ampere is equal to one-tenth of a c. g. s. unit of the electromagnetic system.

The volt is the electromotive force which will maintain a current of 1 ampere in a conductor of which the resistance is a legal ohm.

The value adopted for the length of the mercurial column was taken as 106 cm, notwithstanding that most of the best results were very close to 106.3 and it was thought advisable to adopt a value known to be true to the nearest centimeter for a period of 10 years. On account of this uncertainty, no steps were actually taken by the various governments represented.

The conference also adopted as the unit of light of any color the quantity of such light emitted in a perpendicular direction by 1 sq. cm of molten platinum at the temperature of solidification;

1. For the sake of completeness the recommendations of the various International Electrical Congresses on photometric standards are included in the summary.

and as the practical unit of white light the total quantity of light emitted perpendicularly by the same source.

In 1889 a second international congress of electricians was held at Paris, by which the following definitions were adopted:—

The joule, the practical unit of energy, is equal to 10^7 c. g. s. units. It is equal to the energy disengaged as heat in one second by a current of 1 ampere flowing through a resistance of 1 ohm.

The practical unit of power is the watt. The watt is equal to 10^7 c. g. s. units, and is the power of one Joule per second.

The practical unit of self-inductance is the quadrant, which is equal to 10^9 cms.

The Congress recommended that the power of machines be expressed in kilowatts instead of in horse-power.

It adopted also, as the photometric standard, the "bougie decimal," defined as one-twentieth of the Violle platinum standard adopted by the Conference of 1884.

The following definitions were also adopted:—

The period of an alternating current is the duration of a complete oscillation.

The frequency is the number of periods per second.

The mean intensity is defined as the mean value of the current during a complete period, without reference to its sign.

The effective intensity is the square root of its mean-squared value.

The effective electromotive force is the square root of its mean-squared value.

The apparent resistance is the factor by which the effective current must be multiplied to obtain the effective electromotive force.

The positive pole of a storage cell is that which is connected to the positive pole of a dynamo in charging, and which is the positive pole during its discharge.

In addition, the question of defining and naming practical magnetic units was discussed. The definition proposed for the unit of field intensity was the intensity of a uniform field which would produce an electromotive force of 1 volt in a conductor 1 cm in length normally cutting the lines of force with a velocity of 1 cm per second. The name proposed for this unit was the "Gauss;" and as the unit which is equal to 10^8 c. g. s. units does not correspond to field intensities ordinarily dealt with, the micro-Gauss was suggested for ordinary use.

The Weber, defined as 10^8 c. g. s. units, was proposed as the unit of magnetic flux.

No definite action was, however, taken by the Congress on either of these units.

The increased accuracy obtainable by the use of apparatus of improved construction, and by refinements in the methods em-

ployed, led to a much closer agreement of the various redeterminations of the absolute electrical units, and their relation to the Siemens unit, the Clark cell, and the electro-chemical equivalent of silver in terms of which many measurements were made. The rapid development of the electrical industries also called for a redefinition of the units, and the legalization of such definitions.

In December, 1890, a committee was appointed by the English Board of Trade to consider what action should be taken by the Board with a view to causing new denominations of standards for the measurements of electricity for use for trade to be made and duly verified. The members of this committee consisted of two representatives each of the Board of Trade, the General Post-Office, the Royal Society, the British Association, and the Institute of Electrical Engineers.

A set of resolutions embodying the proposals which appeared to be desirable were drafted, and copies of the same were submitted to the various interests for criticism. These resolutions also embodied proposals for standards of resistance, current, and electro-motive force.

In 1891 a committee was appointed by the American Institute of Electrical Engineers to report on units and standards. The report of the committee, made in June, 1891, which deals mainly with magnetic units, is as follows:—

Your committee, considering that authorized and recognized names for four practical electromagnetic units, at present unentitled, are needed by electrical engineers in this as well as in other countries, for dealing conveniently with magnetic circuits in analysis, discussion, and design, recommends to the Institute the four units as appended in detail, of magnetomotive force, reluctance, flux, and flux-density, in the hope that if favorably considered, the Institute may further the endeavors of the next International Electrical Congress toward securing for them universally recognized titles.

• • •
• • •

1st. *Magnetomotive Force*; or difference of magnetic potential.

Simple definition.—The analogue in a magnetic circuit of voltage in an electric circuit.

Strict definition.—The magnetomotive force in a magnetic circuit is four π multiplied by the flow of current linked with that circuit.

The magnetomotive force between two points connected by a line is the line integral of magnetic force along that line. Difference of magnetic potential constitutes magnetomotive force.

Electromagnetic dimensional formula, $L^{\frac{1}{2}}M^{\frac{1}{2}}T^{-1}$.

The absolute unit of m. m. f. is $\frac{1}{4\pi}$ x unit current of one turn.

The practical unit is $\frac{1}{4\pi}$ x ampere of one turn, or one-tenth of the absolute unit — i. e., 0.0796 ampere-turn gives the unit. The prefix kilo- would perhaps be occasionally used for practical applications.

2nd. *Magnetic Flux.*

Simple definition.— Total number of lines of force or total field.

Strict definition.— The magnetic flux through a surface bounded by a closed curve is the surface integral of magnetic induction taken over the bounded surface, and when produced by a current is also equal to the line integral of the vector potential of the current taken around the boundary.

The uniform and unit time rate of change in flux through a closed magnetic circuit establishes unit electromotive force in the circuit.

Electromagnetic dimensional formula, $L^{\frac{1}{2}}M^{\frac{1}{2}}T$.

The absolute unit is one c. g. s. line of induction.

The practical unit is 10^8 c. g. s. lines.

Fluxes range in present practical work from 100 to 100,000,000 c. g. s. lines, and the working units would perhaps prefix milli- and micro-.

3d. *Magnetic Intensity*, or induction density.

Simple definition.— Flux per sq. cm.

Strict definition.— The induction density at a point within an element of surface is the surface differential of the flux at that point.

Electromagnetic dimensional formula, $L^{\frac{1}{2}}M^{\frac{1}{2}}T^{-1}$.

Absolute unit, one c. g. s. line per sq. cm.

Practical unit, 10^8 c. g. s. lines per sq. cm.

In practice, excluding the earth's field, intensities range from 100 to 20,000 lines per sq. cm., and the working unit would perhaps have the prefix milli- or micro-.

4th. *Magnetic Reluctance.*

Definition.— Unit reluctance in a magnetic circuit permits unit magnetic flux to traverse it under the action of unit magnetomotive force.

Dimensional formula, $L^{-1}M^0T^0$.

The practical unit is 10^{-9} the absolute unit.

Reluctances vary in present practical work from 100,000 to 100,000,000 of these practical units, so that the working unit would perhaps employ the prefix mega-.

There were considerable differences of opinion manifested in the discussion following the presentation of the report, and definite action thereon was postponed.

At the Frankfort International Electrical Congress, in September, 1891, the question of naming and defining the magnetic units was brought up. The names Gauss and Weber, for field intensity and flux, respectively appeared to meet with general approval, but there was considerable disagreement as to what their numerical values should be, 10^8 being apparently preferred for both.

Owing to the limited time allowed for consideration, no definite action was taken.

In connection with the British Association meeting in Edinburgh in 1892, a conference was held, attended by Helmholtz, Guillaume, and others, to discuss the Board of Trade Report, which was submitted at the meeting. It was resolved to adopt for the length of the mercurial column 106.3 cms, and to express the mass of

the column of constant cross-section instead of the cross-sectional area of 1 sq. mm. Final action was deferred to await the decision of the Chicago International Electrical Congress, arrangements for which had then been made.

This Congress, to which the various governments were invited to send delegates, met in 1893. The governments represented were; United States; Great Britain; France; Italy; Germany; Mexico; Austria; Switzerland; Sweden; and British North America. Prof. von Helmholtz was made Honorary President of the Congress, and Prof. H. A. Rowland, President of the Chamber of Delegates. A Chamber of Delegates was organized composed of the official delegates of the various governments represented, by which the following resolutions were adopted after six days' deliberation:—

RESOLUTIONS OF THE INTERNATIONAL ELECTRICAL CONGRESS, CHICAGO, 1893.

Resolved, That the several governments represented by the delegates of this International Congress of Electricians be, and they are hereby, recommended to formally adopt as legal units of electrical measure the following:

Ohm. As a unit of resistance, the *international ohm*, which is based upon the ohm equal to 10^9 units of resistance of the c. g. s. system of electromagnetic units, and is represented by the resistance offered to an unvarying electric current by a column of mercury at the temperature of melting ice 14.4521 grammes in mass, of a constant cross-sectional area and of the length of 106.3 cms.

Ampere. As a unit of current, the *international ampere*, which is one-tenth of the unit of current of the c. g. s. system of electromagnetic units, and which is represented sufficiently well for practical use by the unvarying current which, when passed through a solution of nitrate of silver in water, and in accordance with accompanying specifications, deposits silver at the rate of 0.001118 of a gramme per second.

Volt. As a unit of electromotive force, the *international volt*, which is the electromotive force that, steadily applied to a conductor whose resistance is 1 international ohm, will produce a current of 1 international ampere, and which is represented sufficiently well for practical use by $\frac{1000}{1000}$ of the electromotive force between the poles or electrodes of the voltaic cell known as Clark's cell, at a temperature of 15 deg. C., and prepared in the manner described in the accompanying specifications.

Coulomb. As a unit of quantity, the *international coulomb*, which is the quantity of electricity transferred by a current of 1 international ampere in one second.

Farad. As a unit of capacity, the *international farad*, which is the capacity of a condenser charged to a potential of 1 international volt by 1 international coulomb of electricity.

Joule. As a unit of work, the *joule*, which is equal to 10^7 units of work in the c. g. s. system, and which is represented sufficiently well for practical use by the energy expended in one second by an international ampere in an international ohm.

Watt. As a unit of power, the *watt*, which is equal to 10^7 units of power in the c. g. s. system, and which is represented sufficiently well for practical use by work done at the rate of 1 joule per second.

Henry. As the unit of induction, the *henry*, which is the induction in a circuit when the electromotive force induced in this circuit is 1 international volt, while the inducing current varies at the rate of 1 ampere per second.

Specifications.

In the following specifications the term silver voltameter means the arrangement of apparatus by means of which an electric current is passed through a solution of nitrate of silver in water. The silver voltameter measures the total electrical quantity which has passed during the time of the experiment, and by noting this time the time average of the current, or if the current has been kept constant, the current itself can be deduced.

In employing the silver voltameter to measure currents of about 1 ampere, the following arrangements should be adopted:

The kathode on which the silver is to be deposited should take the form of a platinum bowl not less than 10 cms in diameter and from 4 to 5 cms in depth.

The anode should be a plate of pure silver some 30 sq. cms in area and 2 or 3 mms in thickness.

This is supported horizontally in the liquid near the top of the solution by a platinum wire passed through holes in the plate at opposite corners. To prevent the disintegrated silver which is formed on the anode from falling on to the kathode, the anode should be wrapped round with pure filter paper, secured at the back with sealing wax.

The liquid should consist of a neutral solution of pure silver nitrate, containing about 15 parts by weight of the nitrate to 85 parts of water.

The resistance of the voltameter changes somewhat as the current passes. To prevent these changes having too great an effect on the current, some resistance besides that of the voltameter should be inserted in the circuit. The total metallic resistance of the circuit should not be less than 10 ohms.

SPECIFICATIONS FOR THE CLARK CELL.

A committee, consisting of Messrs. Helmholtz, Ayrton, and Carhart, was appointed to prepare specifications for the Clark's cell. Owing to the death of von Helmholtz no report was ever made by this committee.

MAGNETIC UNITS.

A motion was made and carried that for magnetic units the c. g. s. system be commended, and that for the present no names be given to these units.

PHOTOMETRIC STANDARDS.

A resolution was adopted as follows:

Resolved, That this committee while recognizing the great progress realized in the standard lamp of von Hefner-Alteneck, and the very important researches made at the Reichsanstalt, also recognizes that other standards have been proposed and are now being tried, and that there are serious objections to every kind of standard, in which an open flame is employed. It is, therefore, unable to recommend the adoption at the present time of either the von Hefner lamp or the pentane lamp, but recommends that all nations be invited to make researches in common on well-defined practical standards, and on the convenient realization of the absolute unit.

In March, 1900, the following resolution was adopted by the American Institute of Electrical Engineers:—

Moved, That the committee on units and standards be requested to investigate and report at the ensuing meeting in regard to the advisability of the following:

1. The giving of names to the absolute units of the electrostatic and electromagnetic systems.
2. The denotations, by means of prefixes, of multiples of such units
3. The rationalization of the present system by means of taking the absolute unit of magnetism as equal to the present magnetic line, and the absolute unit of difference of magnetic potential as equal to the present absolute unit of current-turn.
4. The advisability of taking up any or all of the above matters at the Congress to be held in Paris this year.

In May, 1900, the following report of the committee was adopted by the Institute:—

1. We consider that there is need for names for the absolute c. g. s. units in the electrostatic and the electromagnetic systems; also for suitable prefixes to denote decimal multiples and submultiples of these units, in supplement and addition to those already in common use.
2. That the International Electrical Congress convening this year at Paris should be urged to bestow the above-mentioned names and create said decimal prefixes.
3. That much advantage would accrue to a universal "rationalization" of electric and magnetic units, and that the Congress be requested to consider the means and advisability of such "rationalization."
4. That we recommend that the whole subject should be brought up as a topic for general discussion at the approaching general meeting of the Institute in Philadelphia.

(Signed) F. B. CROCKER
 W. E. GEYER
 G. A. HAMILTON
 W. D. WEAVER
 A. E. KENNELLY, *Chairman.*

PARIS CONGRESS, 1900.

The last official Congress was held at Paris in August, 1900.

A committee of Section 1 to consider questions in reference to the units reported as follows:—

The committee will only take into consideration propositions not involving modifications of the decisions of previous congresses.

The committee believes that there is no actual need of giving names to all the electromagnetic units.

However, owing to the employment, in practice, of apparatus giving directly field intensities in c. g. s. units, the committee recommends giving the name "Gauss" to this c. g. s. unit.

The committee recommends giving to the unit of magnetic flux, the value of which is subsequently to be fixed, the name "Maxwell."

The report adopted by the Section, after a spirited discussion, was as follows:—

1. The Section recommends giving the name "Gauss" to the c. g. s. unit of magnetic field intensity.
2. The Section recommends giving the name "Maxwell" to the c. g. s. unit of magnetic flux.

These units were given an international character and standing by their adoption at the general meeting of the official delegates of the various governments, after a stormy debate.

PART II.

THE LEGALIZATION OF THE ELECTRICAL UNITS BY THE VARIOUS GOVERNMENTS.¹

Notwithstanding that the resolutions of the Chicago Congress were adopted with practical unanimity, and might, therefore, have been considered as in a sense binding on the various governments, up to this date only six governments, United States, Great Britain, Canada, Germany, Austria, and France have legislated on this subject, and only a few of these have acted strictly in accordance with the resolution of the Chicago Congress.

DISCUSSION OF LEGISLATION.

Strictly speaking, no two countries have defined the electrical units in the same way. This naturally suggests that there must be good and sufficient reasons, which may in part be traced to the insufficiency of the Chicago definitions.

1) It is evident that all three of the units should not be defined in terms of concrete standards, connected as they are by Ohm's law so that only two of the three are independent, and hence the third should be defined in terms of the other two.

2) The two units adopted as fundamental should be defined only in terms of concrete standards, and not in terms of the absolute units.

3) The specifications for the silver voltameter were shown to be inadequate.

4) Redeterminations of the electromotive force of the Clark cell at 15 deg. C. in absolute measure indicated that this value was nearer 1.433 volts than 1.434 volts.

However, the variations introduced in the definitions by some of the governments lead to confusion and are in violation of the principles laid down at the Chicago Congress.

THE UNIT OF RESISTANCE.

Taking the fundamental units up in turn, it will be found that the unit of resistance legalized by the United States, Germany,

1. For copies of the laws, see Bulletin No. 1, Bureau of Standards.

France and Canada, and the definitions in the proposed Belgian and Swiss laws, are essentially the same as those adopted at Chicago, differing only in that no reference is made to the unit of resistance being based on 10^9 c. g. s. units in case of the German and French laws, and in the proposed Swiss and Belgian laws. In fact, it must be admitted that this statement may be regarded as superfluous.

Austria. In Austria, on the other hand, the unit of resistance is defined as 10^9 c. g. s. units of the electromagnetic system, which "for practical purposes is to be considered equal to the resistance offered at the temperature of melting ice by a column of mercury 106.3 cms in length and having a mass of 14.4521 grammes." The uniformity of cross-section is, curiously, not specified.

England. In England, finally, the ohm is defined both as *having the value* of 10^9 in terms of the centimeter and the second of time, and as *being represented* by "the resistance offered to an unvarying electric current by a column of mercury at the temperature of melting ice 14.4521 grammes in mass of a constant cross-sectional area and of a length of 106.3 cms". In addition, a distinction is made between the *unit* of resistance and the *standard* of resistance, and for the latter purpose a particular platinum-silver coil preserved at the Board of Trade Electrical Standardizing Laboratory, in London, and adjusted to represent the unit on an assumed relation between the standards of the British Association and the mercurial unit, is legalized.

It will thus be seen that the unit of resistance has been defined:

- 1) In terms of the absolute c. g. s. unit.
- 2) In terms of the mercurial column.
- 3) In terms of the resistance of a particular coil.
- 4) In terms of combinations of the above.

The objections to the first method have been recognized as long as the subject has been under discussion. For, while the unit is theoretically fixed, resort must in practice be had to material standards, in the absolute measurement of which, errors amounting to at least 0.01 per cent are introduced. Errors several times as great are even met with in different series of observations with the same apparatus, and the difference of the results obtained by different methods may differ still more.

To overcome this objection a suggestion was made in 1893 by Professors W. E. Ayrton, and A. V. Jones, that the unit of resistance be defined in terms of a particular Lorenz apparatus pre-

served in a National Physical Laboratory,— but even then an uncertainty of at least 0.01 per cent would remain, if this practice were adopted by a single government, whereas its general introduction would certainly introduce greater differences.

Another objection to this method lies in the limited range within which accurate measurements of resistance may be made with a given apparatus, so that in practice the measurements would have to be referred to material standards the constancy of which might from time to time be checked to within the above stated limit of accuracy.

Notwithstanding these objections we find that a number of governments have defined the unit of resistance in terms of the absolute unit, indicating that the above principles are not fully appreciated.

The accuracy with which resistance comparisons can be made has for a long time far exceeded the above limits, and the need of an accurate standard, reproducible at any time and at any place to a higher degree of accuracy, has been recognized, as this would enable measurements the world over to be expressed in terms of the *same unit*,— a result of much greater importance than in absolute measure, with its limited accuracy. In the definition of the concrete standard it is only necessary to assume for it a value in accordance with the best absolute measurements. This once done with a sufficient approximation, the definition of the concrete standard need not be modified.

The meter was originally intended to represent the one-ten-millionths part of the earth's quadrant; but in the actual construction errors of measurement were introduced, which will, however, not affect the *international* meter defined in terms of a particular platinum-iridium bar, of which accurate copies exist the world over, and to which all linear measurements are referred. In a similar manner, the kilogram was intended to represent the mass of a cubic decimeter of water at the temperature of its maximum density; but the *international* kilogram is the mass of a particular cylinder of platinum-iridium, to which all measurements of mass are referred.

It has, therefore, been generally recognized that *reproducibility* should be the first requirement for any international standard, and this qualification is fulfilled to an eminent degree by the mercurial unit, as defined by the Chicago Congress.

When this definition was adopted it was generally assumed that

such mercurial standards would be constructed by the various governments represented; but this has been done by only two,—Germany and England,—each of which is provided with an institution equipped to undertake this task. The construction of primary mercurial standards is also to be undertaken by the Bureau of Standards, more recently organized, and no doubt by other institutions.

The mercurial standards at the Reichsanstalt agree with one another to within a few parts in 100,000, as do those of the English National Physical Laboratory; and it is, in addition, most gratifying to know that the standards of the two institutions agree with each other almost equally well.

There is, however, one criticism which might still be made of the definition of the unit of resistance in terms of the mercurial unit. Some form of terminal must be applied to the tube to connect it to the circuit containing the resistance standard with which it is to be compared. The method used at the Reichsanstalt consists in employing spherical bulbs, each provided with a current and potential lead, which necessitates the application of a correction, the value of which can be calculated approximately as Lord Rayleigh has shown or may be experimentally determined. Unfortunately, the value experimentally found is less than the minimum limit according to Lord Rayleigh's calculations, so that a different result would be obtained according to the correction factor employed.

In addition, there is another method which might, and has been used, of applying potential terminals to the extremities of the tube, which is provided with prolongations previously continuous with the same. This method also introduces a correction the value of which would depend upon a number of conditions.

In any case, however, this source of uncertainty, although slight, could be eliminated by specifying the approximate cross-section or length of the tube representing the unit, the nature of the terminals, and the magnitude of the correction factor to be applied.

THE UNIT OF CURRENT.

The Chicago definition of the ampere as one-tenth of the c. g. s. unit has been followed almost verbatim by the United States, Canada, France and Austria, and the specifications for the silver voltameter are essentially the same except in Austria, where no specifications have been legalized.

In Germany the ampere is simply defined in terms of the electrochemical equivalent of silver, and in addition the specifications for the silver voltameter are considerably modified.

The proposed Swiss law has been copied from the law adopted by Germany.

The Belgian law differs from the German law only in that the ampere is defined, not as being equal to, but as being sufficiently well represented for practical purposes by "the intensity of a constant current which precipitates in one second 0.001118 grammes of silver from an aqueous solution of silver nitrate."

In England it is defined both as one-tenth of a c. g. s. unit, and as being represented by "the unvarying electric current which when passed through a solution of nitrate of silver in water in accordance with the specification appended hereto and marked *A*, deposits silver at the rate of 0.001118 of a gramme per second." In addition, a distinction is made between the *unit* of current and the *standard* of current, the latter being defined in terms of a particular standard ampere balance preserved in the Board of Trade Electrical Standardizing Laboratory.

It will thus be seen that the ampere is defined in three distinct ways, and in some cases the same country has defined it in two or more ways. As has been pointed out, if the ampere is selected as the second fundamental unit it should not be defined in terms of the absolute unit, but simply in terms of the silver voltameter, for which, according to a number of investigations since 1893, the specifications are quite insufficient, as differences amounting to more than 0.1 per cent may be obtained. The cause of these variations was first shown by Kable at the Reichsanstalt to be due to secondary reactions in the voltameter, as indicated by differences when freshly prepared silver nitrate solutions and solutions previously used are employed. Richards, Collins and Heimrod have traced this influence to the secondary reactions at the anode, and have shown that they may be reduced and possibly eliminated by surrounding the same with a porous cup in which the solution is always kept at a lower level than outside, to prevent diffusion.

This subject has been further investigated by Dr. K. E. Guthe, of the Bureau of Standards, who confirmed the results of Richards, Collins and Heimrod and who showed, in addition, that the secondary reactions at the anode are further decreased by the use of a large anode, the best results being obtained with a silver plate in contact with granulated silver. Variations in the results have been

attributed by Leduc to the filter paper, with which in the older forms the anode is surrounded. That the silver nitrate acts upon the paper cannot be questioned, but its influence on the solution can hardly explain the results.

The filter paper, however, fails to prevent the secondary products formed at the anode, the exact nature of which has not been established, from reaching the cathode, while the porous cup prevents it almost entirely. The results obtainable with the Richards and the modified forms seem to be reproducible to within about one part in 20,000, so that unit current may be defined in terms of the electro-chemical equivalent of silver to within this order of accuracy.

The two arguments most frequently advanced in favor of concretely defining the ampere, instead of the volt, are as follows:—

1) According to Faraday's laws of electrolysis, the amount of a given metal deposited in a given time by a given current is constant; but, while Faraday's laws may be fundamental laws of nature, as seen above, complications are introduced by secondary reactions at the electrodes, which vary with the metal and the current density employed. Constant results are, however, obtainable by specifying the form and manner of employment of the voltameter, at least in the case of the silver voltameter.

2) Current intensity can be determined in absolute measure directly by the electro-dynamometer, while electromotive force can only be measured directly in absolute units of the electrostatic system, and the accuracy with which the results can be reduced to electromagnetic units depends upon the accuracy with which " v ," the ratio of the units of the two systems or the velocity of light is known, and this is uncertain by possibly as much as one part in one thousand.

While this argument would have considerable weight if the fundamental units were to be defined in terms of their absolute values, a practice which, as pointed out above, should be abandoned entirely, it has little bearing on the definition of either current or electromotive force in terms of a concrete standard, for which a value may be adopted which agrees with the best results of absolute current measurement.

The objections which might be urged against defining the ampere, instead of the volt, are as follows:—

1) With a given silver voltameter the range is limited, and only currents lying within certain narrow limits can be accurately measured.

2) Enough time must be allowed for the deposit of at least several grammes of silver, so that accurate weighings may be made.

3) The duration of the experiment must be at least one-half hour, in order that the time may be accurately measured.

4) During the experiment the current must be kept constant by continuous regulation, or the variations from its mean value must be determined at frequent intervals, so that the average value may be calculated.

5) Tedious double weighings must be made to determine the amount of silver deposited.

6) The result finally obtained applies to the average value of the current employed during the experiment, and cannot be utilized for the accurate measurement of other currents except by reference to a standard cell and a standard resistance, or to some form of apparatus for current measurement, such as the electro-dynamometer, in which case the accuracy is not as great as that obtained by direct reference to a standard cell.

UNIT OF ELECTROMOTIVE FORCE.

The definition of the volt adopted at Chicago has been legalized almost verbatim by the United States, Canada and France. In Germany and Austria it is defined simply in terms of the ohm and ampere, as is also the case in the proposed Swiss and Belgian laws.

In England the volt is defined as 10^8 c. g. s. units, in terms of the ohm and ampere, and in terms of the Clark cell. In addition, a distinction is made between the *unit* of electromotive force and the *standard* of electromotive force, the latter being defined as the $1/100$ part of the pressure producing a certain deflection of a Kelvin electrostatic voltmeter of the multicellular type preserved at the Electrical Standardizing Laboratory of the Board of Trade.

Here again the definitions legalized differ considerably. Of the various definitions only two need be considered,—that in terms of the ohm and ampere, if these units are taken as fundamental, and the definition in terms of the standard cell, if the ohm and volt are taken as the fundamental units.

The arguments in favor of the latter alternative may be briefly summarized as follows:—

1) The facility with which any voltage may be directly measured in terms of the standard cell by the potentiometer.

2) The accuracy with which such measurements may be made, which is practically limited only by the accuracy with which resistance is measurable and by the reproducibility of the cell.

3) The accuracy with which the standard cell can be reproduced, which even today exceeds all practical requirements and which may be still further increased by specifying more precisely the manner of purification and preparation of the materials employed, etc.

4) The resulting definition of the ampere in terms of the ohm and volt, which corresponds to the actual method employed in precision measurements of current intensity by the potentiometer method.

5) The facility and accuracy with which any current may be thus measured.

These considerations have led to the adoption of the Clark cell in Germany as the practical standard of electromotive force, notwithstanding that the ampere is legally defined in that country in terms of the electro-chemical equivalent of silver and the volt in terms of the ohm and ampere.

For the electromotive force of the Clark cell, the value 1.4328 was adopted in Germany as equivalent to the legalized definitions of the ohm and ampere.

In the United States the legalized value of the electromotive force of the Clark cell is 1.434 volts at 15 deg. C. Either this value had to be taken or that of the electrochemical equivalent of silver. The latter was out of the question owing to the insufficiency of the legalized specifications for the silver voltameter and the large variations reported.

The specifications for the Clark cell legalized in the United States were drawn up by the National Academy of Sciences, and refer to the χ type; while those in England, Canada and France are essentially those drawn up by the Board of Trade committee and refer to the Board of Trade type.

STANDARD CELLS.

Of the standard cells proposed, only the Clark and Weston cells are to be considered at present. In the former the electrodes consist of zinc amalgam covered with a layer of zinc sulphate crystals, and pure mercury in contact with a paste of mercurous sulphate, zinc sulphate crystals and metallic mercury, the electrolyte being a saturated aqueous solution of zinc sulphate and mercurous sulphate.

In the Weston cell the electrodes consist of cadmium amalgam covered with a layer of cadmium sulphate crystals, and pure mercury in contact with a paste of mercurous sulphate, cadmium sulphate crystals, and metallic mercury, the electrolyte being a concentrated aqueous solution of cadmium sulphate and mercurous sulphate.

The investigations thus far reported indicate that differences between individual cells of either type, set up from materials obtained from various sources and at various times, agree with each other to within 0.0002 volts, corresponding to a slight advantage in favor of the Clark cell on account of its higher electromotive force. The constancy and reproducibility of both types have also been established by the constancy of the ratio between them.

While sharing with the Clark cell these most essential qualities, the Weston cell has a number of marked advantages.

1) The higher temperature coefficient of the Clark cell is a serious obstacle to measurements of the highest precision, while that of the Weston cell at ordinary temperatures is less than one-twentieth as great, so that errors due to temperature uncertainties are correspondingly reduced.

2) Clark cells are subject, particularly when a number of years old, to large hysteresis effects attending temperature variations. In the Weston cell the error due to this cause can only amount to a small fraction of that in the Clark cell, owing to the relatively slight influence of temperature on the solubility of the cadmium sulphate.

3) The average life of Clark cells is quite short, owing to the tendency of the cell to crack at the point where the platinum terminal is fused into the amalgam limb. This objection might be obviated by suitable modifications in the construction, as have been suggested, but not without introducing some complication. No such tendency has been observed with Weston cells.

4) In Clark cells a layer of gas is formed at the amalgam surface, even when carefully neutralized solutions are employed, which may interrupt the circuit, thus rendering the cell useless. In the Weston cell no gas is, apparently, formed.

Owing to these marked advantages, the Weston cell is certain to displace the Clark cell in the laboratory, and no doubt many advocates of the adoption of the former as the standard of electromotive force will be found among the delegates to the St. Louis International Congress.

SPECIFICATIONS FOR THE STANDARD CELL.

If either the Clark or the Weston cell be adopted as the standard of electromotive force, the specifications will have to be to some extent redrawn if the highest accuracy of reproduction is sought, as the differences between individual cells set up with different materials at present far exceed the relative errors made in current and electromotive force measurements by the potentiometer method. It, therefore, seems desirable, as stated above, to specify more precisely the methods of purification and preparation of the materials employed.

Fortunately, the metals entering into the composition of Clark and Weston cells,—mercury, zinc and cadmium,—are among the few which can be obtained by special methods so pure that the foreign metals in them do not exceed more than 0.001 per cent. Zinc sulphate and cadmium sulphate can be obtained from the specially purified metals and pure sulphuric acid. Even considerable quantities of the impurities usually accompanying the above materials, when purchased as “chemically pure,” exert a relatively small and even insignificant influence on the electromotive force of the cell. In defining the standard cell, however, the method of preparation or purification, and the degree of purity of the materials, should certainly be specified.

The principal source of variation of the standard cell has lately been shown to be due to differences in the electromotive properties of the mercurous sulphate. The “chemically pure” mercurous sulphate of commerce contains, besides nitrates, etc., basic mercurous sulphate, mercuric sulphate, basic mercuric sulphate, and possibly sulphites. According to the Chicago specifications, since generally adopted, the mercurous sulphate is washed a number of times with distilled water, which converts the mercuric sulphate into basic mercuric sulphate, which is not removed. Moreover, the water hydrolyzes the mercurous sulphate, converting part of it into basic mercurous sulphate. Both these materials having a definite solubility in the zinc sulphate and cadmium sulphate solutions, must exert an influence on the electromotive force of the cell. The basic mercurous sulphate, when present in excess, will exert an influence on the electromotive force, while the basic mercuric sulphate is gradually decomposed and eliminated, thus introducing a variable factor.

Pure mercurous sulphate, however, may be obtained from pure mercury and sulphuric acid, by an electrolytic method inde-

pendently devised by Carhart and Hulett, and the author, and the results already obtained indicate that the agreement of cells set up with this material is within a few parts in 100,000.

It is, therefore, most important, if the unit of electromotive force is defined in terms of the standard cell, to specify the manner in which this material is to be prepared, and to modify some of the specifications relating to its treatment.

Besides new specifications for the ampere or volt in terms of the electro-chemical equivalent of silver, or the electromotive force of some particular standard cell, respectively, it will be necessary to adopt a new value for one of these constants. This may be based either on the absolute determinations already made, applying to the accepted values corrections determined by the modifications in the specifications which may be adopted and a correction in order to bring the unit into closer agreement with the absolute value upon which it is based, or by new absolute determinations. If the latter alternative is decided upon considerable delay would probably ensue, and in addition not much could be gained, owing to the relatively large errors of all absolute measurements and the differences likely to be found between the results obtained by different investigators using different methods and apparatus.

Two determinations of the electromotive force, of the Clark cell in absolute measure, made by Kahle, at the Reichsanstalt, and by Carhart and Guthe, indicate that the value adopted by the Chicago Congress, 1.434 volts, is too large by about 1 millivolt; and in addition, several redeterminations of the mechanical equivalent of heat in electrical units give values for the latter which can only be brought into accord with the values determined by the direct mechanical methods if the electromotive force of the Clark cell be taken as 1.433. If this value be adopted for the Clark cell or the equivalent value for the Weston cell, the international units would be defined with a quite sufficient absolute accuracy, as the above value is most probably known to at least one part in 2000, and as at the present time a much higher absolute accuracy can hardly be predicted. It seems, on the other hand, that the main question is to define the international units with the prime object of *reproducibility* to the highest order of accuracy, and it is hoped that in this an accuracy of a few parts in 100,000 will be realized.

DERIVED UNITS.

It will be generally agreed that units of capacity, inductance, power, energy, and any others that the St. Louis Congress may decide to include, should be defined in terms of the definitions adopted for the fundamental units.

The joule and watt have, however, been defined in terms of the c. g. s. units by some countries, and objections will probably be raised to defining them in terms of the electrical units. Such objections could be met by making a distinction between the absolute joule and international joule, and the absolute watt and the international watt,—a distinction already used to some extent in distinguishing between the absolute units and the international electrical units. As the system becomes established the designation international will gradually be dropped. Moreover, if the values adopted for the international units agree with the absolute values upon which they are based to within even one part in 1000, as will be the case, the objections will be mainly theoretical, as all practical requirements will be met.

MAGNETIC UNITS.

The only official action thus far taken in defining the magnetic units is that of the Paris Congress of 1900, by which the c. g. s. units of magnetic field intensity and magnetic flux were adopted, the names Gauss and Maxwell being assigned to them.

The St. Louis Congress may, however, consider the adoption of additional units of magnetomotive force and magnetic reluctance and the definition of all the magnetic units in harmony with the practical system of electromagnetic units. None of the units, either of the practical or c. g. s. system, is of a convenient magnitude, but this should, of course, not determine the choice. If there is any need of decimal multiples or sub-multiples, these can be supplied by the use of a suitable prefix.

It must, however, be emphasized that the definition of the magnetic units directly in terms of the c. g. s. units or in terms of multiples or sub-multiples of the same is open to the serious objection that it would lead to an inconsistency if the fundamental electrical units are defined in terms of concrete standards, and that it would be equivalent to a redefinition of these electrical units, interconnected as they are with the magnetic units, in terms of the units of the c. g. s. system.

This can only be avoided by defining the magnetic units in terms of the fundamental international electrical units—the ohm, volt and ampere—and any resulting ambiguity might be removed by designating the units thus defined as international magnetic units.

DISCUSSION.

DOCTOR GLAZEBOOK: I ask to be permitted to speak, though I confess I find it a somewhat difficult task, because the subject is large and important, and at the same time the proposition before us is somewhat vague in character, and necessarily indefinite.

By way of preamble, I think I ought to state to the Congress that while I am here in the honorable position of a delegate from Great Britain, I and my colleagues are only authorized to adhere to any decision the Congress may come to personally, and such decision is not, of course, binding on His Majesty's Government, but must be referred to the proper authorities in England for their consideration and decision.

To turn, however, to the subject definitely before us, that of electrical units, I take it that in Professor Wolff's able paper there are two main points which he has opened for discussion. One of these is the question whether, either now or at some future date, the Clark cell is to be replaced by the Weston cell; and the other is perhaps the larger and more important question as to whether, in our fundamental definitions, we ought to replace the definition of the ampere by a definition of the volt, because, as it has been pointed out to us several times this morning, the three, the ohm, the ampere and the volt, are connected together, and it is important that, at any rate within practical limits, the three definitions should be consistent definitions.

Now, I think some slight difficulty has arisen as a consequence of the form of definition adopted by the Board of Trade in England, and perhaps I may clear the ground a little if I explain the position with regard to these three definitions. I think it was felt, when they were settled, that it was of great importance to adhere to the C. G. S. system of units, and therefore that the definitions adopted should be distinctly based on the C. G. S. system. So, turning to the legal definitions in Great Britain, the preamble of the order in council recites the C. G. S. definitions of the ohm, the ampere and the volt as the fundamental definitions upon which the standards to be used are to be based. Then it was quite clear from the discussion which had taken place at Edinburgh a year previously, when we had the great advantage of the presence of Doctor von Helmholtz, and representatives, as well, of this country—it was clear that we must introduce in some way into the definitions the mercurial resistance, the ampere as measured by the silver deposited, and some form of standard cell, but at the same time we were informed by the legal advisory authorities that it was necessary to have concrete standards to represent each of these quantities defined.

Therefore, although the mercurial resistance, and the electrochemical equivalent of silver, and the Clark cell, are referred to in the preamble

of the law, the schedule, which is the effective portion of the law, reads, "Now, therefore, Her Majesty, by virtue of the power vested in Her by the said act, by and with the advice of Her Privy Council, is pleased to approve the several denominations of standards set forth in the schedule hereto as new denominations of standards for electrical measurement."

These, then, are the legal standards for England, and those are: (1) a wire coil of platinum silver, which was measured by myself, and which has since been preserved at the Board of Trade; (2) a certain standard ampere balance, which was constructed under the supervision of the committee advising the Board of Trade, and was calibrated not by any absolute measurement, but by comparison with the ampere, as given by the electrochemical equivalent of silver, and (3) since we were told there must be concrete standards for all the units, the third standard is a voltmeter of special type devised and constructed under Lord Kelvin's personal supervision. This will perhaps explain how it is that while very often the units depending on the mercury resistance, the electrochemical equivalent of silver, and the Clark cell are referred to as English units, still, strictly, the standards recognized by law are those three instruments which now exist and have been carefully preserved by our Board of Trade.

Turning now to the proposals. The first one is, I take it, a proposal of some kind to substitute the Weston cell for the Clark cell. I think no one who has worked at the subject will differ from me when I express the opinion that for practical purposes, the Weston cell is superior to the Clark cell. I don't know that I agree entirely with all that Doctor Wolff has said, but in the main I agree with what he has said, and should accept that position. At the same time, it is a very serious matter to change a unit which is more or less legalized in a number of countries, and I feel that I should have considerable difficulty in going to our authorities in England and asking for this change, unless I could speak very positively indeed as to the value to be assigned to the e.m.f. of the Weston cell, and as to the advantages that would follow from the adoption of the cell, and further as to the exact specification to be adopted for making the cell. It is clear, I think, that the specifications which were adopted by the Board of Trade, and which were followed here in this country after the Chicago Congress with some modifications, as to the construction of the Clark cell, are at fault. Doctor Wolff has indicated that this is so, and Professor Carhart, I believe, agrees with him. At the same time, I am not clear that either Doctor Wolff or Professor Carhart would be prepared at the present moment to draw up specifications for a Weston cell which either would look upon as completely satisfactory. I think they could do it in no very long time.

In my own laboratory for some months past a series of experiments have been made on the various defects, or causes of defect, that arise in the Weston cell, or in the Clark cell, and in the main we have arrived at the same results as those obtained by Professor Carhart. It ought, I think, to be pointed out that Lord Rayleigh in one of his early papers referred to the mercurous sulphate as being the chief source of error in the cell. I don't think that has been sufficiently recognized either in papers prepared in England or elsewhere lately. I think it will be found

that is the case, and for this reason it seemed desirable to attempt in the first place to obtain a proper mercurous sulphate. I am glad to say (I am not going into details) that Mr. F. E. Smith has succeeded in my laboratory in getting a mercurous sulphate which gives us, if not absolutely, at least to within a few millionths of a volt, consistent values, by three distinct methods. It seems to me to be important that we should make the sulphate not merely by one method and get consistent results, but that we should vary our methods. One method is the method of fuming sulphuric acid; another is that referred to by Professor Carhart and Doctor Wolff. The third method is described in a paper here at the disposal of any gentleman especially interested. I think that we may claim that the rôle of the mercurous sulphate is satisfactorily established, and difficulties arising from it have been satisfactorily overcome. I may say, that cells prepared by these methods agree to within a few millionths of a volt. I have a table of values here, showing the e.m.f.s. of some of the cells; in the first case within three minutes of being put together, then when they were half an hour old, and then after some hours, and they only differ by quite trifling amounts.

But this result has shown us something else of importance. We have in the laboratory a considerable series of cells put up some three years ago with mercurous sulphate, as carefully prepared as we know how to prepare them, and as far as our tests go, the e.m.f.s. of these cells have remained practically constant since that date. They agree extraordinarily well with some of the well-known standards, but they differ appreciably from the e.m.f.s. of cells put up by the new method of preparing sulphate. Now that is a point that perhaps needs some further investigation. It occurred to me yesterday that something of that kind might easily explain some of the discrepancies pointed out by Professor Barnes in his paper.

Then, again, what is the e.m.f. of the Weston cell? Doctor Carhart has described to us his method of determining its value. I am afraid I failed to catch his last words. Has he completed the work, and is he prepared to give the value? I gather that he is not. With regard to the method I should say that I feel a little doubtful as to whether the electro-dynamometer method, depending on the torsion of a wire, and involving, as the formula shows, the square of the radius of the small coil, is as likely to give us as accurate a result as the method described by Lord Rayleigh in which only the ratio of the radius of the small coil to that of the large coil comes into consideration. However, be that as it may, an apparatus designed by Professors Ayrton and Jones is now in course of construction in my own laboratory. It has not proceeded very far, and it is rash to prophesy, but Professor Ayrton hopes in a few months to be able to give to the world the results of the observations made with that instrument. By that time I should suppose we might have come to some agreement as to the absolute value of the e.m.f. of a cell, and as to the specification for putting up the same, not merely with regard to the mercurous sulphate, but also in regard to the other ingredients, which exercise a certain small influence which is now being investigated in my own laboratory and elsewhere. Therefore, I shall not advocate the Congress coming to any resolution at the present moment in favor of actually now making

a change, though I shall be quite prepared to support a proposal at the proper time, when these factors are better known.

I have the honor to represent here the Institution of Electrical Engineers, among other English institutions, and also the Electrical Standards Committee of the British Association, which took these various matters into careful consideration at their last meeting, and the resolution which was then passed I will now read to the Congress:

"The committee is not prepared at present to displace the Clark cell, and prefers to wait for the conclusion of the experiments at the National Physical Laboratory, and with the new balance, before coming to a decision as to the value to be assigned to the e.m.f. of the cadmium cell. With regard to the choice of magnetic units the committee is of the opinion that the only two systems which need to be considered are the C. G. S. system and the Ampere-Volt-Ohm system, and that the quantities to be named, if any, are (1) magnetic potential, (2) magnetic flux, (3) magnetic reluctance. Of the above two alternatives, the committee is in favor of the C. G. S. system as that on which to base any nomenclature of magnetic units, but is of the opinion that a system of nomenclature is not called for."

So much for the first question. Now as to the question as to whether the Clark cell is to be replaced by the Weston cell. This other question appears to me to be one of greater difficulty. I think Colonel Crompton, who is with us, is to be congratulated on the general acceptance of the method he has established, and which he has pressed in season and out of season, for so many years. But I am not clear that it follows that we ought to make the definition of the volt rather than that of the ampere the second fundamental definition. I should like to go back, for these fundamental definitions, to simple facts as far as possible, and it seems to me that the fact, which I take to be one, that the chemical changes which go on in the silver voltameter are simpler and more readily understood, and I think more easily controlled than those which go on in the cell, might, at any rate, make us hesitate before we accept the proposal to replace the silver voltameter by the cell as our fundamental definition. I am confirmed in this contention, because I understand from some correspondence which I have had with President Kohlrausch as to the German legalized standards, and I should add from a paper recently published by the Reichsanstalt, that the German authorities adhere to the belief that the ampere as defined by the electrochemical equivalent of silver, should be retained as a second fundamental definition. I gather also from what I know of Professor Mascart's views that he thinks likewise.

I do not see the practical advantages which would follow from the change, and I do not think it is so important as to make it desirable for us to support it, or to urge it, at any rate at the present juncture.

I hope I have made clear to the Congress my own views as to this very important proposition, and I trust I may be allowed to express my thanks to Doctor Wolff for the extremely interesting and valuable paper which he has laid before the Congress, and to Professor Carhart for what he has

done at the Congress and previous to it, to enlighten and clear up the points before us for discussion.

DR. A. G. WEBSTER: I should like to support and express my hearty agreement with all that Doctor Glazebrook has said from the practical point of view, to which he has exclusively confined himself, and lest his remarks should be supposed to be tinctured with English conservatism, I should like to make, from my own point of view, a few remarks from a practical standpoint. This is a practical country. The question is, when we have adopted the changes suggested what good do we get from them? Now these laws of the different countries, as Doctor Wolff has shown us, differ somewhat. How much do they differ? Practically less, probably, than one part in one thousand. Now I am very sure that I do no insult to any electrical engineer here present, when I say that very few engineering measurements of any sort are at all influenced by an amount of one part in a thousand. Another thing. The next point. Suppose that the laws are to be changed. We are to have a certain cell, and a certain piece of mercury and a certain amount of silver deposit, or else we are to have three standard instruments, as have been adopted in Great Britain. It seems to me that we could not use these instruments universally, however good they might be. We may make laws specifying the amounts of silver, or of mercury, or of what not; but, after all, what do our specifications and our laws depend upon? They depend upon certain perfectly ideal things, namely, the definitions of the C. G. S. units. These things, it seems to me, must be followed for definitions, and it seems to me that the method adopted in the United States laws, if I am not mistaken, and practically in the English laws, is that the units are C. G. S. units, and are represented for practical purposes at the present time, that is, until the next change of the law, by so and so.

Suppose you define them today in terms of mercury and silver. Do you mean to say that in twenty-five years we shall not have one or two more figures? It seems to me that it would put us in a most untenable position. Now I firmly believe, and I am sure that everybody who knows the work that has been done by the German Reichsanstalt, by Doctor Kahle on the silver voltameter, and by means of the electro-dynamometer of Professor von Helmholtz, and in the English National Physical Laboratory under Doctor Glazebrook, and this work is going on with greater rapidity now than ever before, will see that in the next five or ten years they can confidently expect the next figure on the Weston cell, the next figure on the ampere in silver, and I don't suppose we can expect another figure on the ohm for some years. One point more. Doctor Wolff has spoken of the analogy between the practical definition of the metre and these standards. That is an unfair analogy. The meter is a fundamental standard. You can not re-define the meter, because that would throw out every measurement of every length and everything depending upon lengths ever made. We can say the earth is now supposed to be so many metres around. The meter is a definite thing. There it is, and there is the kilogram; that is one and indivisible. The "second" is derived from the motion of the earth. You can not make standards of these any better, you can not re-define them. But these electrical units are quite different. They are not

a bit like a meter. Can you make a standard ampere? Bring it here, and say, "There is an ampere!" You can not do it with a volt; you can not do it with an ohm. But it is different with a metre bar. It seems to me, therefore, that the British conservatism voiced by Doctor Glazebrook is the best course to be adopted by the International Congress. In five years, or ten years, your government would have to change your laws, for it would satisfy you no better. I don't believe any electrical engineer will ever be satisfied any better by the suggested laws than by the laws we have now. The only laws fixed are the laws of nature.

PROF. H. S. CARHART: I want to preface what I have to say by remarking that the province of the official delegates from this country, of which I have the honor to be one, is not to make laws at this Congress, or to determine anything for our government, but only to make recommendations. It agrees, therefore, precisely with the province of the delegates from Great Britain. And, moreover, we have nothing of a revolutionary character, I may say, in mind; but we have thought that it would be very useful if this International Congress could discuss these questions, and if out of these discussions comes ultimately greater uniformity in the definition of units and electrical standards than exists at the present time.

I am quite willing, therefore, to agree with what Doctor Glazebrook has said with respect to the definition of the units, or with respect to the volt, particularly as outlined in the first part of his remarks. It may be well to emphasize a little the fact that standard cells, either of the Weston normal type or of the Clark type, can now be made with greater uniformity, and show greater consistency than has been possible until within the past year; and I am quite convinced that the very strong adherence shown to the silver voltameter by some of our European friends is based upon difficulties encountered in the past in the reproducibility of standard cells. Fortunately now all over the world the difficulty has been traced to the mercurous sulphate. I should like to emphasize that point a little, because Doctor Hulett and I have found in our investigations that we can contaminate the solution of cadmium sulphate with 1 per cent of zinc-sulphate solution without affecting the e.m.f. at all. We can contaminate the cadmium amalgam by using one hundredth part of zinc to 99/100 parts of cadmium, with a difference in the result of perhaps not more than five parts in one hundred thousand; so that the difficulties on the score of contamination by zinc, which is the impurity to be feared, are almost inappreciable. Also, I think we have devised a method of preparing the amalgam which obviates the difficulties of oxidation. We have now a standard method of preparing the cadmium amalgam and zinc amalgam, and I believe the difficulties in the way of the preparation of the mercurous sulphate have also been removed. Either our method, or one of the methods tried at the National Physical Laboratory in England, will be satisfactory.

No simpler method than the electrolytic method could be devised if proper precautions are taken. With cells set up in accordance with the method of preparation to be outlined in my paper in section C on Thursday, we can be sure of an agreement to within one part in ten thousand; and my colleague, Doctor Hulett, who unfortunately is not here on account of sudden illness, believes we can be sure within five parts in one hundred

thousand. I believe we shall all agree that this is quite near enough for practical purposes. The difficulties, therefore, in the reproducibility of the Weston normal cell, with a saturated solution, have been removed. I am quite willing, however, to wait for the results of the investigations now in progress at the National Physical Laboratory relating to the e.m.f. of the Weston normal cell, as we have agreed to call it. Perhaps the National Bureau of Standards at Washington will also undertake to measure this e.m.f.; and if we all get concordant results in three different places I hope everyone will be prepared to accept these results for practical, and possibly for legal purposes.

Now, with respect to the other point raised very properly by Doctor Glazebrook, as to which of the two electrical units we shall employ as fundamental, though they are both derived units for purposes of electrical measurement. I do not find myself in accord with his position, and I shall endeavor to give my reasons. We are all agreed to take the ohm as one of them. On that point there is no difference of opinion or practice; but I hope we may come within a short period to an agreement to adopt the volt as the second of these units rather than the ampere; and there are several reasons why we should employ the standard cell for these purposes rather than the silver voltameter. We wish to have concrete standards. It certainly is easier to have concrete standards of e.m.f. than it is to produce a concrete standard for an ampere. You can not keep an ampere locked up in a case; and while you may represent it by an ampere balance, it is only indirectly, after all, a standard ampere. The silver voltameter does not measure current directly at all, and any one who has attempted to keep a current constant, as indicated, for example, by a potentiometer, for half an hour, will agree with me that it is at present utterly impossible to maintain an absolutely constant current for five minutes. So the ampere as derived from a silver voltameter is only an inference, which all of our friends must admit.

Now can we establish the electrochemical equivalent of silver with sufficient accuracy? I doubt very much if it is known within one part in one thousand, so as to agree with our ideal definition. If it is not known, the scientific man will never be satisfied until he knows it to a nearer approximation than it is known at present; and even though it might be sufficient for electrical engineering to allow it to stand as it is, it will not be sufficient, I am sure, for Doctor Glazebrook and Doctor Stratton and for others interested in these subjects. We must pursue this subject if we are true to the scientific doctrines that we believe in. We do not know the e.m.f. force of the standard cell to within something like one part in one thousand. Then the question is how shall we better determine these constants? Now it has been admitted, and no less freely by our German friends than others, that the practical method of measuring currents is by the potentiometer and standard resistance. Everybody thinks that we must use this method in order to have a wide range of accurate measurements. We are all agreed then that we are going to use a standard cell, whether we define our legal volt from it, or not. Now then, if we admit the silver voltameter as our second fundamental unit, we must determine the electrochemical equivalent of silver by means of

some ampere balance, such as is now being constructed in the National Physical Laboratory for example, or by some form of electro-dynamometer such as my colleague and I are using, and then we must proceed from that by the use of the silver voltameter, and by a second step to determine the e.m.f. of the standard cell. That is the method that has been adopted in the Reichsanstalt, a method which I am sure you must admit is not above criticism, if you have examined the exact process by which the e.m.f. of the Clark cell was determined. I am not disposed to say that this was not the best method that could be used at the time; but I do not think it is the best method possible now.

Instead of arriving at the e.m.f. of the standard cell by a second process, in which all the difficulties of the silver voltameter are introduced, on top of the difficulties in measuring current in absolute units, why not proceed directly to the determination of the e.m.f. of the standard cell without the intervention of the silver voltameter at all? We should then have the standard ohm, upon which we all agree, and we should determine the e.m.f. of the standard cell by absolute measurement with some form of ampere balance in exactly the same manner that we determine the electrochemical equivalent of silver. Why not eliminate this intermediate step of determining the electrochemical equivalent of silver, in order to arrive at a practical current-measuring device? I do not see how the argument can be avoided. When we have reached an agreement as to the specifications for setting up the Weston normal cell, it will be much easier and simpler to proceed directly to measure its e.m.f. by means of an absolute ampere balance and to say, "That is one of our fundamental standards," rather than to pass through the electrochemical equivalent of silver, and then to the e.m.f. of the standard cell, and to a practical method of measuring current.

MR. H. E. HARRISON: I can add little or nothing to what has been said by Doctor Glazebrook about the standard cells, but the subject of the units has yet to be discussed. This subject we have also considered carefully. The C. G. S. system is used too universally to be readily changed. It would be useless to tinker with it; it must be kept as it is, or must be discarded entirely. The only justification for discarding it would be the introduction of a new system which had none of the defects of the old.

For example, there is the fundamental difficulty of the 4π , discussed by Doctor Kennelly in his paper, and again referred to by Professor Ascoli this morning. If 4π is made to disappear in one place it crops up in another. We do not see how to get rid of it. We can only look to our more inventive cousins on this side to devise a sphere whose surface shall not be 4π times its radius squared.

Again, Doctor Kennelly suggests that the absolute units shall be named, because all germs and even weeds have names. I differ from him. A noxious germ is not used because it is named. But the naming of the two absolute systems would cause them to be used so that when reading an electrical paper we should frequently be in doubt as to which of three units was meant. The advisability of naming the magnetic units will, I believe, be discussed in another place. Up to the present very little difficulty seems to have arisen in their use.

I would remind you that at the Paris Congress of 1900, names were given to two of those units; yet in England, at all events, only about one in a hundred engineers would know the meaning of the Gauss or Maxwell.

Personally I should like to see these units named, but if engineers will not use these names already given, it seems useless to name others or to change those already given.

DOCTOR KENNELLY: There are two distinct questions involved in this discussion which should be dealt with separately. The first is the volt question, and the second is the unit question.

In regard to the volt question, I speak from the standpoint of the practical man. In various countries, I believe, and certainly in this country, the Clark cell is legalized as 1.434 volts, at 15 deg. C. I believe it is generally admitted not only in this country, but also in England, in Germany and in France, that a closer approximation to the e.m.f. of the Clark cell is 1.433, and that, to the best of our knowledge today, 1.433 is the e.m.f. of the Clark cell at standard temperature. That means that to the best of our knowledge we are inaccurate in our legal value by, roughly, 1/10 of 1 per cent, or, roughly, one part in a thousand. That does not affect some countries, because some countries have not legalized their Clark cell. They have legalized the ampere and the ohm. In Germany, for example, I understand that the Clark cell is taken at 1.4328 volts at standard temperature. But we all use Clark cells, and in every practical commercial laboratory the Clark cell is the basis of measurement. Only in the best standard national laboratories is the standard ampere the basis of reference.

Now, it is a matter of importance from a practical standpoint, from an engineering standpoint, that there should be a discrepancy, between our best knowledge and our laws, of nearly one part in a thousand with the practical working standard that we all employ and shall continue to employ. If we maintain that condition of affairs unchanged, the result will be that we shall either infringe the law, by employing our best knowledge in our practical work, or, if we follow the law, we shall be acting in opposition to the best of our practical knowledge. One part in a thousand is by no means unimportant, because one-tenth of a volt has an appreciable effect upon the lifetime of an incandescent lamp, and contracts based upon voltage and lifetime of incandescent lamps are liable to be appreciably affected by an error of nearly one-tenth of a volt in 120 volts, which is distinctly discernible on a Weston laboratory standard voltmeter.

This is a discrepancy that should be eliminated in some way. There is difficulty in doing this internationally because of the difference of laws in different countries, and we should have some method of overstepping this difficulty.

There are two proposals: one is to abolish the Chicago recommendation of 1.434 volts, by substituting for it a new standard, the cadmium cell or Weston normal cell. That would remove, of course, the 1.434 and its discrepancy. This course would be advantageous if it could be followed. If this course could not be followed, the next best thing would be to have the 1.434 changed somehow to 1.433 for the present. That would at least bring our best practical knowledge into conformity with working standards and with national law.

Moreover, with an error of one in a thousand for the standard cell, an error of one in five hundred is introduced into power measurements. This error of nearly one part in a thousand becomes $\frac{1}{2}$ of 1 per cent when power is measured, depending upon the e.m.f. of the Clark cell or upon its derivatives.

It would surely be unworthy of the International Electrical Congress, if, agreeing that 1.433 was the best value for the e.m.f. of the Clark cell, it should leave the legalized existing value 1.434 untouched in its recommendations.

The question whether the volt standard should take the place of the ampere standard is more serious, because it affects the legislation of different countries. I agree with Doctor Carhart and a number of the other gentlemen here, that the concrete volt standard, since it can be carried about like an ink bottle, is better than the fundamental ampere-standard, which must be set up under very careful conditions in a standard national laboratory. For this and other reasons, the combination of the standard volt and standard ohm would be better as concrete standards than the standard ampere and the standard ohm. We have to consider, however, the requirements of the laws adopted in other countries. It might not be practical to make a change of that sort at the present time. But whatever the conditions may be in regard to the legislation of the different countries we should all try to get our units in as close agreement as possible. I believe that when some countries take the Clark cell as 1.433 volts and others take the Clark cell as 1.434, the discrepancy is one which affects commercial and practical interests to a small but appreciable extent, and one which in some way, if only provisionally, should be overcome.

Now, as to units in general. The first question naturally arising in connection with that subject is as to whether the units should be rationalized or not. There is much to be said on that question. It is a large subject and there is much literature upon it. My personal opinion would be that we had better leave well enough alone at the present time, and not try to upheave all of our standards, our ohms, volts and amperes, for the sake of a 4π . Whatever may be the outcome in the future, I believe it almost impossible at this time to upheave legislation and universal practical applications, by changing units from an irrational to a rational basis, however much the rational basis might be desired. So I will, with your permission, pass that question and come to the actual C. G. S. units as they stand, and assume that it is our desire to maintain and to perpetuate these units. In the scientific world generally, in chemistry and mechanics, etc., all units are coming more and more, I believe, to be founded upon the C. G. S. system. Consequently, it would not be desirable for us to draw the electrical branch out and put it apart from the C. G. S. system used in the other divisions of the scientific world.

We learn the electrostatic and electromagnetic C. G. S. systems, and having learned therein the relation of magnetic and electrical units to each other, we are told by our teachers that this subject is altogether for the priesthood—that it is too good for us and that we must content ourselves to work with certain derivatives of these units, in which the ohm is 10^9 ,

and the ampere 10^{-1} , and the volt 10^0 . This is a great misfortune. It is true we must be content with the practical units. No one urges that we should try to upset the ampere, ohm and volt. We owe much to the gentlemen who established the ohm, ampere and volt, and I would do nothing to depreciate the magnitude and importance of their work, which must stand for the present. I do not for one moment advocate the upsetting of the practical system, because it has come to stay, and all our instruments are marked therein. It is good enough for most purposes. The plea I put forward is that we are hampered in our development of electrical knowledge—hampered in the development of electrical theory and in the apprehension of electrical phenomena, by carrying on trains of thought in this artificial system—artificial because in this system the unit of length is a quadrant of the earth, and the unit of mass is an extremely small subdecimal of a gramme.

This difficulty, which everybody must have encountered in dealing with new electrical applications of any kind, is so serious that hardly anyone will advocate carrying out a long process of reasoning in the practical system. In such cases everyone will naturally fall back upon the C. G. S. system.

It seems only reasonable that fundamental units which have to be used, at least in theoretical investigations, should receive names, and perhaps the simplest method of naming these units is to employ prefixes in connection with the practical units.

Prof. JOHN PERRY: I don't know but that enough has already been said by our English delegates, but I should like to say a few words. Doctor Glazebrook laid his views before a class of people interested in the subject in England, and I think I may say pretty well everybody in England is in agreement with Doctor Glazebrook. I think, also, most of the people I have talked with on this subject would be in perfect agreement, and would be delighted to hear what Doctor Webster remarked.

I think our position really ought to be that there should be as few concrete units as possible. Can we base everything upon the three, the cm, the gramme and the second? Are all others derived from them? If so, as time goes on, should we not be able to define these units with greater and greater accuracy? Do you mean to say that if we settle now on 1.434, for example, that possibly twenty-five, fifty or one hundred years hence we would not want to alter these numbers?

Now, Mr. Carhart's whole argument seemed to me to be based on the idea that we must have the ohm, the ampere and the volt all concrete illustrations. We differ in this point altogether. We have the three concrete examples, and regard all these as derived from them. We say 10^9 C. G. S. make an ohm, 10^8 C. G. S. e.m.f. make a volt, and 10^{-1} C. G. S. make an ampere. We say that these are derived, and, as time goes on, more and more accurately, from the C. G. S. system. We could put three concrete illustrations as giving for the time the very best concrete examples of the three fundamental definitions. As close as we can get now we give the numbers. Now Doctor Kennelly's remarks illustrate, I think, what I would call the British point of view. One and four hundred and thirty-four thousandths has been settled upon by the United States. It would

be the easiest thing in the world to alter 1.434, but as part of the law system of the United States at the present time it should be 1.434, so you can not, without altering the law, get to an approximation. You are going now to make it 1.433, and in the course of a few years you will want to alter it to something else.

I think on the whole, it was better to adopt the plan adopted by England, to base everything on the C. G. S. system, than that of the United States, in which the C. G. S. system is not referred to at all.

I am, and always have been, in favor of giving up that wretched 4. I know perfectly well that 100 years hence everybody will be blaming us because we didn't take the bull by the horns, face the difficulty and get rid of it at once. I am in favor of it now. I think sooner or later it will be done.

I was one of the first, probably the first, to point out the importance of our having magnetic units agreeing with the volt and ampere and ohm. I might therefore be supposed to be prejudiced in favor of that system. I might say that I have completely given up the idea that it is good to have that system. In my practical work, I have always found it is easy, not troublesome, not giving rise to any kind of complication, to convert everything into C. G. S. units. It strikes me that a number of people in this country are too logical. They have the ohm, the ampere and the volt, exceedingly convenient, I believe, in spite of what has been said, exceedingly convenient units, but they want to make a complete set of units. I really think they are too logical. I think it is a mistake. I think we always ought to look to the C. G. S. units as our real units, and that those convenient units, the ohm, the ampere, the volt, and the henry, are of sufficient convenience.

Now about this other point concerning names. Dr. Kennelly, are you not asking for far too many names? If you are going to give names to the C. G. S. units, is there anybody who will say they are necessary; would they even be convenient? I think not. Anybody knows the C. G. S. units. I am in perfect agreement with Doctor Glazebrook and with Professor Webster.

DOCTOR WOLFF: In the main, I agree with those who have participated in the discussion as to the desirability of not taking any radical action at the present time. At the close of my paper I expressed the hope that this Congress would give a definite expression to its opinions, which might form a basis for further discussion, and eventually lead to international agreement, so that all nations might have exactly the same laws.

Now, if anyone will take the trouble to examine the laws* he will see that there are numerous points of difference. I am quite sure that our English friends will agree that it is not wise to define a unit in a number of different ways. It certainly must lead to inconsistencies. For example, if the volt is defined in terms of the ohm and the ampere, or in terms of the C. G. S. units, it will not be in agreement with the value 1.434 of the Clark cell, which is legalized in various countries. I hope that the result of the deliberations of this Congress will be a set of resolutions

*See *Bulletin*, Bureau of Standards, No. 1.

expressing the views of the Congress, and some arrangement for a future international assemblage at which some final action can be taken.

I can not quite understand the attitude of some of the gentlemen who prefer the C. G. S. units (which I will admit are the best theoretically) to practical units defined in terms of concrete standards. It seems to me that if we have reproducible concrete standards, and determine their values as well as we can by absolute measurements in such units, it enables every one who has a Clark cell and a standard ohm to express all his measurements in C. G. S. units to as close an approximation as he possibly can. In other words, Professor Webster would find that the simplest method for determining the value of a quantity in absolute units is by comparison with concrete standards, in terms of which the legal units should also be defined. Then again, the question has been raised, as to whether it would not be necessary to modify the values adopted for such concrete standards, as new absolute measurements are made. I think that is answered pretty well by the fact that it has not been found necessary to modify the value of the ohm, and in fact I don't think that anyone now thinks of suggesting a modification. Suppose we should ever find that a number of absolute determinations all agree in the value 106.28 cm for 10° C. G. S. units of resistance. I do not think it would even then be necessary to make any change, because measurements might still be expressed in terms of 106.3 cms, and in the few cases where they would have to be reduced to absolute measure, the correction could be applied.

There is this same question in relation to the cubic decimetre and the liter. I do not think we are very seriously hampered by the fact that the latter is our practical standard of capacity, and not the cubic decimetre.

In other words, the suggestion that it would be necessary to surrender the C. G. S. system entirely is answered by definite reproducible concrete standards furnishing also the best means of carrying out measurements in the C. G. S. system.

It was asserted that it would be best to accept a standard which is based on the fundamental laws of nature. I think that was Professor Webster's argument for the silver voltameter; but is not the electromotive difference between the metal and the salt of the metal just as fundamental as the electrochemical equivalent of silver?

If methods can be devised for obtaining materials sufficiently pure, we can be sure that they have uniform electromotive properties, and recent work shows that such is the case for the materials employed in the standard cell.

In conclusion, I might say that my stand is that the laws we now have differ so radically, that I think all nations would agree to their repeal, and to the substitution of a new law which has the support of all.

PROFESSOR CARHART: I do not want to take up the time of the Section except for a few minutes. I am sorry that Professor Perry has gone out. I rise particularly to compare the definitions in the laws of the United States and those adopted in Great Britain. I fail to see the difference. The language is slightly different, but they are essentially the same, and I wish to say that I do not include now in my remarks the Schedule of

Standards one, two and three. Those, I suppose, are peculiarly characteristic of the snug British Islands, but with them we have nothing to do. They are concrete standards that they wish to preserve in the Board of Trade. I refer to the definitions preceding the Schedule of Standards. Now in the United States laws, we have defined the terms in C. G. S. units. You will find them in the first two, that is, the unit of resistance and the unit of current, but not in the third, the unit of e.m.f.; we followed the recommendations of the Chicago Congress of 1893 in saying that these were represented *substantially, sufficiently for practical purposes*, by such and such concrete standards. We did not assume or assert that there was an exact agreement between the theoretical definitions and the practical units. Now what do you find in the definitions in the laws of Great Britain? You find, first, the ohm, 10^9 , expressed in slightly different language, but exactly the same thing. You will find it is represented, not substantially, but by the resistance offered, so and so. There is the other half of the definition, almost exactly as we have it. With respect to the ampere, we have again the same thing—the theoretical definition, and then the practical definition. We have them, also, in the British statement about the volt, and both of them we now know to be incorrect, as far as the practical definition is concerned, at least to one part in one thousand. For the volt, we have no theoretical definition in the laws of the United States; the British have stated it as 10^8 C. G. S. It is stated that this “is represented by 0.6974 (1000/1434) of the electrical pressure “at a temperature of 15 deg C. between the poles of the voltaic cell known “as Clark’s cell, set up in accordance with the specification appended hereto “and marked ‘B’.” That is exactly equivalent to the statement of our law; both are wrong. I don’t see that they adopted any different position from ours, except as to their standards, which I take it is a special and individual thing, and has nothing to do with these definitions. The positions they have taken, and the positions we have taken, are identical.

DOCTOR GLAZEBROOK: May I ask a question? I do not see in the United States definition, on page 3 of this appendix, any statement that the ohm is 10^9 C. G. S. units of resistance. I do see that in the British statement, and that, I understand, is the difference between Professor Perry and Professor Carhart.

PROFESSOR CARHART: “Which is substantially equal to one thousand million units of resistance of the C. G. S. system.”

DOCTOR GLAZEBROOK: I see. I beg your pardon. There is practically no difference on that point. There is the point, however, that the actual British legal standards are described in the schedules and not the definitions. I think a legal question would turn on that schedule and not on the definitions.

May I mention one other fact which I omitted when speaking before? It is not a matter of argument at all. Just as I left England, I was handed, by Mr. Trotter of the Board of Trade laboratory, a note of a determination of the e.m.f. of the Clark cell which he had completed. He passed a current through his ammeter, and the value thus obtained for the e.m.f. of the Clark cell is 1.4329 volts.

DOCTOR WOLFF: One further remark. The law of the United States

is as follows: "The unit of resistance shall be what is known as the "international ohm, *which is substantially equal to one thousand million* "units of resistance of the centimeter-gram-second system of electromag-
 "netic units, *and is represented by the resistance offered to an unvarying*
 "electric current by a column of mercury at the temperature of melting
 "ice fourteen and four thousand five hundred and twenty-one ten-thou-
 "sandths grams in mass, of a constant cross-sectional area, and of the
 "length of one hundred and six and three-tenths centimeters." The
 English law defines the unit of resistance 10^9 in terms of the cm and
 the second of time, and defines it also as represented by the resistance
 offered to an unvarying electric current by a column of mercury at the
 temperature of melting ice 14.4521 grams in mass, of a constant cross-
 sectional area and of a length of 106.3 cms.

This is the main point I wish to emphasize.

PROF. WEBSTER: I should like to inquire from Prof. Kennelly and
 Dr. Glazebrook what the chances are in any court in England or in
 America where a decision would be taken involving one part in one thou-
 sand on quantities having to do with electrical engineering, and whether
 Professor Kennelly knows of any supply company in this country which
 maintains a voltage of one-tenth of a volt. I know of none, and I believe
 that such a suit at law is extremely unlikely to come up. I don't want it
 interpreted that I am in the least out of sympathy with the policy of
 defining certain units. But to close the discussion of Professor Wolff
 on the C. G. S. system as against the theoretical units, I should like to
 call the attention of the members present to the results of the adoption
 of that policy on the determination of a magnetic field. To think we could
 no longer swing a magnet in Gauss's old method! This dates back to
 the beginning of electric measurements. We could not swing a magnet,
 and find out what its field was, without looking back to determine the
 weight of mercury and of silver and of all that, to make the correction
 on this determination of our result of this magnetic field. That is the
 most fundamental electric measurement made in any laboratory.

DOCTOR WOLFF: In answer to Professor Webster's last objection, it
 might be stated that the accuracy of magnetic measurements hardly ex-
 ceeds, in most cases, one in one thousand, and that we are fairly sure
 that the fundamental electrical units, even with our present knowledge,
 would be defined within that; so we would go on making our magnetic
 measurements just the same as we have from the beginning, and we would
 not need to think of the column of mercury corresponding to the ohm,
 or of the specifications for the standard cell. I think that answers that
 objection. If the values adopted for standards are in close enough agree-
 ment, that is $\frac{1}{2}$ of 1/10 of 1 per cent, I think there will be no further
 practical difficulties.

PROFESSOR WEBSTER: I think it is, who will determine your volt? It
 is determined by somebody, Lord Rayleigh, or Doctor Kahle, or someone
 else. I am perfectly sure that is the case. If not, what is your volt,
 and what is the difference whether it is 1.434 or 1.4328.

MR. HARRISON: To throw some light on the legal side of the discussion,
 I may state that I have acted for some years as an inspector under the

Board of Trade. I have occasionally had to test meters under conditions such that I could not rely upon my own measurements to within much under one per cent, yet during the whole time I have so acted, the results I have given have never been questioned in a court of law.

Dr. C. H. SHARP: Regarding Professor Webster's remarks, I wish, in the first place, to call attention to the fact that these electrical units are things to be used. They are things to be used by the practical man. I must say that I am entirely out of sympathy with the hypothetical troubles of Professor Webster in swinging a magnet. If it should be necessary, in this connection, for him to consult his conversion tables, that can be no great hardship. It would be a lesser hardship than for the busy practitioner to be obliged to speculate as to the value of the volt used in calibrating an instrument or a lamp which he has imported from Germany.

Furthermore, as regards the significance of the quantity of 1/10 of 1 per cent in engineering, I think that Professor Webster's idea of the importance of such a quantity is quite erroneous. The quantity 1/10 of 1 per cent is of commercial significance. Suppose, for instance, that a change of the fundamental standards were made, by which all the energy sold to consumers in this country were affected by a change of 1/10 of 1 per cent in the standard of voltage. That corresponds to one part in five hundred in the energy, and in summing up the cost to millions of consumers, it becomes quite significant.

Prof. Webster asks what company maintains its voltage constant to within 1/10 of 1 per cent. No company does this, but many companies maintain their standards correct within 1/10 of 1 per cent, by the use of potentiometers and standard cells.

Roughly speaking, one-fourth, perhaps more, of all incandescent lamps manufactured in this country, are sold under contract specifications, under which the price to be paid for the lamps is regulated within certain limits according to the life and to the candle-hours value which they show; the latter value being determined by life-tests of representative lamps. In making these tests of lamps, a work in which I am personally interested, and with which Doctor Kennelly is also perfectly familiar, we find it absolutely necessary to maintain our voltage correct within 1/10 of 1 per cent. We can not maintain our pressure always within 1/10 of 1 per cent, but we can maintain our average pressure within 1/10 of 1 per cent, and keep all variations within extremely small limits. Now a variation of 1/10 of 1 per cent in average pressure makes a difference of roughly 2 per cent in the candle-hours output of incandescent lamps, which difference might involve a forfeiture on the part of the selling company or of a premium to be paid by the consumer. Considering further that the total number of lamps so affected amounted to about ten millions last year, it will be seen that a difference of 1/10 per cent in standards has a decidedly commercial bearing in this field. In our testing work we have had to face the question, "What is a volt?" We are obliged to say in accordance with the specifications of the American law, that a volt is obtained from the Clark cell which has an e.m.f. of 1.434 volts. I may say personally that I do not like to do this because I believe it is not so. Moreover, we find that a photometer lamp imported from Germany, stand-

ardized according to their laws, must be held at a different voltage from its marked voltage, because their volt is different from ours, and we have to take this into account in our measurements.

The standards which the practitioner requires must be in the first place concrete, such that he can take hold of, that he can transfer from one point to another; he wants standards which he can use directly, and not through the intermediary of secondary standards exclusively. He wants standards uniform throughout the world. As another consideration, if he can get standards which represent pretty closely multiples of the C. G. S. system of units, he is all the better pleased, but if they are a little bit off he doesn't trouble himself greatly about that, as long as everybody else is using the same ones. Consequently, I think it would mark a distinct step in advance, as far as electrical engineering practice is concerned, and it must be remembered that the accuracy attainable in engineering practice has increased rapidly from year to year, and the accuracy demanded is increasing as well—that it would be a step in advance, if we could abolish the silver voltameter, which few use practically, and beside the standard ohm, which we already have, adopt a standard cell, say the Weston normal cell, and secure the universal acceptance of a fixed value for its e.m.f. Then we would be on a uniform basis all around. It is very much to be hoped that some action will be taken at this Congress which will result in the course of a reasonable period of time in the adoption of some such system or its equivalent.

Dr. GEORGE W. PATTERSON: I wish to add a few words about the relative advantages of the standard cell versus the silver voltameter. I assume we all accept the present value of the ohm as the standard of resistance. To determine in absolute measure either the electrochemical equivalent of silver, or the e.m.f. of a cell, we use some form of absolute electro-dynamometer, calling it a current balance if we will. To determine the electrochemical equivalent, we must manipulate the silver voltameter, observe the time and weigh the silver deposited. To determine the e.m.f., we must balance the cell's e.m.f. against the fall of potential of the absolutely determined current over a standard resistance. This balance can be obtained fully as accurately as the time of deposit of the silver could be measured, to say nothing about the difficulties of holding the current constant, manipulating the voltameters and weighing the deposit. In addition, I believe the e.m.f. of the standard cell is more accurately reproducible than the deposit of silver in a voltameter. But the principal argument in favor of the standard cell, is its greater convenience in the laboratory; for in making laboratory measurements the reverse process must be gone through. This involves an enormously greater time for each observation, when using the voltameter, with no compensating advantage. Consequently, I favor the standard cell over the silver voltameter.

Mr. W. DUDELL: There has been a lot of discussion on the legal position of the matter which I will leave entirely on one side. I will say nothing about it. I will say this, however, that I think we all agree that the primary standards are those of the C. G. S. system. These are our primary standards, and, therefore, any other concrete standards set up for any purpose whatever are secondary standards. These secondary

standards are required to have special features to make them useful for international interchange, so that we can make sure that all the nations of the world are working in the same standards in their practical work. It is evident that these secondary standards will always be more or less at variance with the C. G. S. standards, for, as we work, year after year, we are getting more perfect apparatus for determining true values, and we shall find errors in our secondary standards. It seems to me, therefore, that it would be unwise to tie ourselves too tightly to these secondary standards.

The next question that arises is that these secondary standards must be easily reproducible, and they must be permanent. I look upon permanency as more important than the quality of being easily reproduced, as I think these secondary standards will be mainly kept by the large laboratories of the world, which all nations are setting up.

Then there is the third set of standards, which seems to have become confounded with the second. Such as the cell—an apparatus which is going to be carried about for practical purposes. The accuracy of these tertiary standards need not be very high. One-half of 1 per cent is pretty high accuracy for commercial purposes. An accuracy of $1/20$ of 1 per cent will satisfy all practical ends.

Among secondary standards is the mercury ohm. Nobody is going to suggest that we take a mercury ohm into a workshop. We make a tertiary standard, say a manganin coil, from it, which we carry about and use. The same will apply to the question of the ampere and the volt. It rather looks as though we should finally end with some form of dynamometer, or weighing apparatus, rather than an electrochemical phenomenon, as our secondary standard, with the mercury ohm. Most people seem out of favor with electrochemical standards. The silver voltameter is not convenient even as a secondary standard at present. Whether, in the end, the silver voltameter will prove to be more convenient to determine the ampere, than the cell to determine the volt, I think is a matter which will have to wait to be settled by the results of the work which is now going on all over the world. When that point is settled, I think the practical man will take the cell as his tertiary standard. It can easily be carried about, and can be used with a potentiometer. All the arguments as to which one is derived from the other, whether the volt standard is to be determined from the ohm and the ampere standard, or vice-versa, will not apply to the standard laboratories at all. They will establish the method which gives the most accurate result in making secondary standards. We have got very good tertiary standards of resistance, and from the results which have been brought forward here by Professor Carhart and others, we seem to be going to have cells as standards of e.m.f. almost as good as wire resistances.

The question of the permanency of the cell is a matter of great importance, if it is to be used in practice. I feel that these electrochemical apparatus, which are liable to be changed if short-circuited or ill used, will have to be referred back to the standard laboratories to make sure their value is right if we want to be certain of accuracy.

The next question is that of magnetic units. Doctor Kennelly, in the

beginning of his remarks, made a great plea for consistency in his units, and then, having gone so far with the Volt-Ampere-Ohm system, he proposes to be inconsistent and name the C. G. S. system, and he gave the reason on the board why there would be difficulties if we went on naming the Volt-Ampere-Ohm system.

If we take the three fundamental electrical units, namely, the e.m.f., the current and the resistance, to start from, we can make corresponding ones in the magnetic system which will be perfectly consistent. Although this system is more consistent, I must admit I am in favor of Doctor Kennelly's proposal of using the C. G. S. system for magnetic units; but I don't agree with him in giving them names. I feel that the C. G. S. system requires no names at all. If you are working with the C. G. S. system it is self-evident what you mean without having to name each quantity. I think a very good example of that is, when I go to ask for an avenue in the town, I don't ask for Vandeventer avenue; I simply ask for Vandeventer. It is never Thirteenth street; but Thirteenth. And I am rather surprised that an American should want to add another term to our names for our units when they are cutting words off in the ordinary things of life.

As to another proposition of Doctor Kennelly, in his original paper, which has been referred to here this morning, namely, the prefixes ab and abs, I totally disagree with any prefixes without definite numerical meanings. It would only lead to complications in the future. If we adopt prefixes at all, and name the whole of the C. G. S. units, I think the prefixes should indicate clearly what fractions these are of the practical units, as we are naming them from the practical volt, ampere and ohm.

In conclusion, I should like to ask Doctor Sharp one or two questions. He has made reference to the enormous amount of money $1/10$ of 1 per cent would mean in the supply of energy in the United States. I should like to ask where they buy their meters in this country which will measure to $1/10$ of 1 per cent. Unfortunately, on the other side, we have no meters that work to that degree of accuracy. He also speaks of lamp life testing accuracy, and refers to 2 per cent. It seems very extraordinary to me. I don't know of anyone in England or on the Continent that can approach figures of that sort at all. I would also remark that a small variation from the mean voltage makes a considerable difference in the life of the lamp.

CHAIRMAN NICHOLS: Allow the Chair to announce that the time for adjournment has passed, and although there is doubtless very much more to say, the Chair thinks that the debate should be closed by simply allowing Doctor Kennelly and Doctor Sharp, against whom definite points have been made, to reply very briefly to these points.

DOCTOR KENNELLY: I would like to say that a question of one-tenth of a volt in one hundred and ten, raised, to my knowledge, a very serious question some months ago, which might have involved a large sum of money, in regard to a contract concerning incandescent lamps. Of course, ordinary voltmeters are not read to one-tenth of a volt, nor are lamp-testing voltages maintained to one-tenth of a volt; but contracts for incandescent lamps are based upon their laboratory performance with a specified

voltage, and a change in the standard voltage amounting to one-tenth of a volt in the laboratory standard voltameter, when the average lifetime of lamps is under test, would have an appreciable effect and might involve disputes and losses of money.

DOCTOR SHARP: I think the point raised has been pretty well covered by Doctor Kennelly. It is a question of the accuracy of the standard from which we work. What is the normal? We must have that correct. We don't have meters in this country that register accurately to the tenth of 1 per cent, but we do test them with standards of that degree of accuracy. A difference of that magnitude may be of importance under certain conditions. If, for instance, a meter is guaranteed accurate within 2 per cent, and on test its error is found to be nearly that amount, differences of 1/10 per cent begin to count, and our standards must be accurate within that limit of error.

CHAIRMAN NICHOLS: The time set for the adjournment of this section is passed. If there is a desire to continue this discussion an extra session can be arranged for this afternoon, but I take it that there will be no such desire. Unless it is explicitly so expressed the Chairman will declare this section adjourned until Thursday morning at nine o'clock.

COMMUNICATED AFTER ADJOURNMENT BY DR. K. E. GUTHE: We are all greatly indebted to Doctor Wolff for his valuable paper, for the collection of the divers laws relating to the electrical units, and for the clear statement of the shortcomings of the various legalized systems.

That the present chaos can not be continued for an indefinite period is clear, but the time is not ripe for any radical changes in the present laws. If I understand Doctor Wolff correctly, he urges simply the adoption of some resolutions looking toward a future change, and to make suggestions as to the nature of the proposed changes.

It is indeed gratifying that so much progress has lately been made in preparation of the materials for the standard cell, but there is still a great deal to be done before we can be absolutely sure of the superiority of the cell over the silver voltameter. First of all, a thorough comparison of cells set up by different men, with materials prepared independently, is required; and in addition, the new cells must be kept under observation for a much longer period than has been possible so far.

The silver voltameter is not such a very inaccurate instrument, as it may appear from the objections which Doctor Wolff has carefully collected and so forcefully stated. I have shown, in a paper before this Congress,¹ that there are two types of silver voltameters giving results differing as much as one in two thousand, but with any definite form, for example, the one recommended by the Chicago Congress, the agreement is much closer, while the porous-cup voltameter can be relied upon to within one part in at least ten thousand.

It is true the measurement of a current by means of a standard cell and a potentiometer does not require as much experimental skill, and is more elastic than is the case with the voltameter, and it will always be resorted to in practical electrical measurements. But we should not strain

¹Paper before the section of Electrochemistry.

a point. We are speaking of fundamental measurements, and not of ordinary laboratory practice, and for the former the all-important question is the one as to the accuracy obtainable. For the practical engineer, it makes very little difference whether or not the e.m.f. of his standard cell is determined directly in absolute measure. It is always a secondary standard.

While deploring the present unsatisfactory state of the question, I fully agree with the propositions made in a recent publication² by the Reichsanstalt, warning against too precipitate action.

Redeterminations of the different electrical units in absolute measure are in progress, and, therefore, it seems wiser to wait for the completion of these investigations before the question as to the desirability of establishing concrete units is taken up, a question on which the engineer and the theoretical physicist will always differ.

²*Elek. Zeit.*, Vol. 25, p. 669, 1904.

THURSDAY MORNING SESSION, SEPTEMBER 15, 1904.

Pursuant to adjournment, the Section was called to order at 9 o'clock, Honorary Chairman Dr. S. Arrhenius presiding.

CHAIRMAN ARRHENIUS: We will begin the program for today, and I will ask Professor Child to read us his paper on "The Electric Arc."

Professor Child then read the following paper:

THE ELECTRIC ARC.

BY PROF. C. D. CHILD, *Colgate University.*

The ionic theory has been of great assistance in explaining the discharge of electricity through gases, and it has, no doubt, occurred to many, that it might also help us to understand the peculiarities of the electric arc. Three attempts at such explanations have indeed been published. The first was one by the present writer, which must now be considered as unsatisfactory (*Phys. Rev.* 10, p. 151). Two others, which are much more complete, have appeared recently, one by Stark (*Drude's Ann.* 12, p. 673) and one by J. J. Thomson ("Conduction of Electricity through Gases," p. 416). We are, however, far from having reached the last word in such an explanation. There is, for example, still great uncertainty concerning the action at the cathode, and this is the most fundamental part of all the phenomena. This paper, therefore, makes no pretense at being a complete explanation of the electric arc. It is rather an attempt to make plain the principles on which an explanation must be based, to consider the different views which are possible, to show what facts can be explained and what questions must yet be answered. It is a review of a theory in the process of becoming.

The discussion will require us to understand; first, what is meant by ions; second, how they are produced; and third, their effect on the potential gradient between two electrodes, especially in a place where ions, of one kind only, exist.

Definition of Ions.

Certain causes appear to break atoms into parts, some charged positively and some negatively. These parts have been called ions. They tend to attach themselves to uncharged atoms, and these clusters of atoms with their charges are also called ions. So that an ion may be defined as an atom, a part of an atom or a cluster of atoms which has a positive or negative charge. From the derivation of the word, it signifies moving, and the name is applied

to nearly anything that will move in an electric field, and is too small to have any other name.

This definition includes ions in liquid solutions, but in this paper we shall be considering only the ones which are found in gases. These have different properties from those of electrolytes and the phenomena of the arc are not the same as those existing when a current of electricity passes through a liquid. These differences can be better understood after the facts relating to the arc have been more fully discussed.

The movement of the ions constitutes a current of electricity. Ions thus render the space where they exist conducting, and by this means their presence is ordinarily detected.

Causes Producing Ions.

Ions thus formed do not continue indefinitely. They quickly recombine and again form uncharged atoms. Thus, to have a continuous supply of ions, there must be a continuous production. Among the causes producing them may be mentioned Röntgen rays, ultra-violet light, the impact of ions on atoms, chemical action, especially at high temperatures, and incandescent solids. Of these, two only will be of interest to us at this time, namely, the impact of ions on atoms, and incandescent solids.

Ionization by Impact.

Let us first consider ionization by impact. If ions exist where there is a field of force, they tend to move in a definite direction. Under ordinary conditions, they can move but a short distance before they collide with an atom or molecule of gas. If the atom or molecule is hit with sufficient velocity, it is broken into parts which are charged and which are indeed new ions. Thus, cathode rays and the negative ions produced by ultra-violet light or incandescent solids render the gas through which they pass conducting. It has also been shown by Townsend that positive ions will produce the same effect (*Phil. Mag.* (6), 6, p. 598).

The velocity of an ion at any instant depends on the force acting on it, and upon the distance covered since its last collision, or in other words upon the potential-difference through which it has passed since it was at rest. Consequently, to have sufficient velocity to ionize by impact, an ion must pass through a certain potential-difference. If the mean free path is too short, or the

electric force too small, no effect will be produced. The measurements made by Townsend indicate that the negative ion must pass through 25 volts in order to ionize in air, and the positive ion must pass through 70 volts (*Phil. Mag.* (6) 5, p. 395 and (6) 6, p. 613).

Ionization by Hot Solids.

It has long been known that an incandescent solid discharges electrified bodies. Evidence has more recently been brought forward, showing that if the incandescent solid is charged positively, the gas about it becomes ionized, but that few, if any, of the positive ions come from within the solid. If, on the contrary, it is charged negatively, the ions come from within. Thus, Richardson (*Phil. Trans. Roy. Soc. Lon.* 210, p. 497) states that when a platinum wire was heated for a long time in a high vacuum, it ceased to give off positive electricity, but continued to emit negative.

Places at Which Ionization Occur within the Arc.

To pass then to the arc, we find that it is commonly divided into three parts, the part near the anode, at which there is a sudden drop in potential, as *Aa*, Fig. 1, that through the arc, where the

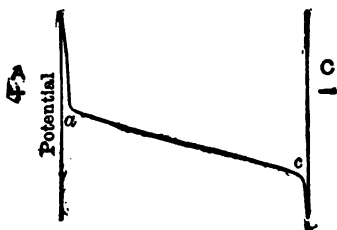

FIG. 1.— IS ANODE OF ARC; C IS CATHODE.

fall is gradual and nearly uniform, as *ac*, and that very near the cathode at which the drop is again sudden, as *cC*. In all of these places, a production of ions is to be looked for, and also within the incandescent substance of the cathode.

Potential Gradient in Gas Containing Ions of One Sign only.

To understand these phenomena, we may well begin with the case where ionization is produced in a gas between two electrodes, but not in their immediate neighborhood; we may next consider

the phenomena introduced by the impact of the ions on the electrodes, and finally may pass to the case where the electrodes are incandescent.

An example of the first will be found when two plates are placed on opposite sides of a flame, and at some distance from it. For example, let ac , in Fig. 2, be a space where ionization occurs. This

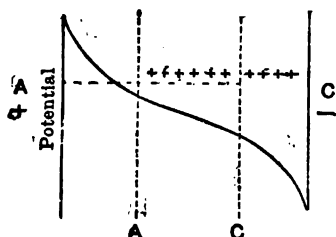

FIG. 2.—THE + AND - SIGNS INDICATE QUALITY OF IONS.

space will then contain both positive and negative ions. The space Aa will contain only negative and Cc only positive. Where there are ions of one sign only, the potential gradient varies greatly, and the drop in potential in the immediate neighborhood of A and C may become very large. The mathematical treatment of this proceeds easily in simple cases from the equation

$$\frac{d^2 V}{dx^2} + \frac{d^2 V}{dy^2} + \frac{d^2 V}{dz^2} = -4\pi\rho.$$

For example when the lines at A , a , c , C , represent infinite planes $V^2 > \frac{32 \times 10^{11} \pi i b^3}{k}$, where b is the distance Aa , V the change in potential through Aa , k the velocity of the ions per unit electric force and i the current per unit cross-section. The units used are volts, amperes, centimeters and seconds (*Phys. Rev.* 12, p. 79). Thus if i equals 10^{-8} amperes, b equals 1 cm, and k equals 10, then V is greater than 100 volts. Or if i equals 60 amperes, b equals .005 cm, k equals 1000, then V is greater than 274 volts.

Ionization at Surface of Cathode.

This discussion applies equally well to the case where ionization is produced by impact, as with discharge through a vacuum tube.

But here a complication is introduced. No negative ions come from C , and unless there is some new source of ionization, they all soon pass to A . Now the negative ions do not require as great electric force in order to ionize by impact as the positive. They are consequently the ones which produce new ions, and if they are drawn from the gas, all ionization will cease. Let us imagine that the gas has in some way become conducting, and that the space Cc has been cleared of negative ions. There will then be a drop in potential there. If this drop is sufficiently large, the positive ions will attain high velocities, and by impact on the boundary surface at C they also will ionize. We shall then have a two-sided action. The negative ions coming from this boundary surface will ionize in the space ca and the positive ions from ca will ionize at C .

As the negative ions thus formed begin to fill the space Cc , the drop in potential will become smaller. If, however, it becomes small enough, ionization at C will cease, and the potential difference will again become greater. For a condition of equilibrium the potential difference must be large enough so that positive ions will ionize at C .

Ionization at Surface of Anode.

We find that the phenomena at the anode are similar to those at the cathode. The essential difference is that the negative ions ionize by impact much more easily than the positive. The drop in potential at the anode is consequently less than that at the cathode. If no ions came from the anode, there would be a large drop in potential near it, as in the corresponding case with the cathode. This would here cause the negative ions to move with great velocity, and their bombardment of the surface layer at A would produce new ions. As before, a condition of equilibrium exists when the drop in potential is sufficiently large to cause many, at least, of the negative ions to produce new ones at the boundary surface.

Ionization at Cathode of Arc. Hot Cathode Necessary.

If now we pass to the arc, we find that it bears more similarity to the discharge in a vacuum tube than would at first appear. There is a drop in potential at the anode, a gradual fall through the gas, and another sudden drop at the cathode. Stark has

pointed out the similarity in his article on the electric arc, and in many respects I am following his explanation. The differences between the two phenomena are, that in the arc the temperature is very much higher, the current much greater, the drop in potential at the cathode much smaller, and the drop at the anode usually greater.

Of these changes, that at the cathode is most fundamental. Instead of being 300 volts it may be but 5 volts (*Phys. Rev.* 19, p. 70). Instead of being sufficiently great for positive ions to ionize by impact, it appears to be too small for any kind of ionization by impact. The essential condition appears to be that the cathode shall be very hot. Thus, Stark and Cassuto (*Physik. Zeit.* 5, p. 264) found that an electrolyte which could not have a high temperature, or a metal kept cold by rotation, could be the anode of an arc, but not the cathode. In some work done by the present writer, it was found that a carbon pencil, introduced into an arc, could be made to become the anode, even when it was not red hot, but that the cathode end of the arc could not be forced to jump to the pencil except when it was at a white heat (*Phys. Rev.* 19, No. 2). The experiments of Wientraube (*Phil. Mag.* (6), p. 95) agree with this idea, since he found that an arc could easily be formed between the cathode of a mercury arc previously formed and a new anode, but not between an anode and a new cathode.

Assumption That the Negative Ions Come from within the Cathode.

It must be that the positive ions ionize much more easily when the cathode is hot, or else that the cathode, on becoming heated, sends out ions, as in the experiments by Richardson. Both Stark and Thomson have made this latter assumption the basis of their explanations. They suppose the hot cathode to be the origin of the negative ions, and that the rise in potential need be only great enough, so that the positive ones by their bombardment of the cathode should raise it to the necessary temperature.

There are, however, two objections to this view. The first is that the current to a hot negative metal is not nearly as great as to the cathode of an arc. Even under the most favorable conditions, working with a substance that can be heated to the highest temperature, the rate of discharge to the hot cathode was only 2 amperes per cm^2 (*Phil. Trans. Roy. Soc.* 210, p. 497) while the current to the cathode of the arc is in the neighborhood of

255 amperes per cm^2 (*Phys. Rev.* 19, No. 2). This argument would be especially strong against any explanation that would assume no ions to be produced in the gas itself.

Secondly, there are many substances which melt and vaporize before a temperature is reached at which negative ions are given off. The most noteworthy example of this occurs with the arc between mercury terminals. Mercury vaporizes, especially in a vacuum, at temperatures far below that at which negative ions pass from a metal.

Alternative Explanation of the Cathode.

But, on the other hand, it cannot be denied that either the cathode, or else the region very close to the cathode, must be very hot. Even with the mercury arc, there is always an extremely bright point playing on the cathode. It may possibly be that it is not essential that the solid or liquid substance itself should be very hot, but only the boundary surface between the solid or liquid and the gas about it.

It may appear as if it was a matter of little importance whether we consider the negative ions as coming from within the solid, or from the surface layer about it. This, however, would not be a correct view. If the ion comes from within the metal, we may learn many things bearing on an explanation of the arc, by studying the discharge from hot metals. If, however, the phenomenon is one of the surface layer, then such an investigation would have little value for this purpose.

Effect of Oxide on Cathode.

Regarding this point there has been an interesting fact noticed by Stark (*Physik. Zeit.* 5, p. 81). It was found that if there was a bit of oxide upon the cathode, the arc would form much more readily than with a pure metal, the cathode end of the arc hanging to the oxide until it was consumed. I have also noticed that in a high vacuum the arc between iron terminals was started much more easily the first time than afterward, and also that the cathode end of the arc is continually jumping from one point to another. At times, the end of the arc will run up 2 or 3 cms from the end of the iron. Both of these phenomena are probably caused by the greater ease of maintaining the arc when the cathode end can find a bit of oxide.

However, the potential difference at the cathode is less with a mercury arc than with any other form, and, as far as known, there is no oxide present to assist in the passage of the current. So that we cannot yet be certain regarding the full significance of the fact noticed by Stark.

The drop at the cathode is affected less by the conditions of the experiment than that at the anode. Thus when a salt as NaCl is placed in the arc (*Phys. Rev.* 19, No. 2), when a metal is used instead of carbon (*Phys. Rev.* 12, p. 149), when the length of the arc, the amount of current (Mrs. Ayrton's "The Electric Arc," pp. 222 and 224), or the pressure of the surrounding gas is varied (*Phys. Rev.* 19, No. 2) there is either no change at the cathode, or at least it is smaller than that at the anode.

Thus some slight advance has been made in our knowledge of the action at cathode. We know that the cathode itself, or else the boundary surface, must be very hot, that in many cases oxide on the surface greatly assists in the passage of the current, and that the potential-difference there is nearly constant, but it is yet to be proven what the mechanism is by which the current passes from the gas to the solid.

Ionization in the Gas of the Arc.

In the gas itself we find the chief difference between the discharge in vacuum tubes and the arc, to be that the arc is very much hotter, and that the mean free path of the ions is through a much smaller potential-difference. I have discussed this point also in a preceding article. I may summarize by saying first, that it is necessary to assume some kind of ionization in the arc, for the mean free path of the ions is much too small to allow them to pass directly from one electrode to the other without many collisions, and the density of the positive and negative electricity is so great that rapid recombination must take place if there are collisions, and if recombination occurs then ionization must also occur. Furthermore the potential gradient through the arc cannot be accounted for without assuming ionization through the gas.

And, finally, the condition of the space between the electrodes after the impressed e. m. f. has been removed leads us to believe that the vapor itself has been ionized. That this space continues to be conducting has been shown by Blondel (*Lon. Elec.* 39, p. 655), Granquist (Mrs. Ayrton's "The Electric Arc," p. 91), and others.

If the electrodes alone produced ions we should expect the remaining conductivity to vary roughly as the cube of the length of the arc (*Phys. Rev.* 12, p. 79). Blondel, however, found such conductivity to be approximately independent of the length of the arc.

The cause for this ionization does not seem to be any rays sent off from the arc, nor does it appear at first that it is caused by impact. When ionization is thus produced, the electric force decreases as the density of the gas or as the amount of current decreases. Neither of these occur in general with the arc.

High Temperature of the Gas Essential.

On the other hand a high temperature appears to be an essential requirement. Except at low pressures, the heat necessary to maintain the arc remains constant as long as the electricity passing does not vary and increases when the latter increases. Moreover, the gas between the electrodes loses its conductivity after the impressed e. m. f. is removed, as if its conductivity were caused by its heat.

We have indeed no other examples of ionization being produced by heat alone, but since ions moving with high velocity break up atoms which they hit, an atom moving with high velocity must also be broken up when it hits an ion at rest. It must, therefore, be that at sufficiently high temperatures ionization will occur. Moreover the internal energy of atoms at high temperature is much greater than that at low, so that ionization may not require as great heat as would at first appear. As I have pointed out elsewhere, this would explain the behavior of the arc when the pressure of the surrounding gas is varied, as well as other phenomena.

If, however, the mean free path of the ions should become sufficiently great, their impact would cause ionization even at lower temperatures. In such cases less electrical energy would need to be changed into heat-energy, and the electric force would decrease. This indeed is what we find occurring at a pressure of a few millimeters (*Phys. Rev.* 19, No. 2).

The temperature, however, is only low when compared with that in the arc at atmospheric pressure. In all cases known, it is really very high, with the possible exception of the mercury arc, and it is probable that even here it is in the neighborhood of melting platinum (*Phys. Rev.* 19, No. 2). We should then explain the ionization of the arc as due to high temperature, except with

pressures of a few millimeters, when it is produced by a combination of high temperature and of impact of the moving ions.

Other Causes Affecting Ionization of a Gas.

The electric force within the arc, however, may be changed by various causes. Thus the introduction of NaCl may diminish the electric force to nearly one-half. Many other salts will produce a similar effect. Apparently such substances are easily broken up into ions.

Ionization at Anode.

On passing to the anode, we find again a sudden change in the potential, and yet the action does not appear to be as vital a part of the phenomena as that at the cathode. It is true that with a carbon arc the drop in potential at the anode is the greater, and the anode is supposed to be the hotter. It certainly is consumed more rapidly than the cathode, but it is by no means essential for all kinds of arcs that these conditions should hold. When a sufficient amount of such salts as NaCl or KNO₃ are introduced, the drop at the anode becomes the smaller. This is also true when an arc is formed between graphite terminals in a vacuum of less than .5 mm pressure, also with one between iron as anode and mercury as cathode (*Phys. Rev.* 19, p. 70).

Anode not Necessarily Hot.

It is also to be noted that the anode does not even need to be hot. As has already been pointed out, an arc may be started with a cold anode. It may not only be started but it may be maintained in this condition. With the mercury arc, no part of the anode ever becomes luminous. With the arc in a vacuum, the positive carbon may remain below red heat for some time (*Phys. Rev.* 19, No. 2). Stark and Cassuto have shown that an electrolyte, which vaporizes at approximately 100 deg. C, may be the anode of an arc (*Physik. Zeit.* 10, p. 267). In fact experiments performed by them indicate that the lower the temperature of the anode, the smaller the drop in potential. Their idea is that a hot substance sends off negative ions, and that emission of such ions produces an e.m.f. which at the anode opposes the current.

There thus appears to be no necessary requirements for the anode as there was for the cathode. The fall of potential there is usually large, but this is due to the fact that a large current is carried, at least for a short distance, by ions of one sign only. Thus it has been shown that when the distance was .005 cm, the velocity of the negative ion was 1000 cm per sec. for unit electric force, and the current density was 60 amperes per q. cm, there will be a drop of 274 volts. These are roughly the values which might be expected with the arc, if the current were carried at the anode entirely by negative ions. The mean free path of the ions in the arc is approximately .001 cm (*Phys. Rev.* 19, No. 2, and *Phil. Mag.* (6), 5, p. 385), the velocity of negative ions in the flame is 1000 cm per sec. for unit electric force (*Phil. Trans.* 4, 192, p. 499), and 60 amperes is the density of the current at the anode (Mrs. Ayrton's "The Electric Arc," p. 159). The drop of potential is kept from being as great as this, however, because of the production of ions by the impact of negative ones on the surface of the anode.

We have thus indicated an explanation for the drop in potential at the anode, but when we attempt to pass to details, to say why the drop with carbon is 35 volts and that with mercury only 6 volts, we are again confronted with our ignorance of what takes place at the boundary surface between gas and solid, and of the laws which govern this region.

SUMMARY OF EXPLANATION.

Thus the arc may be explained in brief as follows — the current is carried by ions. These ions are produced: First, either within the cathode, because of its high temperature; or, at the boundary surface, by the impact of the positive ions; second, through the gas by the impact of the atoms on the negative ions at high temperature; and third, at the boundary surface of the anode, by the impact of the negative ions. The electric force must be sufficiently great at the different points, so that the energy transformed will produce the required temperature.

Action in Arc not the Same as in Electrolyte.

It should be clearly understood that this explanation is not one based on the idea that current is carried by particles driven off from the electrodes, or by such ions as are produced in an electrolyte. With an electrolyte the anode is often eaten away, and a deposit

made on the cathode. At least with an arc between carbons, the anode is also consumed, and the cathode is sometimes built up. In many cases also, we have evidence that particles are driven off with great velocity from the electrodes. But, in reality, there is no evidence that an explanation based on these facts is correct. Surely the current of the arc cannot be carried by charged particles of matter, for particles move thousands of times more slowly than ions (*Phys. Rev.* 14, 241) and if the current were carried by them, there would need to be so many in the arc, that it would be more or less opaque. Nor is it simple to see how even a start for an explanation of the fall of potential could be made on such an assumption.

If it is suggested that the action is the same as with electrolytes, we have for reply the experiments described by Weedon (Paper presented before the Amer. Electrochemical Soc. at Washington in 1904), in which it was shown that a copper anode kept cool by water did not lose one fifteen-hundredths of what it should have lost, if Faraday's law were to apply, and that there was a slight gain at the anode.

It has been thought that some disintegration such as might be produced by boiling, or by oxidation, must occur at the electrodes. Such disintegration does ordinarily occur, but the experiments of Weedon again show that it is not at all essential.

This is not to deny that the vapor from the electrodes often has much to do with the passage of the current, but it is not until the heat has vaporized the electrode, and the gas is ionized as any other gas, that it plays any part in the phenomena. To take the simplest example, there is no doubt but that with the mercury lamp the mercury vapor carries the current, but to do so it must first be ionized as oxygen or nitrogen might be. It is altogether possible that it is more easily ionized than these gases, but the process is the same. The substance of the electrode may then have a decided effect on all parts of the arc, but it has this effect after it has been changed to a gas, and has been ionized as a gas is.

Explanation of the Counter E. M. F.

Let us now consider some of the facts which such an explanation makes clear. First, it explains the apparent counter e.m.f. of the arc. No other explanation of this has been given. No thermo-junction exists whose e.m.f. compares with that of the arc.

It explains also the sudden disappearance of the e.m.f. It has been shown that this disappears in at least $1/600$ second after the impressed e.m.f. is removed, though the high temperature and the conductivity exist for an appreciable length of time. The charge on a sphere may produce a potential of thousands of volts and yet can cause no appreciable current. In the same way the ions in the arc may cause an apparent counter e.m.f. of considerable magnitude and yet recombine after the current ceases without producing any apparent effect.

It Explains the Relation of Voltage to Current.

This would also explain the decrease in voltage when the current is increased. If the necessary condition for ionization in the arc is high temperature, it may be caused by a large current and small voltage as well as by a smaller current and large voltage.

There are also facts such as the difference in appearance between the anode and cathode, for which an explanation based on this conception may be offered.

Facts not Explained by This Theory.

There are other facts for which we have as yet no explanation. The most fundamental of these are the ones which have already been pointed out concerning the action at the boundary surface. There are also questions concerning the unidirectional character of the iron-mercury arc, the behavior of the non-arcing metals, and the velocities of the ions in the arc.

But this paper can scarcely go further into details. If it is shown how to take some of the steps on the way to a complete explanation, and will stimulate further experiment and further thought, it will indeed have served its purpose.

DISCUSSION.

Prof. H. T. BAERNES: I should like to ask Doctor Child one question. I listened with a great deal of interest to this very important paper. It contains much information in connection with the electric arc from a scientific point of view, and must lead to valuable results.

I should like just to ask further about the ionization by collision which takes place on the surface of the negative electrode by the impinging positive carriers. These carriers are swept to one side by the charge of the electrode?

PROFESSOR CHILD: I don't think there has been any experiment which would decide.

PROFESSOR BARNES: By impinging on the electrode, they set up, by collision, ionization?

PROFESSOR CHILD: Yes.

PROFESSOR BARNES: Is this set up on the surface of the electrode?

PROFESSOR CHILD: My idea is that it is on the surface. No experiments have been made to show that; but my belief is that it occurs upon the surface between the gas and the solid.

PROFESSOR BARNES: Have we evidence to show that an atom moves with sufficiently high velocity to set up ionization by collision with an atom?

PROFESSOR CHILD: No; in one sense we have not; that is, we have not, if it requires as much energy to break into parts an atom in the arc as one with normal temperature. We can explain the ionization in the arc only by assuming that at the higher temperatures the internal energy of the atom is so great that the electrons within it are on the point of flying from it. It would then, no doubt, require but a slight jar to disrupt it. The explanation of the arc which has been given is based on such an assumption.

In regard to the positive ions, it seems probable that after they become attached to the cathode they receive a negative charge which neutralizes the positive charge that they previously possessed.

DOCTOR CREW: This is an immensely interesting subject, and I should like to ask a question. Is the arc started by the ionization coming from the Joulean heat which is generated when the carbons are drawn apart immediately after their first contact?

PROFESSOR CHILD: When the electrodes are separated the movement of the electrons from one electrode to the other is interrupted by the film of gas which comes between them. The electrons when thus stopped produce heat and the production of heat is essential for the formation of ions in the arc.

MR. THOMAS: As to the nature of the force with relation to vacuum tubes. Is this force electro-magnetic?

PROFESSOR CHILD: My idea is that it does not require as great a difference of potential as in air. Wherever there are negative ions colliding in a field of sufficient force, there is ionization.

In one respect there is a decided difference between the arc in mercury vapor and in air. In the mercury vapor the negative ions acquire a sufficient velocity so that they produce ionization by impact without high temperature, whereas in air the velocity of the ions is much too small to produce ionization without the aid of high temperature.

MR. THOMAS: With regard to the heating of the anode, I find that a very slight introduction of air or other gas immediately causes considerable heating of the anode. There seems to be a concentration of that gas; it is not uniformly distributed throughout the tube. There seems to be an action carrying the gas to that point.

CHAIRMAN ARRHENIUS: Is there anyone else who wishes to speak? If not, we will go to the paper by Doctor Rosa and Mr. Grover, "Absolute Measurement of Inductance."

Doctor Rosa then read his paper entitled "Absolute Measurement of Inductance."

THE ABSOLUTE MEASUREMENT OF INDUCTANCE.¹

BY DR. EDWARD B. ROSA AND FREDERICK W. GROVER.

1. METHODS OF MEASURING INDUCTANCE.

Self-inductance may be determined in absolute measure (that is, in terms of resistance and time), by the methods of Maxwell, Wien, or Rowland. The first named is complicated and scarcely capable of giving results of high accuracy. The other two methods are probably capable of yielding results of satisfactory accuracy but, so far as we know, few results by these methods have been published, and none of a degree of accuracy equal to the results which have been obtained in the absolute measurement of a capacity.

The most obvious method of directly determining the inductance of a coil, originally proposed by Joubert, consists in first determining the impedance of the coil and then calculating the inductance after having found the ohmic resistance of the wire and the frequency of the current employed.

Brew² has given some determinations of inductance by this method, using a Cardew voltmeter, first in series with the inductive coil and second with the coil cut out. Knowing the resistance of the coil and of the instrument, and the frequency of the current, the inductance is calculated. The results on a single coil are given; they show considerable variations, as would be expected. Nothing is said of the wave form, although the formula employed presupposes a sine wave.

Several variations of this method are described by Gray³ and Fleming.⁴ According to Gray a non-inductive resistance is placed in series with the coil whose inductance is to be measured, and an alternating current passed through both. By means of an electrometer the differences of potential at the terminals of the non-inductive resistance R_2 , and of the inductive coil (resistance R_1

1. Communication from the National Bureau of Standards.

2. *Electrician*, Vol. 25, p. 206, 1890.

3. "Absolute Measurements," Vol. II, part II, p. 488.

4. "Handbook for the Electrical Laboratory," Vol. II, p. 205.

and inductance L) are measured. The inductance is then given by the expression

$$L = \frac{R_1}{p} \left(\frac{R_2^2 V_1^2}{R_1^2 V_2^2} - 1 \right)^{\frac{1}{2}}$$

p being 2π times the frequency of the current employed, which is to be as nearly simply harmonic as possible.

According to Fleming, we "first send through the coil a continuous current, and observe the potential difference of the ends of the coil with an electrostatic voltmeter, and measure the current flowing through it. Then repeat the experiment, using the alternating e.m.f. The ammeter should be a Kelvin balance, or dynamometer, or hot wire ammeter, suitable for both continuous and alternating currents. Adjust the voltage so that the current is the same in both cases. Then if A is this current, and if V is the volt-fall down the coil with continuous current, and V' that with the alternating current, and if R is the resistance and L the inductance of the coil, we have

$$A = \frac{V}{R}$$

$$A' = \frac{V'}{\sqrt{R^2 + p^2 L^2}}$$

where $p = 2\pi$ times the frequency of the alternating current."

Therefore,

$$L = \frac{R}{p} \sqrt{\frac{V'^2 - V^2}{V^2}}$$

Or the volt-drop may be kept constant and the current measured in each case. Then

$$L = \frac{R}{p} \sqrt{\frac{A^2 - A'^2}{A'^2}}$$

If the current is not of sine wave form, a correction must be applied.

2. THE METHOD OF THIS PAPER.

It occurred to us that a modification of the method quoted above from Gray would be better adapted to precision measurements than any other proposed. Instead of using the electrometer to measure the difference of potential at the terminals of the inductive coil and of a fixed resistance R , we vary the resistance R until the difference of potential at its terminals is equal to that at the terminals

of the inductive coil, as shown by an electrometer. Then, since the alternating current I is the same in both, and a sine wave form is assumed, $I R = I \sqrt{r^2 + p^2 L^2}$, r being the ohmic resistance of the inductive coil, and

$$L = \frac{1}{p} \sqrt{R^2 - r^2}. \quad (\text{See Fig. 1.})$$

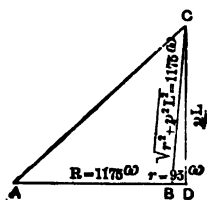

FIG. 1.

This is an extremely simple formula, in which only two quantities, the resistance and the frequency, have to be determined accurately. The resistance r is usually so small that an approximate value for it is sufficient. In the simplicity and directness of the method, and the small number of quantities to be determined, lie the advantages of this over other methods.

The chief objection to this method is that it is necessary to have a perfect sine current, or to know the exact form of the current wave in order to calculate the correction due to any harmonics that may be present. So far as we know, no accurate determination of inductance by this method has ever been published, and probably because of this requirement. Most alternating-current generators yield currents having harmonics of considerable magnitude, and the wave form, of course, varies according to the load. It is necessary, therefore, to determine the wave form of the particular current used in the experiment, in order to obtain the proper correction factor.

The Bureau of Standards possesses an alternating generator designed especially for testing purposes, which has a smooth cored armature and pole pieces so shaped as to give a nearly sine wave. The correction to be applied to the measured inductance due to a small departure from a sine form is correspondingly small, and we, therefore, believed that by using this machine it would be possible to measure inductance in this manner with a high order of accuracy, provided, of course, that small harmonics in the current were carefully determined and allowed for.

The method is illustrated in Fig. 2. The non-inductive resistance R (being an oil immersed resistance of manganin of relatively large carrying capacity) was placed in series with an inductive coil, having an inductance of about 1 henry, and a resistance of about 95 ohms. An alternating current from the generator passes from A to C through these resistances, in parallel with which is an electro-dynamometer D , which serves as a very sensitive voltmeter. An electrometer is joined to the point B and to a switch S , by means of which it can be connected to AB and to BC successively. By means of the rheostats R_1 and R_2 (Fig. 7), the first

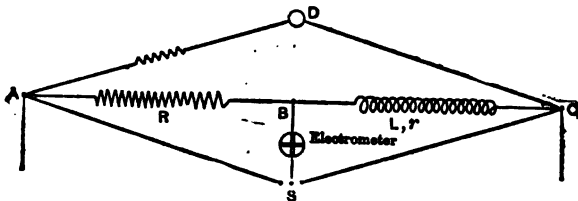

FIG. 2.

in series with the main current and the second in the field circuit of the alternator, the e.m.f. at the terminals AC is kept constant. The resistance R is now varied until the deflection of the electrometer is the same on AB as on BC .

$$\text{Then } R = \sqrt{r^2 + p^2 L^2}.$$

The frequency of the current is determined by means of a chronometer and chronograph. An electric contact being made for every 50 revolutions of the dynamo, a record is secured on the chronograph along with the second beats of the chronometer. Thus the frequency may be determined to a very high order of accuracy, provided the speed is maintained sufficiently constant. To do this a rotating commutator is directly connected to the alternator, and a Wheatstone bridge and condenser are joined up exactly as in the absolute measurement of capacity. When the bridge has been balanced at the desired speed, an assistant maintains the speed constant by means of a carbon rheostat R_3 , the criterion of constant speed being that the galvanometer continues to give zero deflection. That this condition of constant speed is sufficiently met will appear in the following pages.

The requirement of constant voltage is satisfied by having

the alternator directly coupled to its driving motor, running the latter from a storage battery having a very constant e.m.f., keeping the bearings and brushes in good order, and regulating the exciting current of the alternator by means of the manual adjustment of a carbon rheostat, so that the deflection of the volt-dynamometer D is maintained constant. The latter instrument, which gave a deflection proportional to the square of the voltage, was so arranged that a variation of one volt in 140 gave a change in the reading of about 25 mm. The readings of the electrometer were only made when the dynamometer deflection was within 0.2 mm of the selected mark, hence variations in the e.m.f. on AC were less than 1 part in 10,000 for all the separate readings. A differential electrometer might be used and so obviate the necessity of maintaining so constant a voltage. We have designed such an instrument and it has been constructed, but we have not yet had an opportunity to use it in this work.

3. POSSIBLE SOURCES OF ERROR.

The current flowing into the electrometer would cause an error in the result if the electrometer had a sufficiently large capacity, since it shunts first AB and then BC . This effect would be very small when the electrometer shunts AB , since its current would differ in phase by 90 deg. from that in AB ; but when in shunt with BC the electrometer current is nearly opposite in phase to the main current. The capacity of the electrometer is, however, so small that the current flowing into it from B is wholly inappreciable in comparison with the main current through ABC , which was usually nearly 0.1 ampere.

Any small inductance or capacity in the resistance R will produce no error, for its effect, if present, would be to slightly alter the phase of the e.m.f.; but could not alter the impedance to be measured to an appreciable extent. Thus if R is 1175 ohms and we suppose that there is sufficient inductance present to make the impedance a hundredth of 1 per cent greater or 1175.12, this would require at a frequency of 180 cycles an inductance of 15 millihenrys, or a capacity of 0.01 microfarad. A careful measurement shows that the capacity effect of this resistance exceeds the inductance effect but that the inductance effect is equivalent to a capacity of about 0.001 microfarad, and hence the error produced is wholly inappreciable.

The heating of the inductive coil causes a change in its resistance; in fact, its resistance serves as an excellent indication of its mean temperature. Any such change in the resistance, however, produces a very much smaller change in the impedance of the coil. Thus, if r changes from 95.0 to 95.5 ohms, the impedance will change only from (say) 1175.00 to 1175.04. As the resistance r is determined at frequent intervals during a series of measurements, the uncertainty of the impedance due to uncertainty in this resistance need never be as much as 1 part in 50,000. The change in the inductance due directly to changing temperature is, however, appreciable and needs to be taken into account very carefully. Foucault currents in the wire of the coil may cause the inductance to vary appreciably with the frequency, when the wire is relatively coarse, and the frequency is relatively high. To avoid any error due to this cause, the wire should be fine, or stranded if a low resistance is desired, and high frequencies avoided in the measurements.

The electrostatic capacity of the coil is also a source of error when the frequency is relatively high. Dolazalek⁵ has shown that at a frequency of 2500 p.s. the measured value of the inductance of a coil may be 3 or 4 per cent greater than its true value, due to this cause. The error is, however, proportional to the square of the frequency, so that at a frequency of 180 p.p.s. it amounts to only 1 or 2 parts in 10,000, and, by properly designing the coil, we believe that this correction could be reduced to perhaps 5 parts in 100,000, and its value determined experimentally with a fair degree of accuracy. This experimentally determined correction would include also any effect due to eddy currents, which effect is of opposite sign to the effect of capacity. Thus no corrections need to be applied to the result derived from the simple formula except those due to the electrostatic capacity of the coil and the wave form of the current. The former we have not attempted to determine experimentally; the latter we now proceed to ascertain.

4. CORRECTION FOR WAVE FORM.

The correction factor to be applied when using a single coil of negligible resistance has been given by H. F. Weber.⁶ Calling the

5. Dolazalek, *Ann. der Phys.* 1903, p. 1142.

6. *Wied. Ann.* 63, p. 366, 1897.

harmonic components of the e.m.f. at the terminals of the coil E_1, E_3, E_5 , etc., the correction factor for this case is

$$F = \sqrt{\frac{E_1^2 + \frac{1}{9} E_3^2 + \frac{1}{25} E_5^2 + \text{etc.}}{E_1^2 + E_3^2 + E_5^2 + \text{etc.}}}$$

This expression, however, is not applicable to the present case. To find the correction due to the wave form, when the resistances are not negligible, and when a resistance R is joined in series with an inductive coil, we remember that the square of the effective value of an alternating current is given by the following expression:

$$I^2 = I_1^2 + I_3^2 + I_5^2 + \text{etc.},$$

where I_1, I_3, I_5 , etc., are the values of the components of the current of which the relative frequencies are 1, 3, 5, etc.

The e.m.f. E_a on AB is made equal in the experiment to the e.m.f. E_b on BC . Therefore,

$$E_a^2 = E_b^2 \tag{1}$$

$$E_a^2 = R^2 (I_1^2 + I_3^2 + I_5^2 + \text{etc.}) \tag{2}$$

$$E_b^2 = E_1^2 + E_3^2 + E_5^2 + \text{etc.} = I_1^2 (\tau^2 + p^2 L^2) + I_3^2 (\tau^2 + 9p^2 L^2) + I_5^2 (\tau^2 + 25p^2 L^2) + \text{etc.}$$

$$= \tau^2 (I_1^2 + I_3^2 + I_5^2 + \text{etc.}) + p^2 L^2 (I_1^2 + 9I_3^2 + 25I_5^2 + \text{etc.})$$

where $p = 2\pi n$, and n is the frequency of the fundamental. Therefore, from (1),

$$(R^2 - \tau^2) (I_1^2 + I_3^2 + I_5^2 + \text{etc.}) = p^2 L^2 (I_1^2 + 9I_3^2 + 25I_5^2 + \text{etc.})$$

$$\text{Therefore, } p^2 L^2 = (R^2 - \tau^2) \left\{ \frac{I_1^2 + I_3^2 + I_5^2 + \text{etc.}}{I_1^2 + 9I_3^2 + 25I_5^2 + \text{etc.}} \right\}$$

$$\text{or, } L = \frac{1}{p} \sqrt{R^2 - \tau^2} \sqrt{\frac{I_1^2 + I_3^2 + I_5^2 + \text{etc.}}{I_1^2 + 9I_3^2 + 25I_5^2 + \text{etc.}}}$$

$$\text{or, } L = \frac{f}{p} \sqrt{R^2 - \tau^2}$$

where $f = \sqrt{\frac{I_1^2 + I_3^2 + I_5^2 + \text{etc.}}{I_1^2 + 9I_3^2 + 25I_5^2 + \text{etc.}}}$, and is the correction factor sought.

I will be seen from this expression for f that the presence of higher harmonics in the current causes the correction factor to depart from unity much more rapidly than the lower harmonics. For example, suppose that the equation of the current is

$$I = I_1 \sin (pt - \psi_1) + I_3 \sin (3pt - \psi_3) + I_5 \sin (5pt - \psi_5) + I_7 \sin (7pt - \psi_7) + I_9 \sin (9pt - \psi_9).$$

and that $I_1 = 100$

$$I_3 = 2$$

$$I_5 = 2$$

$$I_7 = 1$$

$$I_9 = 1.$$

$$\begin{aligned} \text{Then } f &= \sqrt{\frac{100^2 + 2^2 + 2^2 + 1^2 + 1^2}{100^2 + 9 \times 2^2 + 25 \times 2^2 + 49 \times 1^2 + 81 \times 1^2}} \\ &= \frac{10010}{10266} = 0.9875. \end{aligned}$$

Thus the correction amounts to 1.25 per cent.

If the harmonics had been more pronounced, and I_7 and I_9 were each 5 instead of 1, then would

$$\begin{aligned} f &= \sqrt{\frac{100^2 + 2^2 + 2^2 + 5^2 + 5^2}{100^2 + 9 \times 2^2 + 25 \times 2^2 + 49 \times 5^2 + 81 \times 5^2}} \\ &= \frac{10058}{13386} = 0.8668. \end{aligned}$$

The correction thus amounts to 13.32 per cent.

Prof. Weber found the correction for a certain Ganz alternator, with a greatly distorted wave, to amount to 6.8 per cent.

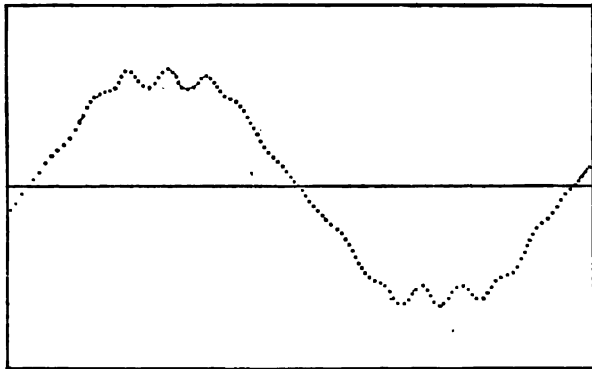

FIG. 3.

The e.m.f. shown in Fig. 3, due to a small Westinghouse alternator with slotted armature, has the following equation:

$$\begin{aligned} E &= 30.66 \sin(x - 0^\circ 56') + 0.80 \sin(3x - 6^\circ 17') - 1.65 \\ &\sin(5x - 14^\circ 22') + 0.40 \sin(9x + 7^\circ 50') + 1.11 \sin(13x - 30^\circ \\ &45') - 1.18 \sin(15x - 38^\circ 40'). \end{aligned}$$

The third, seventh, ninth, and eleventh harmonics are very small, the fifth, thirteenth, and fifteenth are relatively large. The correction factor for this curve is 0.9933, differing from unity by only 0.67 per cent and yet this is a larger correction than is desirable for precision measurements of inductance.

5. THE CURVES OF E.M.F. AND CURRENT.

The e.m.f. given by the alternator in our experiments and the current flowing through the circuit *ABC* under this impressed

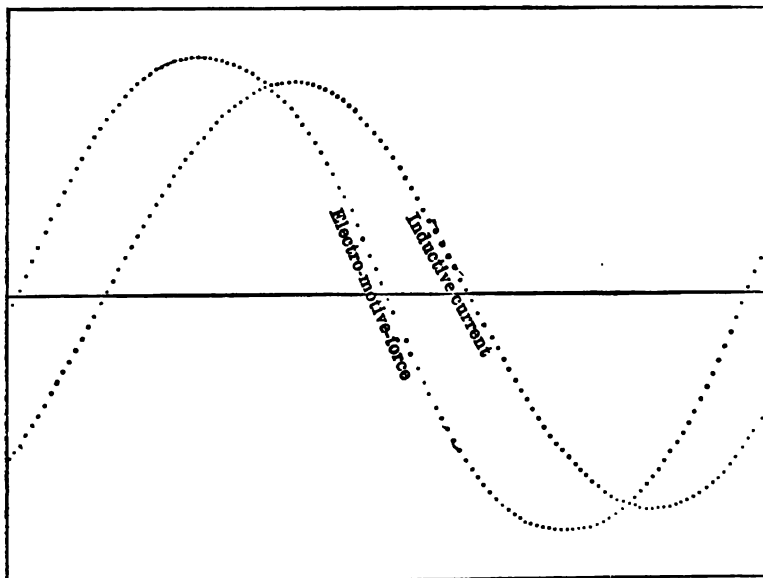

FIG. 4.

e.m.f. are shown in the curves of Fig. 4. These curves were drawn under the same conditions as those of the experiment. The third harmonic of the e.m.f. curve is in such phase as to slightly flatten the curve; this component being smaller in the current curve the latter is less flattened and more nearly a sine curve.

Although these curves were drawn with great care and are reasonably accurate, the analysis of the current curve did not give as good results as was desired. This was because the harmonics are so small that very slight errors in the curves produce relatively large errors in the harmonics.

All the odd harmonics were looked for up to the fifteenth and small values found in every case; above the seventh their average value was not more than a thousandth part of the fundamental and yet the values obtained from different sets of ordinates of the same curve varied considerably. This suggested that these harmonics were really absent in the curve and that the inevitable errors in drawing the curves gave rise to small residuals. The actual values of the small upper harmonics in question were, on the average, only one-twentieth of a mm measured on the plotted curve. Nevertheless, they made an appreciable error in the value of the correction factor sought, and hence it was desirable to eliminate all such residual errors.

The harmonics of the current are, however, readily computed from those of the e.m.f. which produces the current, and since in an inductive circuit the latter are larger than the former, the errors of the curve and of the analysis are divided down in the calculation, and a more accurate result may, therefore, be obtained.

Thus, for the third harmonic, the impedance is

$$\sqrt{(R+r)^2 + 9p^2 L^2} \text{ instead of } \sqrt{(R+r)^2 + p^2 L^2}$$

and, in a particular case, its numerical value is as follows:

$$r = 97.2$$

$$R = 1176.1$$

$$L = 1.0017$$

$$p = 2\pi n = 2\pi \times 186.23 = 1172.1$$

$$\text{Therefore, } Imp_1 = \sqrt{(1273.3)^2 + (1172.1)^2} = 1730.6$$

$$Imp_3 = \sqrt{(1273.3)^2 + 9(1172.1)^2} = 3739.7$$

$$Imp_5 = \sqrt{(1273.3)^2 + 25(1172.1)^2} = 5997.2$$

$$Imp_7 = \sqrt{(1273.3)^2 + 49(1172.1)^2} = 8302.8$$

$$\text{Hence, } \frac{Imp_3}{Imp_1} = 2.161 \quad \frac{Imp_5}{Imp_1} = 3.465 \quad \frac{Imp_7}{Imp_1} = 4.793.$$

These quotients show how much smaller, relatively, the third, fifth, and seventh harmonics are in the inductive current curve than in the e.m.f. curve. Therefore, the third, fifth, and seventh harmonics in the current curve may be found by dividing the corresponding harmonics in the e.m.f. curve by the numbers 2.16, 3.46, 4.80, respectively. Small errors due to the curve itself, or to the analysis, are thus divided by these factors and the values of the harmonics found are, therefore, more accurate and more consistent than if determined directly by analyzing the current curve.

This process may, indeed, be carried another step by placing a condenser in parallel with the circuit *ABC*, so that the alternating current flowing into it will be due to the same e.m.f. that causes the current in the circuit *ABC*. In the condenser current, however, the harmonics are magnified in proportion to their order, the seventh harmonic in the condenser current being seven times as great in proportion to the fundamental as in the e.m.f., and hence 7×4.798 or 33.58 times as great as in the current through *ABC*.

Fig. 5 shows the current in a condenser due to such an e.m.f. as that of Fig. 3, showing the prominence of the higher harmonics, especially those of 13 and 15 times the fundamental. In a similar manner we should expect that if there are any small harmonics of these frequencies in the current through the circuit *ABC*, they would be multiplied by 114 and 153 respectively in such a con-

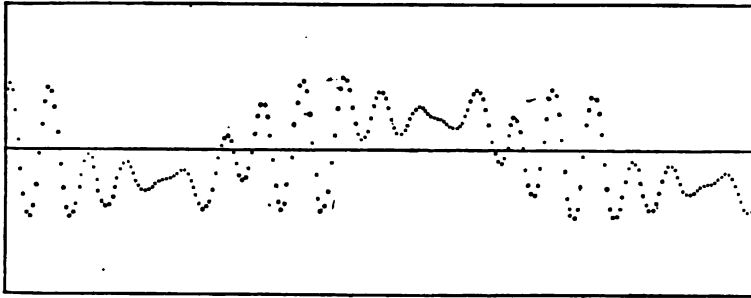

FIG. 5.

denser current in parallel with *ABC*. On the other hand, if no such harmonics are found in the condenser current, we may be sure that the small values found by analysis in the inductive current were, as we supposed, residual errors.

Fig. 6 gives two curves, I and II of e.m.f. and two curves, III and IV, of the condenser current. They were drawn under the same circumstances as prevailed during the measurement of the inductance, to be described later. The method of drawing the curves is illustrated in Fig. 7. The curve tracer is connected to the terminals of the small non-inductive resistances r_1 , r_2 , r_3 , successively, these terminals being joined to the potentiometer of the curve tracer, through the galvanometer on the one side and the contact maker on the other. Evidently a curve drawn with the connecting wires at the terminals of r_1 will represent the inductive current

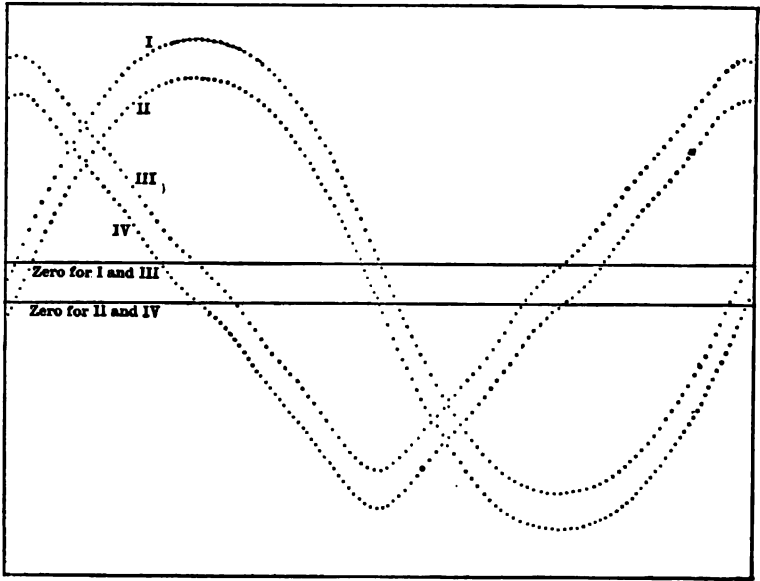

FIG. 6.

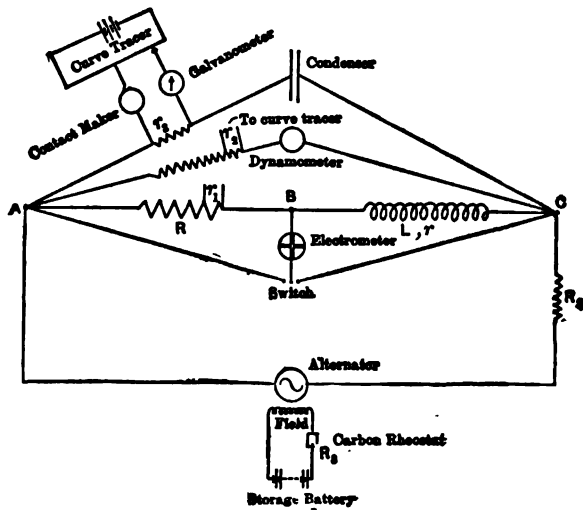

FIG. 7.

through ABC ; similarly, joining to r_2 , gives the e.m.f. on AC , and joining to r_3 , gives the condenser current. The curves of Fig. 6, which are far from being sine curves, but which evidently have no appreciable high harmonics, show the magnification of the harmonics in the condenser current. Since these condenser currents can be drawn with the same precision as the e.m.f. and current through the inductive circuit, it is evident that greater accuracy will be secured by analyzing the condenser current curves and calculating the correction factor f therefrom than by using the curves of the inductive current. However both pairs of curves, the e.m.f. and condenser current, have been analyzed and the correction factor f computed from both.

6. THE ANALYSIS OF THE CURVES.

The curves were drawn on the Rosa curve tracer, which is essentially an alternating-current potentiometer, arranged with a printing cylinder for automatically recording the curves. The spiral wire forming the potentiometer is not quite uniform in resistance; the cross-section paper on which the curves were printed was not ruled with as great accuracy as is necessary for the most precise work, and slight variations in the printed record were due to the backlash of the traveling carriage on the potentiometer. To eliminate all these errors at once the paper was replaced on the record cylinder of the curve tracer and the printing point was reset in the dots (one at a time) of the record. At the same time an ordinary direct-current potentiometer was joined to the center and traveling contact of the potentiometer wire of the curve tracer, a constant e.m.f. being maintained at the ends of the latter. Thus the values of the ordinates of the curves were measured, not from the paper record directly but electrically by the direct-current potentiometer, and the most important errors in the curves were thereby eliminated. These errors were, of course, all relatively small, but important enough to be avoided in the present work.

The curves of Fig. 6 were drawn after those of Fig. 4 and in virtue of a better adjustment of the brushes of the alternator the current was somewhat steadier and the curves a little more accurate. Hence only the results of the analysis of the curves of Fig. 6 will be given. The alternator has 12 poles, thus giving six complete periods in one revolution. The contact maker has three contact points 120 deg. apart, and thus makes a contact on every

other wave. The first curve of each pair of Fig. 4 was drawn while the contact maker turned, step by step, through 60 deg., and the second curve of each pair was drawn while the contact maker turned through another 60 deg. Thus one curve may be regarded as a composite made up of every other wave of the train superposed, and the second curve similarly consists of the alternate waves (not included in the first) superposed. We have analyzed both pairs of curves.

In each wave of current and e.m.f. 120 points are determined and printed, at distances of 3 deg. each in the wave, or 30 min. each in the generator, since one revolution gives six complete waves. We have used 15 points in each half wave in each analysis for the fundamental and harmonics, the mean value of the ordinates of the positive and negative half waves being taken in each case. Three separate sets of ordinates were in this way prepared for each curve, and the analysis carried through for each set to the thirteenth harmonic; that is, the harmonic having a frequency of 13 times the fundamental. The ordinates used in these analyses are given in Table I.

TABLE I.—SHOWING THE VALUES OF THE THREE SETS OF ORDINATES OF 15 EACH (AT ANGULAR INTERVALS OF 12 DEG.) FOR EACH OF THE FOUR CURVES ANALYZED.

The values of the ordinates are expressed in arbitrary units.

Curve I.			Curve II.		
E.m.f.			E.m.f.		
a	b	c	a	b	c
-4.72	-1.90	+0.06	+1.90	+4.28	+7.05
+6.61	+9.51	12.17	12.41	14.96	17.56
17.05	19.23	21.76	22.12	24.16	26.12
26.13	27.95	29.96	29.90	31.68	33.28
33.53	34.82	36.43	36.22	37.38	38.86
39.02	40.09	41.07	40.96	41.82	42.57
42.64	43.26	44.01	43.70	44.18	44.44
44.50	44.77	44.92	44.70	44.74	44.72
44.96	44.94	44.76	44.56	44.22	43.88
44.12	43.70	43.09	42.92	42.48	41.55
41.48	41.02	39.99	39.53	38.57	37.49
37.75	36.46	35.06	34.79	33.06	31.50
31.98	30.18	28.26	28.10	26.13	23.92
24.60	22.56	20.45	19.27	17.47	14.94
15.27	12.90	10.58	9.88	7.19	4.52
Curve III.			Curve IV.		
Condenser current.			Condenser current.		
a	b	c	a	b	c
+49.26	+49.49	+49.11	+49.06	+49.26	+48.87
46.62	45.08	43.46	46.60	45.15	43.41
39.62	37.91	36.21	39.85	37.70	36.04
32.46	30.96	29.20	32.61	31.00	29.14
25.88	24.11	22.02	25.86	24.22	22.42
17.80	16.10	13.64	17.96	16.06	13.86
9.46	7.37	5.54	9.69	7.78	5.98
+3.54	+1.21	+0.11	+2.98	+1.75	+0.67
-2.24	-3.44	-5.06	-1.76	-3.08	-4.76
-8.49	-10.31	-12.54	-8.08	-9.83	-11.63
-16.49	-18.30	-20.18	-16.10	-17.99	-19.73
-23.68	-25.28	-27.08	-23.33	-24.92	-26.67
-30.46	-32.24	-33.88	-30.16	-32.20	-33.95
-38.01	-39.96	-41.87	-37.50	-39.53	-41.33
-45.70	-46.94	-48.25	-45.08	-46.64	-47.68

The results of these analyses are given in Tables II and III. In the first part of each table the six values of the fundamental and of each harmonic are given in the proper columns, the first three as found for one curve, and the second group of three for the other. In the middle of the table are given the divisors by which we determine any harmonic of the current in the inductive circuit ABC from the harmonic of corresponding order in the e.m.f. or condenser

circuit in parallel with it. The calculation of these divisors has already been given (p. 214). The second part of the tables gives the values of the harmonics of the current curves so calculated.

TABLE II.—RESULTS OF ANALYSES OF THE TWO E.M.F. CURVES (I AND II) OF FIG. 6, AND CALCULATION OF COMPONENTS OF CURRENT IN THE INDUCTIVE CIRCUIT.

The values of E and I are expressed in arbitrary units.

Components of e.m.f. found by analysis.						
Fundamental= E_1 .	Harmonics.					
	E_3	E_5	E_7	E_9	E_{11}	E_{13}
Curve I { $a=46.880$	1.808	0.122	.127	.012	.031	.041
$b=46.888$	1.840	.186	.300	.051	.034	.075
$c=46.882$	1.989	.242	.223	.032	.062	.046
Curve II { $a=46.630$	1.889	.223	.154	.066	.022	.055
$b=46.608$	1.853	.206	.220	.086	.031	.031
$c=46.601$	1.883	.185	.241	.075	.041	.009
Divisors= 1	2.16	3.46	4.80	6.14	7.48	8.84
Calculated components of inductive current.						
Fundamental= I_1 .	Harmonics.					
	I_3	I_5	I_7	I_9	I_{11}	I_{13}
Curve I { $a=46.880$878	.085	.027	.002	.003	.005
$b=46.888$851	.064	.042	.003	.003	.003
$c=46.882$897	.070	.046	.013	.003	.005
Curve II { $a=46.630$874	.064	.032	.011	.003	.006
$b=46.608$848	.059	.046	.006	.004	.003
$c=46.601$848	.053	.050	.012	.005	.001

TABLE III.—RESULTS OF ANALYSES OF TWO CONDENSER CURRENTS, AND CALCULATION OF COMPONENTS OF CURRENT IN THE INDUCTIVE CIRCUIT.

The values of I are expressed in arbitrary units.

Components of condenser current curves found by analysis.							
Fundamental= I_1 .	Harmonics.						
	I_3	I_5	I_7	I_9	I_{11}	I_{13}	
Curve III {	42.374.....	5.119	.864	1.066	.101	.062	.090
	42.427.....	5.170	.900	1.188	.069	.107	.058
	42.368.....	5.110	.847	1.172	.106	.150	.082
Curve IV {	42.162.....	5.117	.809	1.067	.098	.066	.058
	42.160.....	5.122	.804	1.101	.185	.082	.185
	42.218.....	5.116	.809	1.145	.119	.125	.060
Divisors = 1.....	6.48	17.22	23.52	55.24	22.22	114.7	
Calculated components of inductive current.							
Fundamental= I_1 .	Harmonics.						
	I_3	I_5	I_7	I_9	I_{11}	I_{13}	
Curve III {	42.374.....	.790	.050	.081	.009	.001	.001
	42.427.....	.798	.052	.084	.001	.001	.000
	42.368.....	.788	.049	.085	.002	.002	.000
Curve IV {	42.162.....	.790	.047	.082	.002	.001	.001
	42.160.....	.782	.046	.082	.002	.000	.001
	42.218.....	.789	.047	.084	.002	.001	.001

There is a very noticeable drop in the values of the harmonics after the seventh; these small quantities are without doubt residual errors arising in drawing the curve and getting the values of the ordinates. When they are divided by the corresponding divisors to get the harmonics of the current they become insignificant, amounting on the average to about 1 part in 8000 of the fundamental for the e.m.f. curves, and 1 part in 40,000 of the fundamental for the condenser current, and thus having no appreciable effect whatever in the correction factor to be determined.

7. THE CALCULATION OF THE CORRECTION FACTOR f .

In the first part of Tables IV and V are given the values of the squares of the harmonics as found from the analyses of the 12 sets of ordinates of the four curves, and in the second part of the tables the same squares multiplied by 1, 9, 25, 49, the coefficients occurring in the expression for the correction factor f . In the last line the values of f are given.

TABLE IV.—CALCULATION OF CORRECTION FACTOR f FROM E.M.F. CURVES.

	Curve I.			Curve II.		
	a	b	c	a	b	c
$I_1^2 = \dots\dots$	2,197.6846	2,198.4475	2,197.8927	2,178.8750	2,173.8967	2,171.6776
$I_3^2 = \dots\dots$	0.7714	0.7250	0.8051	0.7840	0.7195	0.7195
$I_5^2 = \dots\dots$	0.0012	0.0023	0.0049	0.0041	0.0085	0.0028
$I_7^2 = \dots\dots$	0.0007	0.0017	0.0021	0.0010	0.0022	0.0025
Sum	2,198.4579	2,194.1771	2,198.8948	2,174.1441	2,173.0619	2,172.4024
$I_1^2 = \dots\dots$	2,197.6846	2,198.4475	2,197.8927	2,178.8750	2,173.8967	2,171.6776
9 $I_3^2 = \dots\dots$	6.9426	6.5250	7.2459	6.8760	6.4755	6.4755
25 $I_5^2 = \dots\dots$	0.0810	0.0720	0.1220	0.1025	0.0882	0.0712
49 $I_7^2 = \dots\dots$	0.0348	0.0853	0.1049	0.0490	0.1064	0.1285
Sum	2,204.6325	2,200.1298	2,205.8555	2,180.4025	2,179.0058	2,178.3478
$f \dots\dots\dots$	0.99859	0.99935	0.99849	0.99856	0.99863	0.99863
	Mean from curve I = .998577			Mean from curve II = 0.998607		

TABLE V.—CALCULATION OF CORRECTION FACTOR f FROM CONDENSER CURRENT CURVES.

	Curve III.			Curve IV.		
	a	b	c	a	b	c
$I_1^2 = \dots\dots$	1,795.6048	1,800.0458	1,797.1582	1,777.6218	1,777.4734	1,782.3466
$I_3^2 = \dots\dots$.6240	.6360	.6218	.6230	.6267	.6227
$I_5^2 = \dots\dots$.0024	.0027	.0024	.0022	.0022	.0022
$I_7^2 = \dots\dots$.0011	.0012	.0012	.0010	.0011	.0012
Sum	1,796.2323	1,800.6857	1,797.7781	1,778.2480	1,778.1034	1,782.9727
$I_1^2 = \dots\dots$	1,795.6048	1,800.0458	1,797.1582	1,777.6218	1,777.4734	1,782.3466
9 $I_3^2 = \dots\dots$	5.6160	5.7240	5.5917	5.6070	5.6408	5.6048
25 $I_5^2 = \dots\dots$.0807	.0675	.0598	.0550	.0540	.0545
49 $I_7^2 = \dots\dots$.0529	.0564	.0598	.0490	.0584	.0568
Sum	1,801.3344	1,805.8987	1,802.8645	1,788.8328	1,788.2201	1,788.0622
$f \dots\dots\dots$.99858	.99856	.99859	.99857	.99856	.99857
	Mean from curve III = 0.998577			Mean from curve IV = 0.998567		

The mean value of f found from Curve I differs from that found from Curve II by only 3 parts in 100,000, whereas the mean value of f , calculated from Curve III, differs from that of Curve IV by only 1 part in 100,000.

If we had omitted the small fifth and seventh harmonics in the calculation of f , using only the fundamental and the third harmonic, the result would have differed by only 3 parts in 100,000. This illustrates how unimportant are all the harmonics above the third. But the residual errors in the current curve determined directly, instead of indirectly through the condenser current are much greater. That the values obtained from different curves, and from different sets of ordinates in the same curve, agree so closely shows that the curve tracer gives a very accurate reproduction of the waves. It also proves that the six waves produced by one revolution of the twelve-pole alternator are very accurately the same, in as much as curves I and II were produced in different parts of the revolution and III and IV also.

SUMMARY OF VALUES OF f .

Mean value from Curve I of e.m.f.	= 0.998577
Mean value from Curve II of e.m.f.	= 0.998607
Mean value from both curves	= 0.998592 (a)
Mean Value from Curve III condenser current	= 0.998577
Mean value from Curve IV condenser current	= 0.998567
Mean value from both curves	= 0.998572 (b)
Weighted mean of (a) and (b), giving the result from the condenser current curves three times the weight of that of the e.m.f. curve	= 0.998577

In what follows we shall use 0.99858 as the most probable value.

Having now determined the correction factor to be applied to the values of L found by the use of these alternating currents, we may proceed to an account of the determination of the frequency.

8. MEASUREMENT OF FREQUENCY.

As already stated, the speed of the alternator was maintained as nearly constant as possible by hand control, using a carbon rheostat in the main circuit of the driving motor, the criterion of constant speed being that the deflection of a galvanometer, observed with a telescope and scale, should be kept zero. The galvanometer was joined to a Wheatstone bridge in which a condenser and a rotating commutator form one arm, precisely as though the object of the experiment was to determine the capacity of the condenser. This arrangement we have found to be a sensitive and satisfactory method of controlling the speed. The galvanometer is quick and nearly dead beat, and instantly shows any tendency of the motor to change its speed. Such tendency can be quickly checked by a slight change in the pressure on the carbon rheostat. Slight variations in speed above or below the normal cause corresponding deflections of the galvanometer to the right or left, and the operator balances these small deflections as nearly as possible during the period of the run.

To illustrate we give the determinations of frequency for the first four runs of the observations of May 28, which are fair samples of all the runs. Contact is made on the chronograph every 50 revolutions of the alternator, and as the latter is a 12-pole machine there are six waves in every revolution or 300 in every period of 50 revolutions. Ten contacts are read off at the beginning of each run and 10 at the end, and from these the mean interval for the whole number of periods is determined. The first two runs were divided into two parts each, and the frequency found for each, in order to see what the change was. After that the mean speed was found for the whole period of the run.

TABLE VI.—RUN 1.

First part.			Second part.		
Chronograph record.		Interval.	Chronograph record.		Interval.
Beginning.	End.		Beginning.	End.	
Min. Sec.	Min. Sec.	Sec.	Min. Sec.	Min. Sec.	Sec.
10 11.16	18 11.60	180.44	18 31.65	15 30.37	108.63
19.82	13.36	.44	33.33	31.94	.61
14.40	14.94	.45	35.02	33.60	.57
16.15	16.61	.46	36.67	35.28	.61
17.84	18.38	.44	38.33	36.95	.62
19.51	19.94	.43	40.02	38.62	.60
21.18	21.62	.44	41.68	30.29	.61
22.85	23.30	.45	43.34	31.96	.62
24.52	24.97	.45	45.02	33.63	.61
26.20	26.63	.43	46.69	35.30	.61
108 periods = 180.443. 108 × 300 = 32,400 waves. $n = \frac{32,400}{180.443} = 179.557.$			65 periods = 108.608. 65 × 300 = 19,500 waves. $n = \frac{19,500}{108.608} = 179.546.$		
Mean value of $n = 179.552.$					

TABLE VII.—RUN 2.

First part.			Second part.		
Chronograph record.		Interval.	Chronograph record.		Interval.
Beginning.	End.		Beginning.	End.	
Min. Sec.	Min. Sec.	Sec.	Min. Sec.	Min. Sec.	Sec.
18 2.29	33 9.59	247.30	24 53.34	29 59.09	305.75
3.97	11.36	.39	55.02	0.77	.75
5.64	12.93	.39	56.66	2.43	.77
7.32	14.61	.39	58.35	4.06	.71
8.99	16.27	.38	0.00	5.77	.77
10.66	17.95	.39	1.63	7.44	.76
12.34	19.63	.38	3.34	9.07	.73
14.02	21.30	.38	5.01	10.78	.77
15.67	22.98	.39	6.70	12.46	.76
17.34	24.64	.30	8.36	14.10	.74
148 periods = 247.269. 148 × 300 = 44,400 waves. $n = \frac{44,400}{247.269} = 179.542$			133 periods = 305.751. 133 × 300 = 54,900 waves. 54,900 $n = \frac{54,900}{305.751} = 179.55'$		
Mean value of $n = 179.550.$					

TABLE VIII.— RUNS 3 AND 4.

Run 3.					Run 4.				
Chronograph record.				Interval.	Chronograph record.				Interval.
Beginning.		End.			Beginning.		End.		
Min.	Sec.	Min.	Sec.	Sec.	Min.	Sec.	Min.	Sec.	Sec.
5	51.69	19	59.11	437.43	14	21.55	20	19.97	368.43
	53.37	18	0.81	.44		23.24		21.05	.41
	55.06		2.50	.44		24.99		22.34	.43
	56.75		4.18	.43		26.61		25.00	.39
	58.43		5.87	.44		28.28		26.71	.42
6	0.10		7.53	.43		29.94		28.39	.45
	1.78		9.23	.45		31.65		30.06	.41
	3.47		10.90	.43		33.33		31.74	.41
	5.16		12.60	.44		35.00		33.43	.43
	6.85		14.28	.43		36.70		35.11	.41
264 periods = 437.435 $264 \times 300 = 79,200$ waves. $n = \frac{79,200}{437.435} = 179.272$					218 periods = 368.418 $218 \times 300 = 65,400$ waves. $n = \frac{65,400}{368.418} = 177.524$				

The examples given, being the first runs of the first of the three days' work, are not as good as the best, but show that the frequency can be maintained very nearly constant. The first two runs were made with the same resistances in the Wheatstone bridge and the speed should, therefore, be the same. The mean frequencies found, 179.552 and 179.550, are practically identical. The resistance in the third arm of the bridge was now changed from 41,600 to 41,900, and the speed decreased until a balance was obtained. The frequencies for runs 3 and 4 were found to be, as shown in the Table, 178.272 and 178.284. To show how nearly the mean speed remains constant, while the bridge resistance is unaltered, Table IX is given.

TABLE IX.— FREQUENCIES OF ALTERNATING CURRENT IN 10 RUNS OF MAY 28.

R = resistance in the third arm of the auxiliary wheatstone bridge.

$R = 41,600$ ohms	Run 1, $n = 179.552$	Run 2, $n = 179.550$
$R = 41,900$ "	" 3, $n = 178.272$	" 4, $n = 178.284$
$R = 42,200$ "	" 5, $n = 177.009$	" 6, $n = 177.009$
$R = 42,250$ "	" 7, $n = 178.804$	" 8, $n = 176.793$
$R = 41,250$ "	" 9, $n = 181.063$	" 10, $n = 181.061$

9. THE DETERMINATION OF R .

Instead of attempting to make the e.m.f. on the non-inductive resistance AB exactly equal to that on BC , we adjusted AB to the nearest ohm and found the readings of the electrometer when the latter was joined first to AB , and then to BC , three pairs of readings being taken. If the resistance AB was found to be too small, it was then increased by 1 ohm and three pairs of readings of the electrometer again taken. By interpolation the value of the resistance was then found which would exactly balance the impedance of the inductive coil. As examples, the first three runs of June 2 are given.

TABLE X.—ELECTROMETER READINGS.

Run 1.	On AB .	On BC .	Differences $\times 100$	Mean.	Interpolated value of R .
Using LC					
$R=1,198$	14.92	14.765	-15.5	-15.7	1,198.92
	.92	.75	-16		
	.965	.77	-15.5		
$R=1,194$	14.85	14.885	+1.5	+1.9	
	.85	.86	+1.0		
Run 2: Using LF					
$R=1,178$	14.92	14.95	+3	+3.17	1,177.77
	.925	.955	+3		
	.965	.96	+3.5		
$R=1,177$	14.975	14.87	-10.5	-10.88	
	.975	.86	-11.5		
	.976	.87	-10.5		
Run 3. Using LC					
$R=1,194$	14.78	14.79	+1	+1.0	1,193.94
	14.77	.78	+1		
$R=1,198$	14.85	14.69	-16	-15.0	
	.85	.71	-14		
	.86	.70	-15		

A summary of the results of three sets of measurements taken on three separate days is given in Tables XI, XII, and XIII. In each of these sets measurements are made successively on an inductance standard by Carpentier of Paris, having a nominal value of 1 henry, and another by Franke & Company of Hanover, of the same nominal value. In the tables, the results for each coil are grouped together, the numbers of the runs indicating the order in which the measurements are made. The several columns give (1) the corrected values of the non-inductive resistance R , (2) the ohmic

resistance r of the inductive coil, (3) the frequency of the current, (4) the computed value of L from the formula (page 206) uncorrected for wave form, (5) the mean of these latter values, and finally (6) the mean after correction for wave form, using $f=0.99858$. The corrected values of the resistances were found by means of a carefully calibrated bridge, and were redetermined each day. D is the average deviation of the individual determinations from the mean of them all.

TABLE XI.—RESULTS OF MAY 28.

LC	1	2	3	4	5	6
	R	r	n	L_1 uncorrected for wave form.	L_1 mean of.	L
Run 1.....	1,149.98	97.6	179.551	1.01597
" 4.....	1,141.90	97.75	178.284	1.01564
" 5.....	1,133.98	97.9	177.009	1.01575	1.01573	1.01423
" 8.....	1,132.69	98.05	178.788	1.01586	($D=7.2$ in 100,000)
" 9.....	1,150.76	98.2	181.088	1.01596
LF						
Run 2.....	1,194.01	97.4	179.550	1.00144
" 3.....	1,128.93	97.6	178.272	1.00140
" 6.....	1,118.19	97.7	177.009	1.00138	1.00144	1.00002
" 7.....	1,116.68	97.8	178.804	1.00135	($D=5.2$ in 100,000)
" 10.....	1,148.62	97.9	181.081	1.00145

TABLE XII.—RESULTS OF MAY 31.

LC	1	2	3	4	5	6
	R	r	n	L_1 uncorrected for wave form.	L_1 mean of.	L
Run 1.....	1,194.42	97.0	188.550	1.01561
" 4.....	1,198.44	97.3	186.437	1.01540
" 5.....	1,192.26	97.5	186.220	1.01560	1.01560	$L=1.01416$
" 8.....	1,192.54	97.7	186.226	1.01577	($D=9.5$ in 100,000)
LF						
Run 2.....	1,173.16	96.9	188.561	1.00168
" 3.....	1,177.10	97.1	186.440	1.00141
" 6.....	1,170.12	97.2	186.224	1.00166	1.00160	$L=1.00018$
" 7.....	1,170.16	97.3	186.227	1.00168	($D=10.2$ in 100,000)

TABLE XIII.—RESULTS OF JUNE 2.

LO	1	2	3	4	5	6
	R	r	s	L_1 uncorrected for wave form.	L_1 mean of.	L
Run 1.....	1,194.38	96.9	186.579	1.01541
" 2.....	1,194.35	96.9	186.584	1.01541
" 5.....	1,194.67	96.9	186.621	1.01549	1.01549	1.01598
" 8.....	1,183.92	96.9	184.721	1.01539
" 10.....	1,183.96	96.9	184.738	1.01541	(D=2.6 in 100,000)
" 11.....	687.53	96.9	106.704	1.01525
" 13.....	687.60	96.9	106.704	1.01536	1.01530
LF						
Run 2.....	1,178.18	96.7	186.578	1.00162
" 4.....	1,178.56	96.7	186.619	1.00173
" 6.....	1,178.56	96.7	186.621	1.00171	1.00173	1.00081
" 7.....	1,167.11	96.7	184.778	1.00158
" 9.....	1,167.07	96.7	184.784	1.00174	(D=4.8 in 100,000)
" 12.....	678.25	96.7	101.698	1.00142
" 14.....	678.35	96.7	106.698	1.00153	1.00147

TABLE XIV.—SUMMARY OF RESULTS.

	LC	LF	Ratio of $\frac{LC}{LF}$
May 26.....	1.01498	1.00608	1.01496
May 31.....	1.01416	1.00018	1.01398
June 2.....	1.01398	1.00081	1.01397

10. DISCUSSION OF THE RESULTS.

The results of June 2 are somewhat more uniform than those of the two preceding days, due largely to the fact that the electrometer was adjusted to a greater sensibility and readings were consequently more accurate. The average deviation of the separate determinations from the mean is less than 4 parts in 100,000 in this set.

The two determinations of L at lower frequency on June 2 are subject to a correction for wave form which was not separately determined, and probably the capacity correction which would be smaller for the lower frequency, accounts for part of the difference. We mean to resume the experiments and make a longer series of measurements at other frequencies.

Table XIV shows a progressive change in the values of LC and LF , but in opposite directions; in both cases the change between

May 28 and June 2 is about 3 parts in 10,000. Referring to Tables XI, XII, and XIII, in which the values of r , the resistances of the coils, are given, it will be observed that the resistances happen to be almost exactly equal for the two coils, and that both were lower on May 31 than on May 28, and still lower June 2, the total difference being almost exactly 1 ohm for each coil. This corresponds to about $2^{\circ}.5C.$, and is due to the lower temperature of the laboratory on the later days. We were surprised to find evidence of a positive temperature coefficient in one coil and a negative coefficient in the other, and, therefore, made some direct comparisons of the two coils with each other with a view to testing this point. LC being maintained at a constant temperature of about $21^{\circ}.5C$, LF was cooled about $3^{\circ}.0$ by leaving it in a cooler room over night. The two coils being balanced against each other, with a variable inductance included with the smaller, LF , was warmed in an inclosed space and its inductance was observed to *decrease* about 3 parts in 10,000. On another day LF was kept constant and LC heated in a similar manner. The result was an *increase* in the value of LC . LF being again heated while LC remained constant, its value *decreased* with respect to LC . An exact measure of the change of temperature was not obtained, and hence no definite value of the temperature coefficient was found.

A possible explanation of the opposite sign of the temperature coefficients suggested itself when we removed the covering of LF . This coil is wound on a spool of serpentine and the wire is imbedded in paraffin. The formula for the inductance of such a coil is

$$L = 4\pi n^2 a \left(\log \frac{8a}{R} - 2 \right)$$

where a is the mean radius of the coil and R is the geometric mean distance of the wires in the cross-section of the coil. When the paraffin (which has a temperature coefficient many times larger than copper) expands it tends to increase the geometric mean distance of the wires and so decrease L , and this effect may be greater than the increase due to the expansion of the copper, which increases a . The other coil, however, is wound on a spool of mahogany with dry, silk-covered wire, and there is no such tendency to increase R . Whether part of the observed increase of LC with increase of temperature is due to the spool itself we do not know.

It is evident that we must either keep these coils continuously at a constant temperature when measuring their inductances, or else get some new ones not subject to such large temperature coefficients.

Whether this is possible we do not know, but hope soon to make some trials in this direction and also to study more carefully the magnitude of the temperature coefficients of these coils and their causes.

This method of measuring inductance is capable of yielding somewhat better results than those given above, when all possible refinements are introduced. It seems to us desirable to measure in this way some carefully constructed inductance standards whose values can be computed from their dimensions. The determination of such pairs of values of L would amount to an absolute determination of the international ohm.

We are indebted to Mr. C. E. Reid for assistance in making some of the observations recorded in this paper, and to Dr. N. E. Dorsey for assistance in analyzing the curves.

DISCUSSION.

CHAIRMAN ARRHENIUS: The paper is now open to discussion.

DOCTOR DRYSDALE: I should like to take the opportunity of making a few remarks on this very valuable paper by Doctor Rosa and Mr. Grover, as the subject of inductance measurement has always been of great interest to me, owing to my having been in charge some ten years ago of the standardising of self-induction apparatus for Messrs. Nalder Bros. & Co., who at that time were probably the only makers of such apparatus in the world. At that time the standardisation of inductance coils was a matter of some difficulty, and I should like to congratulate the authors of this paper on the extreme accuracy they have obtained by the alternate-current method, a method which I was unable to make use of owing to lack of facilities for wave-form determination. The methods then open to me for standardisation were comparison with a condenser, or with a calculated standard coil, and the absolute method with or without a secohmmeter. The latter method does not lend itself to great accuracy; so that I had recourse to both of the former. The condenser, in conjunction with a secohmmeter, was found to give remarkably consistent results, and would doubtless have been very satisfactory but for the difficulty in ascertaining the exact value of the condenser on account of absorption. The difference in the capacity of an ordinary mica condenser for slow and for rapid charge and discharge was found to be always of the order of 1 per cent, and at that time it was difficult to ascertain the capacity under the conditions it was used. On this account I had two coils made up of carefully determined dimensions, and calculated the inductance of each of the coils and the coefficient of mutual induction between them. On comparing the values of the inductances obtained by the condenser with those of the coils, a discrepancy of about 0.3 per cent was observed, and it was impossible to reconcile this discrepancy. I mention these points, as condenser methods are frequently advocated and used for inductance measurement and as showing what a great advance in accuracy Doctor Rosa has made by his modification of

the alternate-current method correcting for the wave form, which he has been able to accomplish with the aid of his very beautiful curve tracer. The results which the authors have obtained by this method are of such remarkable accuracy that if one had not known of the source of them one would have felt inclined to think that these close agreements were the result of coincidence, and of fictitious rather than real accuracy. The idea of being able to actually detect the temperature variation of inductance, depending as it does on two opposing coefficients of expansion, is most extraordinary, and nothing but the extreme consistency of the variations, as indicated by the results, would have justified this assumption.

It is, however, easy to check the authors' results on the temperature variation of inductance approximately by simple calculation. The well-known approximate formula of Maxwell for the inductance of a circular coil is

$$L = 4\pi n^2 a \left(\log \frac{8a}{R} - 2 \right)$$

where a is the radius of the coil, n the number of turns, and R the logarithmic mean distance between the parts of the coil. The effect of expansion is of course to alter a and R , and we have

$$\frac{dL}{dt} = 4\pi n^2 a \left\{ \left(\log \frac{8a}{R} - 1 \right) \frac{1}{a} \frac{da}{dt} - \frac{1}{R} \frac{dR}{dt} \right\}$$

and denoting the coefficients of expansion of a and of R by α and β respectively

$$\frac{dL}{dt} = 4\pi n^2 a \left\{ \left(\log \frac{8a}{R} - 1 \right) \alpha - \beta \right\}$$

Hence, if $\frac{\beta}{\alpha} = \log \frac{8a}{R} - 1$ there is no temperature variation of

inductance, while if β is smaller than that given by this relation the temperature coefficient of inductance will be positive, and if greater, negative. This confirms the possibility of having coils with both positive and negative coefficients, as the authors have found. But if the coils have been designed for maximum inductance according to Maxwell's rules, the value of

$$\log \frac{8a}{R} = 3.5 \text{ hence } \frac{dL}{dt} = 4\pi n^2 a (2.5 \alpha - \beta).$$

Consequently the lateral expansion between the turns must be $2\frac{1}{2}$ times the radial expansion for compensation, which may easily be the case, as the insulating material, such as paraffin wax, may have a much higher expansion than that of the coil.

This simple investigation is of value in that it tends to confirm the authors' conclusions, and at the same time shows us how to design a coil of no temperature variation. It also serves to make us realize even more forcibly the extreme sensitiveness of the authors' method of determination, when we consider that by its aid they can determine the difference between the two coefficients of expansion. I have not the authors' figures available for the purpose of comparing the variations they have

found with those which would be probable from the above formula, but have no doubt that they would substantially agree.

In conclusion, I should again like to heartily congratulate the authors on the perfection of their method and results. I certainly do not think that any method will be found to surpass, or even equal it, in accuracy, and I hope it will be adopted as the standard method.

CHAIRMAN ARRHENIUS: Is there any one else who wishes to make remarks? If not, we will proceed with Prof. J. J. Thomson's paper, which will be read by Professor Rutherford.

PROFESSOR RUTHERFORD: This is a paper by Prof. J. J. Thomson, entitled "The Relation Between Mass and Weight For Radium."

THE RELATION BETWEEN MASS AND WEIGHT FOR RADIUM.

BY PROF. J. J. THOMSON, M. A., F. R. S., *Cambridge University.*

If we regard an atom as consisting of a large number of corpuscles, i. e., exceedingly minute negatively electrified bodies, moving about in a sphere of positive electricity, then, on account of the exceedingly small size of the corpuscles, the "electrical mass" of the atom will be practically that of the corpuscles within it.

Now the electrical mass of a corpuscle suffers an appreciable increase when the velocity of the corpuscle becomes comparable with that of light, so that if we have a number of corpuscles moving with very great velocity, their mass would be greater than that of the same number of corpuscles moving more slowly.

Thus if we have two atoms, in one of which the corpuscles are moving slowly, while in the other they are moving with great rapidity, the ratio of the masses will not be the same as the ratio of the number of corpuscles.

The ratio of the masses of two atoms may thus involve the question of their velocity. It seems, therefore, desirable to investigate whether the ratio of the weights of the atom would vary in the same way, i. e., whether the ratio of mass to weight would be the same in bodies in which the corpuscles are in very rapid movement, as it is in bodies in which the movement is less vigorous.

Now the phenomena connected with radium, such as the emission of corpuscles with velocities approaching that of light, the emission of the α particles, mark it out as the substance in which the velocities of the corpuscles are most likely to have high values, and it seemed interesting, therefore, to try whether the relation between mass and weight is the same for radium as for other substances.

The most accurate way of determining the relation between mass and weight is by means of the pendulum. The experiment described in this paper is that of determining the time of swing of a radium pendulum.

THE PENDULUM.

The bob of the pendulum consisted of 33.5 milligrammes of radium bromide inclosed in an envelope of thin aluminum foil, the whole weighing 35 milligrammes; the length of the bob was 13 mm, the greatest breadth 3 mm; the suspension was a very fine silk fibre, the length of which was about 80 cm in one experiment, 35 in another. The damping of the pendulum, when vibrating in air at atmospheric pressure, was, on account of the small mass, too great to allow of the time of swing being accurately determined.

The pendulum was, therefore, suspended in a cylindrical glass vessel which was fused on to a mercury pump and the air exhausted until the pressure was exceedingly low; it was found possible, by reducing the pressure, to get the pendulum to make more than 200 complete vibrations before the amplitude became too small to allow the requisite observations for the timing to be made.

To prevent disturbance from the electrification of the bob by the emission of the negatively charged β rays, the fibre supporting it was made conducting by slightly damping it with glycerine; it was then metallically connected with the earth. The inside of the glass vessel in which the pendulum swung was lined with copper gauze, connected with the earth.

METHOD OF TIMING THE PENDULUM.

The pendulum of a standard clock closed an electric circuit each time it passed through the vertical position; this circuit passed through a relay which broke the primary circuit of an induction coil whenever a current passed through the relay.

The breaking of the current in the primary caused a spark to pass between the terminals of the secondary of the induction coil.

The light from this spark was focussed by a cylindrical lens on the fibre suspending the bob of the pendulum, which was thus illuminated every second; the fibre was observed through a microscope provided with a micrometer scale.

The method used for timing the pendulum was the modification of the method of coincidences introduced by Professor Poynting. This method was used and described by Mr. F. Horton in his paper on the "Variation of the Rigidity of Metals with Temperature" (*Phil. Trans.* 1904). The principle of the method is as follows: Suppose we find that n swings of the radium pendulum take nearly the same time as m swings of the seconds pendulum;

suppose that the string of the radium pendulum when illuminated by the flash due to the seconds pendulum is vertical at any instant; observe the position after m seconds; if the ratio of the periods is not exactly n/m the fibre will not be quite vertical. Take the reading on the scale in the telescope, and take the successive readings after every m seconds until there is again a coincidence, the fibre being again vertical. (In general to get the period of coincidence we have to interpolate between two values on opposite sides of the vertical.)

Suppose that the coincidence occurs after r periods of m seconds each; then if T' is the time of swing of the radium pendulum, T that of the seconds pendulum, we have

$$(rm \pm 1) T = rnT'$$

$$\text{or } \frac{T'}{T} = \frac{m}{n} \pm \frac{1}{rn}$$

In making these experiments I am greatly indebted to Mr. Horton, who has had great experience in the use of this method, and who took the measurements necessary to determine the time of swing.

In order to eliminate the uncertainty as to the position of the center of gravity of the radium bob AB , the time of swing of the pendulum was determined (1) with the end A at the top and (2) with the end B .

The length of the pendulum was measured *in vacuo*; it was found to lengthen when air was admitted, which I attributed to the absorption of water by the glycerine with which the suspending fibre was smeared.

The equations used to determine the ratio of weight to mass for the radium are as follow:

Let m be the mass of the radium bob; k^2 the square of the radius of gyration of the bob about an axis through its center of gravity at right angles to the plane of oscillation of the pendulum; $2d$ the length of the bob; $d+x$ the distance of its center of gravity from the end A ; l the length of the fibre supporting the bob; m' the mass of the fibre; g_r the ratio of weight to mass for radium; T the time of swing of the pendulum when the end A is uppermost. Then we have

$$m(k^2 + (l + d + x)^2) + m' \frac{l^2}{3} = (mg_r(l + d + x) + m'g \frac{l}{2}) \frac{T^2}{4\pi^2}$$

When B is uppermost, and T' the time of swing, l' the length of the fibre, we have

$$m(k^2 + (l' + d - x)^2) + m' \frac{l'^2}{3} = (mg_r (l' + d - x) + m'g \frac{l'}{2}) \frac{T_1^2}{4\pi^2}$$

As a first approximation these equations give

$$l + l' + 2d = \frac{g_r}{4\pi^2} (T^2 + T_1^2).$$

We must now consider the corrections to be applied to this simple formula. The measurements of the time of swing given below show that for the longer pendulum these can be relied upon to 1 part in 10,000; and in the case of the shorter, to 1 part in 6000; as the expression of g_r involves the square of the time of swing, the accuracy with which g_r is measured will be to 1 part in 5000 for the longer pendulum and to 1 part in 3000 for the shorter.

We may, therefore, neglect in the case of the longer pendulum corrections not amounting to 1 part in 5000, and in the case of the shorter those not amounting to 1 part in 3000.

CORRECTIONS FOR MOMENT OF INERTIA OF THE BOB.

In the formula given on page 236 we have neglected k^2 in comparison with $(l+d-x)^2$. Now the length of the bob was 1.3 cm and its greatest breadth .3 cm; hence the moment of inertia will be less than that of a cylinder 1.3 cm long and .3 cm in diameter; k^2 , therefore, will be less than .1464 cm².

Now for the long pendulum $l + d - x$ was about 80 cm; hence $(l+d-x)^2$ is about 6400cm², so that k^2 is only about 1/40,000 of $(l + d - x)^2$ and may, therefore, be neglected.

In the case of the shorter pendulum, $l + d - x$ was about 34; hence $(l + d - x)^2$ is about 1156, so that in this case k^2 is only about 1/8000 of $(l + d - x)^2$ and may be neglected.

CORRECTION FOR SUSPENDING FIBRE.

From the equation

$$m(k^2 + (l + d + x)^2) + \frac{m' l^2}{3} = (mg_r (l + d + x) + m'g \frac{l}{2}) \frac{T^2}{4\pi^2}$$

we get, taking the terms depending on the fibre to the left-hand side

$$m(k^2 + (l + d + x)^2) + m' l^2 \left(\frac{1}{3} - \frac{1}{2} \right) = mg_r (l + d + x) \frac{T^2}{4\pi^2}$$

approximately, since the observations show that

$$l = g \frac{T^2}{4\pi^2}$$

approximately. Hence neglecting l^2 we have

$$m(l+d+x)^2 - m' \frac{l^2}{6} = mg_r(l+d+x) \frac{T^2}{4\pi^2}$$

In the small term $m' \frac{l^2}{6}$ we may put $l+d-x$ for l and we get

$$\left(1 - \frac{m'}{6m}\right)(l+d+x) = g_r \frac{T^2}{4\pi^2}$$

Hence we see that to correct for the fibre we must multiply the uncorrected value of g_r by $\left(1 - \frac{m'}{6m}\right)$

Now $m = 0.035$ gm

$m' = .00032$ gm for the longer fibre

hence $m'/6m = .0015$.

For the shorter fibre which was rather thicker than the longer $m' = .00035$ gm

hence $m'/6m = .00166$

The following are the results of the experiments:

Long pendulum, end *A* of bob at top.

Length 79.6752	} mean 79.6754
79.6755	
79.6754	

$d = 1.310$ mean of three readings.

Time of swing. Coincidence period 11:6

n (number of periods)	T	Diff. from mean.
-------------------------	---	------------------

$$\left(\frac{11}{6} - \frac{1}{6n}\right)$$

4.152	1.79319	.00025
4.097	1.79265	.00029
4.136	1.79303	.00009
4.126	1.79294	.00000
4.123	1.79291	.00003
4.120	1.79288	.00006
4.128	1.79296	.00002

mean 1.79294 secs.

Average difference from mean0001

Long pendulum, end *A* at bottom,

Length l' 79.950
 79.9425
 79.945
 79.935

Mean.... = 79.943 $d = 1.307$ mean of four readings.

Time of swing 11 : 6 period

n	T'	Diff. from mean
	$\left(\frac{11}{6} - \frac{1}{6n}\right)$	
5.333	1.80208	.00010
5.310	1.80194	.00004
5.330	1.80206	.00008
5.276	1.80174	.00024
5.272	1.80172	.00026
5.380	1.80235	.00037

Mean time of swing 1.80198 secs

Average difference from mean..... .00017

From the approximate formula

$$l + l' + 2d = \frac{g_r}{4\pi^2} (T^2 + T'^2)$$

we get

$$g_r = 983.17$$

Correcting this for the mass of the suspending fibre we get

$$g_r = 981.6$$

The value of gravity at Cambridge calculated by Helmholtz's formula is

$$g = 981.25$$

Hence the difference between g and the ratio of weight to mass for radium is not more than 35 parts in 90,000; this difference was within that due to errors of experiment.

Experiment with Short Pendulums.

End A of bob at top

length l 33.5695
 33.5790
 33.5725

mean.... = 33.5736 cm d (mean of 3) = 1.3132

Time of Swing

Coincidence periods 20 : 17

n	$T = \left(\frac{20}{17} - \frac{1}{17n} \right)$
7.044	1.16812
7.136	1.16823
7.063	1.16814
7.106	1.16819
7.094	1.16818
7.074	1.16816
7.095	1.16818
	<hr/>
Mean	1.16817
	<hr/> <hr/>

Average difference from mean .000127

End A of bob at bottom

length l'	33.665
	33.669
	33.665
	<hr/>

mean.... = 33.666 d (mean of 3) = 1.330 cm*Time of Swing*

Coincidence periods 6 : 5

n	$T = \left(\frac{6}{5} - \frac{1}{5n} \right)$
8.934	1.17761
8.830	1.7735
9.006	1.17779
8.789	1.17724
8.829	1.17735
8.969	1.17770
8.814	1.17731
8.933	1.17761
8.811	1.17730
	<hr/>
mean	1.17747

Average difference from mean .00018

From the approximate formula (see page 237).
we get

$$g_r = 983.7$$

Correcting for the mass of the fibre

$$g_r = 982.06$$

This is within 1 part in 1500 of the value of g for ordinary matter. I think the measurements with the long pendulum are a little more accurate than those with the short. These results show that at any rate to an approximation of 1 in some thousands the ratio of mass to weight for radium has its normal value.

Hence we conclude that if the view of the structure of the atom given at the beginning of the paper is true, either the ratio of mass to weight must remain constant, even when the mass owing to the great velocity of the particles is variable, or what seems *a priori* more probable, that the number of corpuscles which possess a velocity approaching that of the β rays is an exceedingly small fraction of the whole number of corpuscles.

It should, however, be remembered that the effect of velocity on the mass of a corpuscle is influenced by the presence of other corpuscles in its neighborhood; thus for example if we have a number of corpuscles placed at equal intervals along the circumference of a circle, the corpuscles all rotating round the center of the circle, the effect of velocity on the mass of each corpuscle will be less than the effect on the mass of an isolated corpuscle.

If the corpuscles followed each other so closely round the circle that the electrical field was the same as that of a uniformly electrified ring, the mass of the corpuscles would be entirely unaffected by their velocity; for this to be the case, however, the distance between the neighboring corpuscles would have to be comparable with the diameter of a corpuscle.

DISCUSSION.

PROFESSOR RUTHERFORD: I think the paper of Professor Thomson is one of very great interest. Since you have corpuscles in radium sent out at the velocity of 95 per cent of that of light, and at the same time you have other particles sent out at the velocity of 10 per cent of that of light, it seems this might make a difference in weight. It might give negative results. The results of Professor Thomson show this is the case. It is important to have definitely settled that in radium the ratio of mass to weight is not different from any ordinary substance.

CHAIRMAN ARRHENIUS: Is there anyone else who wishes to make any remarks? If not, we will ask Doctor Guthe for his paper.

Doctor Guthe read the following paper on "Coherer Action: "

COHERER ACTION.

BY DR. K. E. GUTHE, *National Bureau of Standards.*

1. While the peculiar electrical behavior of loose contacts has only in recent years become an object of general interest to physicists, we find here and there in the literature accounts of experiments on this subject, sporadic forerunners of the enormous number of investigations which followed the invention of wireless telegraphy with the application of the coherer as a receiver for electric waves.

In fact, the type of instrument best known by the name of coherer, i. e., a glass tube filled with metal filings, was studied as early as 1835 by Munk af Rosenschoeld, who clearly describes the permanent increase of the electrical conductivity of filings of tin, pieces of carbon and other conductors, by the discharge of a Leyden jar, and who showed that a shaking of the tube would restore the original high resistance. The formation of a good electrical contact in a finely divided mass of black lead or charcoal, by a sufficiently high voltage, was observed by Varley in 1870. Fifteen years later Calzecchi-Onesti designed a filing tube and clearly recognized its peculiar action. After having noticed the lowering of resistance due to the opening of a battery in the circuit or to discharges from a Holtz machine he went as far as to connect the tube in series with the secondary of an induction coil producing the coherer effect by interruptions of the primary.

In 1890 Branly published his first investigation in which he demonstrated that the filing tube, reinvented by him, will respond to sparks produced at a distance from it — an investigation which formed the beginning of a systematic study of coherer action.

Similar results have also been observed with conductors forming a so-called single contact. Hughes clearly grasped as early as 1879 the importance of the coherer action upon a microphonic contact as a means of signalling through space, but was prevented by circumstances from following up his important discovery. Schuster and Bidwell had probably to do with similar phenomena without, however, recognizing their value.

In 1889 Lodge was led from a study of Boltzmann's form of wave

detector to the construction of the double knob coherer and employed it in his syntonic jar experiment. After becoming acquainted with Branly's tube he immediately recognized the similarity between the two and gave the name "coherers" to all instruments which showed the striking decrease of resistance due to electrical action, a name more appropriate according to our present knowledge of the subject than "radioconductor" or the German "fritter."

2. The types of coherer used in wireless telegraphy are quite varied, having a single contact or only a few or a large number, as in the filing tube.¹ The tastes of the numerous investigators differ just as much, and the results are therefore frequently difficult to interpret. The greatest diversity of opinion exists as to the best material for the instrument. It has been found that the particles do not need to be metallic, but may be carbon, lead peroxide, cupric sulphide, etc. Also mercury globules will form good coherers. A wide choice is left as to the dielectric, which is usually a gas, but may be liquid or even solid; or it may be practically absent, since filings in vacuo also show the characteristic coherer effect, i. e., the lowering of resistance due to an electrical influence produced either by electric waves or by a battery connected to the terminals of the instrument.

3. A great many different explanations have been proposed for "coherer action." The one which seems to have found the largest number of adherents is that of Lodge who believes that the metallic surfaces are originally separated by some badly conducting film which may be compressed and partly be pushed aside by electrostatic attraction. The film finally bursts "with what we must be allowed to call a spark, though an infinitely small one," and the metal particles are welded together.

Though Lodge is very careful in his statement, a large number of investigators have tried to prove the existence of sparks by direct observation under the microscope, but in all these cases the excitation was far beyond that which is necessary to produce a distinct coherer effect; while Hårdén, Muraoka and Tamaru have shown that frequently in spite of strong sparking no cohesion takes place, unless the gap between the particles is made smaller than 0.001 cm.

Further, it is not surprising that in cases of strong excitation a motion of the small particles has been observed, as by van Gulick,

1. See Collins, *The Engin. Mag.*, vol. 27, p. 360, 1904.

Appleyard, Hanchett and Semenov; consequently it has been suggested that this motion plays an important rôle. Eccles considers orientation of the particles as the first and most important step in coherer action. Tissot's magnetic coherer shows that orientation due to a magnetic force improves the sensitiveness, though he has never observed an orientation of the particles while coherence took place.

Auerbach, who observed the influence of sound waves upon the resistance of a coherer, believes that pulsations may be set up in the particles by the electric oscillations and thus the resistance be reduced by "mechanical" action, a view also shared by Drago; but many observers show beyond doubt that a lowering of resistance takes place even if the particles are imbedded in solid dielectrics (Branly, Arons, Fromme). Looseness of the particles in fact often facilitates an increase of resistance under strong electrical influence as Blanc has shown. Branly's experiments with large metal disks as well as those with single contact coherers are also strongly against such an interpretation. Branly even advises to press the filings together in order to obtain the best results.

Finally, as far as the welding is concerned, it must be admitted that after cohesion has set in, the particles may form chains (Tommasina, Sunderph, Malagoli), and the resistance is a metallic one as can easily be proved by an alternating current measurement. A force is necessary to separate the particles, but Fromme, Guthe, Shaw and Tissot have been unable to detect under ordinary conditions the slightest trace of an actual welding under the microscope. Here again we must be careful not to base our interpretation of the coherer action upon the effects produced by lightning (Stroh), discharges from a Leyden jar or an electrostatic machine (Tommasina) or by a strong electric current (Sunderph). As van Gulick points out, we can hardly speak of a fusion in the case of carbon which is known to form good coherers; Mizuno states that the lower the melting point the lower will be the resistance of the coherer, but his observation has not been confirmed by other investigators. It would also be difficult to explain, as found by Branly and Aschkinass, that a slight increase of temperature — not necessarily higher than the one at which the coherer action was produced — will restore the high resistance while a cooling has no such effect.

From a slightly different point of view Eccles, Ferrié and Shaw are led to believe that by the electrical influence short metallic bridges — possibly of metallic dust — are formed which break down

again on tapping. Sundorph's experiments on the formation of such bridges with large currents seem to support this view. The greatest objection to this theory is, however, that it will not embrace the phenomena of self-decohesion, of which we shall speak presently.

4. Branly believes that the nature of the dielectric between the conducting particles is changed by electrical impulses and that it becomes in some way conducting. A direct influence of this kind upon dielectrics has, however, never been observed and coherer action is entirely suppressed as Hurmuzescu and Childs have shown, if the insulating film is not extremely thin. The nature of the dielectric has also no influence upon the phenomena unless its viscosity is considerable (Fisch) or an electrolytic action is possible; filings in vacuo seem to act just as well as in air or other gases (Dorn, Jervis-Smith and Aurén). Huillier has shown that a change of the dielectric, after cohesion has taken place, will not affect the resistance. While we must therefore deny the possibility that the dielectric as such becomes the conducting agent, the theory may be modified, as will be shown later, so as to conform more closely to the observed facts.

5. Bose's interesting speculations lead to an exactly opposite conception of coherer action. Some filing tubes show an increase of resistance instead of a decrease, and others, especially those containing dry carbon, will decohere again as soon as the electrical influence ceases. This suggested to Bose that the metals exist in two allotropic forms, one being a poor conductor and the other a good one. According to the modification present we would observe a high or a low resistance. The change from one modification to another is produced by electrical oscillations. Strains due to the formation of the new molecular arrangement may, however, become so large that a sudden return to the more stable form, i. e., spontaneous decohesion, may set in.

Eccles has shown that a steady difference of potential has the same effect as electric oscillations and even Bose has admitted that the variation of the e.m.f. may be exceedingly slow and still produce this transformation in the metals. The results with decohering instruments are moreover often so variable with different degrees of excitation, that the assumption of different modifications in the metals seems rather to complicate the problem instead of bringing it nearer to a solution.

Shaw also assumes some kind of rearrangement or orientation of the molecules at the surface, though not necessarily resulting

in a new modification. He found that, after cohesion has set in, the contact been broken, and the electrodes brought together again at the same point, the resistance will be quite low — proving that the condition of good conductivity will remain for a short time at the surface of the metals.

6. An adequate theory of coherer action must take into account "decohesion," but frequently this phenomenon has as little to do with the real coherer action as have the visible sparks or the phenomena produced by excessive electrical influences. Schäfer's anticoherer is based upon the principle that fine metallic connections are broken and thus the resistance increased, a fact observed before by Lodge, Arons and Mizuno. Guthe shows the same effect for a single contact coherer, with a loose particle between the electrodes, and also a part of Blanc's results may be explained in the same way.

In the electrolytic decoherers, designed by Neugschwender, Tommasina and de Forest a very similar action takes place, and Tommasina proved that the decohering action which Bose observed is in many cases due to the breaking of a fine metallic film in the oil, while the metals behaved normally in air. In this connection it may also be stated that moisture has to be guarded against carefully in the construction of the coherer. It would however be wrong to explain all coherer action as an electrolytic phenomenon, as Busch does. The decohesion of coherers containing lead peroxide and copper sulphide was explained by Sundorph, Aschkinass and others as due to chemical action, and by Drogo as due to mechanical disturbance.

Instruments showing the sudden increase of resistance under the influence of electrical waves with following spontaneous decrease should not be called coherers; de Forest calls them "responders."

The self-restoring coherers, i. e., instruments the resistance of which decreases under the action of electric waves and then increases again, are however real coherers and will be treated in detail below.

7. Recent investigations have brought to light the existence of a "critical" voltage, i. e., a minimum difference of potential, which must be applied to the terminals of the coherer before a decided decrease of resistance takes place. Branly pointed out as early as 1891, that the voltage plays an important rôle. Aschkinass found in 1898 that if the potential difference is above a certain value the coherer cannot be restored to its original state by tapping. This he called the critical voltage, a definition adopted also by Blondel and

Dobkewitch two years later. Trowbridge defined in 1899 the critical voltage as the difference of potential which must be applied in order to produce coherer action and found it to be 8 volts for 20 steel contacts in series. Guthe and Trowbridge were able to show that for a given e.m.f. in the circuit the curves of the terminal potential differences of a coherer, plotted as functions of the current, exhibited for small currents only a slight increase of conductivity, but with increasing current the curves bend rather sharply and finally approach asymptotically a definite value, which was called the "critical voltage", though it may be objected that some coherer action takes place before this value is reached. This final value was found to be proportional to the number of contacts in series, while contacts in parallel will each respond when the voltage has reached its critical value, results which have been corroborated by the investigations of Fényi, Turpain and Robinson. Guthe extended the investigations to a large number of different metals and determined their critical voltages, which for single contacts lie between 0.05 and 0.25 volt. He also emphasized the fact that the critical voltage seems to stand in a definite relation to the atomic weight and the valency of the metal. Though usually the difference of potential is plotted as a function of the current, the curves show very plainly that the former depends also on the total resistance of the circuit, or, if you wish, upon the applied electromotive force. Taylor undertook a research in order to test these results. Though he obtained a number of curves agreeing closely with the types described, others varied considerably from it, showing a number of sudden steps in the value of the difference of potential. Robinson took up the problem again and found that with a single contact coherer the difference of potential has to be raised beyond that found by Guthe and Trowbridge, before coherer action sets in, but that with larger currents it will always drop to a value agreeing closely with theirs and which seems to be identical with the one defined by Aschkinass. He proposes therefore to call the latter the "impulse" value while he wishes to reserve the name "critical voltage" for the indefinite value at which coherer action sets in.

On the other hand Eccles obtained curves of exactly the same form as Guthe and Trowbridge by varying the difference of potential of a constantly agitated coherer and measuring the current. Also Bose in an interesting research obtained curves which show all the characteristics of Guthe and Trowbridge's curves, though the final values reached are somewhat higher. It may be pointed out here

that Guthe and Trowbridge always used freshly cleaned contacts, while Robinson's coherers were oxidized. The latter observes, besides, that the less the oxidation, the smaller the critical voltage. We have thus apparently in addition to the coherer effect proper, one due to the presence of an oxide film. Many observers are inclined to believe that such a film is necessary to produce the original high resistance. Dorn, Aschkinass, Tissot and others have shown, however, that this is not the case, but that the absence of oxide simply makes the original adjustment a little more difficult. Fisch in a recent investigation has come to the conclusion that the phenomena leading to Robinson's "critical voltage" do not form an essential part of coherer action.

8. We return now to the theories proposed for an explanation of coherer action. Guthe and Trowbridge assume that there is an electrostatic attraction due to the potential difference between the metallic particles — produced either by direct connection with a battery or by the e.m.f. induced by electric waves in the receiving system. This force brings the metallic surfaces within molecular range of each other, allowing ions to pass across the gap. Later, an increase of current will increase only the number of ions but not the potential difference.

This theory, accepted also by Wolcott, was later given in a somewhat modified form by Ferrié, but only as an explanation for decohesion, which the former did not attempt to account for. Ferrié follows Lodge in his conception of the regular coherer action; but assumes that in some cases the dielectric may be pushed aside by closely touching metallic particles, and that hereby a vacuum is formed. Under an electric influence a discharge takes place which increases the width of the vacuum space, but is restored to its original dimensions as soon as the excitation ceases.

9. In the following I shall formulate a theory along similar lines of reasoning and attempt to show its agreement with the perplexing multiplicity of phenomena observed in coherer action.

The first step is in general an electrostatic attraction between the metallic particles. Lodge has shown that two conductors separated by a film of air 0.00001 cm thick and having a difference of potential of one volt are attracted by a force of 44 atmospheres per unit area. Shaw found that the maximum distance at which traces of cohesion occurred was a little less than 0.00001 cm. The effect of electrostatic attraction may be shown indirectly. To illustrate I shall make use of a set of results obtained by Guthe and Trowbridge

(*Phys. Rev.*, vol. 11, pp. 26 and 27, 1899) with a single contact steel coherer, which was put in series with a variable resistance and an e.m.f. which in the different experiments was 6.5, 14, 60 and 220 volts respectively. While curves of the potential differences as functions of the current are entirely distinct from each other, we obtain a single curve for all four series, if we plot the terminal potential difference and the reciprocal of the total resistance of the circuit.

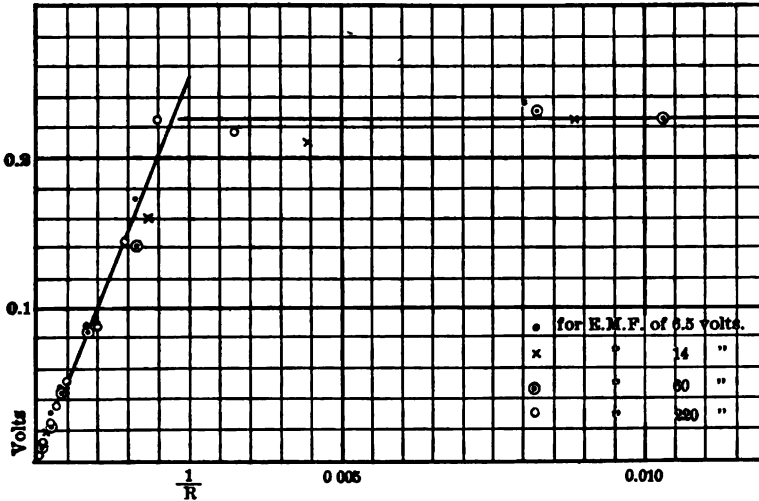

DIAGRAM SHOWING RELATIONS BETWEEN VOLTAGE AND CONDUCTANCE.

We see from the figure that in all four cases the difference of potential is at first inversely proportional to the total resistance, or, in other words, that the resistance of the coherer is inversely proportional to the applied e.m.f., and that as long as the latter is constant, it will not change until the terminal difference of potential rises to nearly the critical voltage. On the other hand, if the external resistance is kept constant and the e.m.f. increases we must expect even in the early part of the curve a slight lowering of the coherer resistance, and this is what Eccles, Bose and Robinson have found.

If we release the electrical stress at this stage there will be at least a partial elastic return to the original condition, as observed by Bose, Robinson and Blanc.

10. That in the coherer we have to do with very small distances follows also from a consideration of the critical voltages. From

Earhart's investigations on sparking distances² we may calculate that one volt would be required to bridge a gap 0.0000006 cm wide. Guthe found as critical voltages 0.062 volt for silver and 0.22 volt for iron, which would allow for the distances at which the real coherer action sets in, only 3.5×10^{-8} cm and 13.3×10^{-8} cm respectively.

I will not discuss the question whether or not the relation between the critical voltages and the atomic weights, alluded to above, has anything to do with these molecular distances.

According to modern theory free electrons are moving about in the metals in every direction. J. J. Thomson says:³ "One of the reasons the corpuscles do not escape from the metal is that as soon as they leave the metal there is an electrostatic attraction between the corpuscles and the metal equal to $\frac{e^2}{4r^2}$ where e is the charge on one corpuscle and r the distance of the corpuscle from the surface of the metal." But in our case we have a strong external electrostatic field which will assist the electron in leaving the metal by increasing its kinetic energy. Thus electrons will be carried over from the metal charged negatively to the other side and we have an electric current, carried on entirely by the electrons. On this account we are unable to observe a transference of metal in the coherer even after it has been used for some time. A close parallel to this is found in an electric arc between cooled electrodes.⁴

As soon as the metals have been brought within molecular range, an increase of the electrical energy will produce only an increase of the number of electrons, i. e., the current will increase while the difference of potential remains constant. We cannot call this transference of electricity a spark in the ordinary sense, even disregarding the small distance, because the heat effect of the spark is absent.

The passage of electricity is accompanied by a pressure at right angles to the flow⁵ and this will push aside molecules of the dielectric which were possibly lodged between the metallic particles, and there remains what we may consider a continuous metallic conductor.

11. After the electrical impulse ceases we can hardly expect a return to the original state unless some force is applied to separate the particles, in other words the resistance has been permanently lowered. Now, suppose that we separate the electrodes. In a short

2. Earhart, *Phil. Mag.*, vol. I, p. 147, 1901.

3. Thomson, "Conduction of Electricity through Gases," p. 386.

4. Weedon, *Trans. Am. Electroch. Soc.*, vol. 5, p. 171, 1904.

5. Semenov, *Journ. de Phys.*, vol. 3, p. 125, 1904.

time the dielectric will condense again upon the metallic surfaces and the original high resistance is restored. But if immediately after separation the metals are brought together again at the same point, the dielectric has not found time to condense and the resistance is still small, as Shaw's observations show. In this case a reversal of the current seems even to be favorable to a return of electrons. Possibly an electrolytic or chemical action may be the cause of this.

A tapping or shaking of the coherer displaces the particles with respect to each other and brings into contact new points at which the dielectric is not removed.

12. Another point which is in favor of this theory is the influence of temperature upon coherer action. It is well known that heated powders are good conductors. Guthe showed that on heating a single contact its resistance became very small and the critical voltage dropped practically to zero, and that both returned to the original values on cooling. The similarity between this and the effect of heating the kathode in a vacuum tube is apparent.

13. So far we have considered only the case where the metallic areas in immediate contact are large enough to supply practically all the electrons necessary to carry the current. But let us suppose that this is made impossible by the shape of the particles, for instance where the surfaces are rough or where sharp points form the contact. The coherer would, in this case, offer a larger resistance than under ordinary circumstances — and this is characteristic of the self-restoring instruments.

Doubtless in some cases, especially when the restoring power was observed under very weak influences, we have to assume that only the first of the two steps described above is produced, while a stronger excitation results in a permanent lowering of the resistance.

In other cases this cannot be the reason for spontaneous decohesion. An ionization of the surrounding gas must in part assist in the transference of the electrons, but will disappear again with a corresponding increase of the resistance, — as soon as the electrical excitation ceases. The ionization depends on the energy supplied; the resistance will therefore become smaller, as the applied e.m.f. increases, but return to a higher value when the e.m.f. is lowered. With a constant e.m.f. and a small external resistance in the circuit the decrease in the potential difference of the coherer when the current is established may allow a recombination of the gas molecules, accompanied by an increase in the potential difference, which in its turn will again make the current larger, thus

repeating the phenomenon. The combination of the e.m.f. and the resistances in the circuit are in this case such that the system is just on the verge of coherer action, and periodic alternations of this kind may give rise to musical sounds, as have been noticed by Ferrié and Hornemann. In vacuum tubes also such sounds can be produced.

14. As Warburg has first pointed out, there is always a retardation of a spark discharge, unless the surrounding medium is ionized by some independent outside action. A retardation of coherer action has first been observed by Aschkinass, who suggested a relation between the two phenomena, and later by Bose, Robinson and Hurmuzescu. Especially when the applied e.m.f. is near the critical voltage the "creeping of the resistance" is very striking, considerable time being needed for the sufficient ionization of the medium.

15. Finally it has been frequently observed that coherers show a tendency to fatigue, i. e., after some use they become less sensitive. In many cases this is due to an increase in thickness of the oxide film. But as Huth has shown, this cannot be the only explanation. In his experiments, in which paraffin oil or air formed the dielectric a fatigue is very apparent. In the case of the coherer containing the oil a recovery was noticeable after the instrument was left undisturbed for 12 hours. In the one containing the air admission of fresh air produced an almost complete return to the original state. We have here the same effect which is observed in discharge tubes. In the filing coherer the effect may be even more noticeable on account of the large number of solid particles which do not take part in the coherer action but remove some of the ions from the path which the current is forced to follow by the given arrangement of the particles.

16. While we have distinguished so far the two ideal cases, one in which the current is due to the electrons from the metals alone and the other in which the ions of the surrounding medium are the principal carriers of electricity,— we have doubtless a mixture of the two cases in most types of coherers, especially in the filing tube. The "partial" return to higher resistance on lowering the applied e.m.f., noticed by Bose, Ketterer and Blanc point to this conclusion. However, the results obtained with filing coherers are not easily interpreted. The shaking of the tube in order to decohere the instrument may produce a new arrangement of the particles and new conditions. While at first spontaneous decohesion may be predominant, in course of time the particles, especially if they are loose (Rochefort) may settle down with surfaces in contact large enough to produce permanent cohesion.

It takes a freshly filled filing tube a considerable time to reach a somewhat steady condition, as is brought out forcibly by Bose and Hurmuzescu. In the formulation of a theory we have to rely principally upon results obtained under well defined conditions, and these we find only in the case of coherers consisting of a single or of only a few contacts.

BIBLIOGRAPHY.

Fairly complete lists of the earlier papers on the coherer may be found in Righi and Dessau's book: "Die Telegraphie ohne Draht," p. 232, and in Schlabach's paper, *Physikalische Zeitschrift*, vol. 2, p. 385, 1901.

In order to bring the latter's list up to date, the following references are added:

1900.

- | | |
|------------------------|-----------------------------------------------------------------|
| Blondel. | <i>C.R.</i> , vol. 130, p. 1383. |
| Blondel and
Ferrié. | <i>Rapports au Congr. intern. d'Electr.</i> , p. 321. |
| Bose. | <i>Rapports au Congr. intern. de Phys.</i> , vol. 3,
p. 561. |
| Branly. | <i>Rapports au Congr. intern. de Phys.</i> , vol. 2,
p. 325. |
| Ferrié. | <i>Rapports au Congr. intern. d'Electr.</i> , Ann.
p. 285. |
| Popoff. | <i>Rapports au Congr. intern. d'Electr.</i> , Rapp.,
p. 236. |
| Trowbridge. | <i>Nature</i> , vol. 63, p. 156. |

1901.

- | | |
|---------------|-----------------------------------------------------------------------------|
| Bose. | <i>The Electrician</i> , vol. 47, pp. 830, 877. |
| Collins. | <i>El. World and Eng.</i> , vol. 38, p. 251. |
| Cornet. | <i>Ecl. Elec.</i> , vol. 27, p. CLIV. |
| Drago. | <i>N. Cim.</i> , vol. 2, p. 319. |
| Eccles. | <i>The Electrician</i> , vol. 47, pp. 382, 715. |
| Gansauge. | <i>Journ. Telegr.</i> , vol. 25, p. 97. |
| Guthe. | <i>Phys. Rev.</i> , vol. 12, p. 245.
<i>Ann. Phys.</i> , vol. 4, p. 472. |
| Kinsley. | <i>Phys. Rev.</i> , vol. 12, p. 177. |
| Marx. | <i>Phys. Zeit.</i> , vol. 2, pp. 249, 574. |
| Neuschwender. | <i>Phys. Zeit.</i> , vol. 2, p. 550. |
| Odenbach. | <i>West. Electr.</i> , vol. 29, p. 349. |

- Righi. *Ecl. Elec.*, vol. 27, p. 373.
 Schlabach. *Phys. Zeit.*, vol. 2, pp. 374, 383.
 Shaw. *Phil. Mag.*, vol. 1, p. 265.
 Tommasina. *C.R.*, vol. 132, pp. 132, 627.
Arch. sci. phys et natur., vol. 11, p. 557.
 Turpain. *Ecl. Elec.*, vol. 27, p. 56.
 Wolcott. *Bull. Univ. of Wis.*, vol. 3, p. 1.

1902.

- Bleekrode. *Nature*, vol. 66, p. 360.
 Bose. *Proc. Roy. Soc.*, vol. 70, pp. 154, 174.
 Branly. *C.R.*, vol. 134, pp. 132, 347, 1197.
Journ. de Phys., vol. 1, p. 183.
The Electrician, vol. 48, p. 730.
 Drago. *N. Cim.*, vol. 4, p. 208.
 Fényi. *C.R.*, vol. 135, p. 30.
 Hornemann. *Ann. Phys.*, vol. 7, p. 862.
 Jervis-Smith. *The Electrician*, vol. 50, p. 111.
 Ketterer. *Journ. de Phys.*, vol. 1, p. 589.
 Milewski. *Zeit. phys. chem.*, vol. 16, p. 223.
 Minchin. *Elec. Rev. (Lond.)*, vol. 51, p. 770.
 Muraoka and Tamaru. *Ann. Phys.*, vol. 7, p. 554.
 Parker. *Trans., New York Ac. of Sci.*, vol. 15, p. 5.
 Piola. *Ecl. Elec.*, vol. 33, p. LXIII.
 Rochefort. *C.R.*, vol. 134, p. 380.
 Taylor. *Phys. Rev.*, vol. 15, p. 39.
 Turpain. *Ecl. Elec.*, vol. 32, p. 337.
 Weber. *Naturw. Rundsch*, vol. 18, p. 439.

1903.

- Aurén. *Ark. Math. Astr. och Fys.*, vol. 1, p. 25.
 Blanc. *C.R.*, vol. 137, p. 1042.
 Drago. *Atti. Acc. Gi. d. cat.*, vol. 15; *N. Cim.*, vol. 6,
 p. 197.
 Hanchett. *Elec. Rev. (N. Y.)*, vol. 42, p. 599.
 Hurmuzescu. *Ann. sci. de l'Univ. Jassy*, vol. 2, p. 141.
 Huth. *Phys. Zeit.*, vol. 4, p. 594.
 Lodge. *Proc. Roy. Soc.*, vol. 71, p. 402.
 Marconi. *The Electrician*, vol. 49, p. 388.
 Piola. *Electricista*, vol. 12, p. 32.

- Robinson. *Ann. Phys.*, vol. 11, p. 754.
Phys. Rev., vol. 17, p. 286.
 Sundorph. *Ann. Phys.*, vol. 10, p. 198.
 Taylor. *Phys. Rev.*, vol. 16, p. 199.
 Turpain. *C.R.*, vol. 137, p. 562.

1904.

- Busch. *Elec. Zeit.*, vol. 25, p. 160.
 Fisch. *Jour. de Phys.*, vol. 3, p. 350.
 Hornemann. *Ann. Phys.*, vol. 14, p. 129.
 Maurin. *C. R. de l'Ass. Tr. pour L'Ad. Sci.*
 Schniewindt. *Elec. Zeit.*, vol. 25, p. 236.
 Shaw and
 Garrett. *The Electrician*, vol. 53, p. 310.
 Turpain. *Jour. de Phys.*, vol. 3, p. 443.

DISCUSSION.

CHAIRMAN ARRHENIUS: Is there anyone who wishes to enter into a discussion upon this paper?

DOCTOR THOMAS: Is it purely an e.m.f. in the vacuum tubes that determines the voltage?

DOCTOR GUTHE: Yes; it is. It is that voltage which is necessary to produce and sustain ionization.

CHAIRMAN ARRHENIUS: Tomorrow there will be held a joint meeting of the American Physical Society and Section A. There is nothing more on the programme for today, and therefore I adjourn the meeting until tomorrow at 9:30.

FRIDAY MORNING, SEPTEMBER 16, 1904.

In Joint Session with the American Physical Society.

Pursuant to adjournment, the meeting was called to order at 9:30 A. M., Prof. A. G. Webster, President of the American Physical Society, in the chair.

CHAIRMAN WEBSTER: Gentlemen, the Section will please come to order. We have this morning a joint session of the Section with the American Physical Society. The first paper on the list is that of Professor Arrhenius, who has not yet arrived; we hope to have that next. The next paper is by Dr. Carl Barus, who is not present: "Atmospheric Nuclei." The next is by Dr. L. A. Bauer, on "The Earth's Magnetism."

Dr. L. A. Bauer then read his paper on "The Earth's Magnetism."

RECENT ADVANCES IN THE ANALYSIS OF THE EARTH'S PERMANENT MAGNETIC FIELD.

BY DR. L. A. BAUER.

The "Earth is a great Magnet" and as such is subject to the same laws which pertain to any other magnet — these are facts established by the experience of over four centuries. How and whence the earth has received its magnetism are questions we cannot as yet answer, nor in my opinion shall we be able to answer them definitely until we have solved the problems as to the causes of the variations of the earth's magnetism. I firmly believe that when we have discovered the causes of the periodic and aperiodic variations, such as the diurnal variation, annual variation, secular variation, and magnetic perturbations, we shall have strong hints given us as to the origin of the earth's magnetism. It is then through the study of the variations that we hope some day to be able to attack the problem as to the origin with some degree of success. Until this study has been completed, it is not believed that anything more than mere surmises, such as the magnetic literature contains *in quanto*, can be given.

Whether the earth is a magnet like a lodestone, or an electro-magnet, is another question which cannot as yet be definitely answered, though there are various indications that the earth's magnetization partakes of the character of both. Here again the definitive answer depends upon the successful solution of the questions as to the variation of the earth's magnetism both as to time and space.

These introductory paragraphs are intended to emphasize the proposition, that if progress is to be made in the subject of the earth's magnetism, we must first make a careful and exhaustive study of the facts which are daily experiences, before attempting broad, theoretical generalizations based on more or less inadequate data permitting at the most mere qualitative tests of the deductions of theory. What are needed are the facts for quantitative tests.

Even then it will be found, in some instances, that more than one theory will satisfactorily explain the same facts and that a final decision must be left to future generations. However, the facts will remain as a permanent acquisition. The accumulation of facts regarding the earth's magnetism is the great task of the present generation.

In the hope of enlisting interest in this comparatively unexplored field of scientific inquiry, it will be my endeavor to reveal some of the gaps to be filled, as well as to exhibit those facts considered as safely established. Remember that we are working in a field bordering on several other sciences, such as astrophysics, geophysics, geology, and meteorology, so that he who wishes to become an expert must have at his command the ability to make the best and most intelligent use of the experimental facts of several of the older, recognized sciences. The physicist now-a-days has no time to attempt to master so special and comprehensive a subject as that of the earth's magnetism, with its manifold ramifications into cognate sciences, for he finds it sufficiently difficult to keep in touch with the rapid advances in his own subject. However, if the physicist, the mathematician, the geologist, or the astrophysicist have presented to them the problems of the earth's magnetism concerning them specially, definite advance along certain lines may be confidently expected. The point then made is that the successful solution of some of the vexing problems of the earth's magnetism, in this day of rapid advances in experimental research, cannot be attempted by one individual; he must associate with him experts in several of the older, fundamental sciences and have at his command a staff of computers. It must, hence, be a source of great gratification that this dream has been realized in the establishment by the Carnegie Institution of a Department of International Research in Terrestrial Magnetism, with facilities for adequately and exhaustively collecting, collating, supplementing, and discussing magnetic data. With such means, let us hope that before very long we may be able to present a more favorable report on the state of our knowledge regarding the earth's magnetism than the one it is my privilege to lay before members of the Congress in this paper.

One of the most fundamental inquiries to be made in the discussion of any of the earth's magnetic phenomena, before attempting a theoretical explanation, is as to the *seat* of the forces giving rise to the phenomenon in question. Thus many a theorist might

have saved himself some pains had he first addressed himself to this inquiry.

To illustrate, suppose our first question to be: Since we can produce the magnetic phenomena pertaining to the earth's so-called "permanent" magnetism, observed on the surface, by a system of closed electric currents, where are these currents? Do they circulate around the earth below the surface, or in the regions above us? We know, as a fact of common experience, that the end of the needle designated as the north-seeking end, or for short, the north end, points approximately toward the north. Hence, applying Ampere's rule, the electric currents necessary to produce this phenomenon must circulate around the earth from east to west, if they be *inside* the earth; and if they are, on the other hand, *outside* the earth, they must circulate from west to east. To determine where the currents really are we must resort to another well-known phenomenon, viz., that the end of the needle which points to the north dips below the horizon in our hemisphere and points above the horizon in the southern magnetic hemisphere. Applying to this phenomenon Ampere's rule we shall find that the currents can only circulate from east to west; hence combining this deduction with our previous one, the answer is that the electric currents which are capable of producing the observed magnetic phenomena cited must be imbedded in the earth and that they circulate from east to west around the earth.

Now this is a perfectly simple and obvious application of a fundamental law in electromagnetism, and yet for want of this test many eminent investigators have lost valuable time and even to-day some cases of transgression or omission might be cited. Thus, some of the modern theories of the secular variation suppose that the electric currents causing this variation are chiefly outside of the earth. However, according to recent calculations, as based virtually upon the mathematical application of Ampere's rule, it is found that the observed facts can be made to harmonize best with a system of forces situated chiefly inside the earth. [My most recent calculations also reveal a minor system of outside currents taking part in the production of the observed secular variation.]

The first one to make a mathematical test of the seat of the earth's magnetic forces, coupled also with an analysis into spherical harmonic terms to the fourth order, was Gauss, who ushered in a new era in magnetic science. As the result of his mathematical analysis, it was definitely proven that by far the greatest portion

of the earth's permanent magnetism is to be referred to a system of forces inside the earth, and furthermore, that this system possesses a potential. There were thus deduced two great fundamental facts of nature that outweighed in importance all of the speculative theories concerning the "how and whence" of the earth's magnetism of the previous centuries.

Gauss' calculations have been repeated several times with the aid of more complete material by several analysts, one of them being the noted astronomer-mathematician, John Couch Adams; Gauss' deductions have been verified by all of them.

The most elaborate analysis and attempt at perfection of the theory embodied in the Gaussian analysis was that for 1885 by Prof. Adolf Schmidt, at present in charge of the Potsdam Magnetic Observatory in succession to the late and lamented Professor Eschenhagen. Schmidt made provision in his equations: (a) for the effect of the spheroidal figure of the earth, Gauss having taken a spherical figure; (b) for a possible effect due to forces whose seat was outside the earth; and (c) for a possible effect not to be referred to an inside or outside potential, but to a system of vertical electric currents passing through the earth's surface, whether from inside or outside.

Schmidt found that about 95 per cent of the total magnetization of the earth was to be referred to an inside potential and that the remainder was due to a small outside potential and an electric current system traversing the earth perpendicularly to its surface.

Fritsche in the main verified Schmidt's work, though he did not introduce the refinement due to taking into account the spheroidal figure of the earth, but retained the simpler equations based on the spherical figure.

The writer has recently made a critical comparison of the results thus far obtained by the various analysts, and has derived the differences between the elements as computed upon the basis of the theory and the observed or chart quantities, his purpose being to ascertain wherein further improvement of the theory is needed and what direction promises the best success. The residuals many times exceed the errors of observation.

It would appear that at the present stage very little increased accuracy has been gained by taking into account the spheroidal figure of the earth, and that the theory must receive elaboration in other fundamental directions. Thus, for example, suppose the principal portion of the earth's magnetic system to be situated

at some considerable depth below the surface — a condition of which we have in fact indications — then the question must be considered as to the effect arising from the magnetic permeabilities of the strata intervening between the seat of the system and the place of measurement of the forces. Instead of having the simple Laplacian equation, and, as the result of which, a strictly harmonic distribution of the forces, we may have instead the more generalized equation:

$$\frac{d}{dx} \left(\mu \frac{dV}{dx} \right) + \frac{d}{dy} \left(\mu \frac{dV}{dy} \right) + \frac{d}{dz} \left(\mu \frac{dV}{dz} \right) = 0$$

and in consequence a quasi-harmonic distribution. So that the Gaussian potential expression, based on the simple Laplacian equation, may represent only a first approximation to the truth.

The material for testing this hypothesis, however, is not yet either at hand or sufficiently complete.

And here we must record a most lamentable condition of our knowledge regarding the general distribution of the earth's magnetic forces. One of the surprising results of my critical comparison, above referred to, was the fact that the accuracy in the determination of the earth's magnetic potential is about the same whether we use the magnetic charts of Sabine of 1840-1845 or the best modern magnetic charts. In other words, whereas magnetic surveys have steadily progressed on land areas and even have been repeated in certain instances in greater detail, the magnetic survey of the great oceanic areas and of the unexplored land regions has made very little progress during the past half century. The advent of the iron ship has materially lessened the yield of useful magnetic data and the expeditions designed for securing sea results have been unfortunately too few and far between. In the Antarctic regions, for example, practically no progress had been made since the observations of Ross in the "Erebus" and "Terror" during the fourth decade of the last century until the recent Antarctic expeditions of the British and German empires.

Fortunately, however, there is an awakening interest in this direction. Thus a committee has been appointed by the International Association of Academies at its recent meeting in London, to consider methods for securing increased accuracy in magnetic work at sea. Furthermore, the plans of the Department of Terrestrial Magnetism of the Carnegie Institution embrace co-operation in the magnetic survey of the oceanic areas and it is con-

fidently hoped that a beginning in this direction can soon be made. Instruments for this purpose have already been ordered. Also, I am glad to be able to announce, that having succeeded in organizing the detailed magnetic survey of the land area of our country, attention has next been paid to inaugurating similar work at sea on the coast and geodetic survey vessels; three of them have already been fully equipped for this purpose, and this fall two more will receive their magnetic equipments. While these vessels can only obtain magnetic data incidentally in the course of their surveying work, experience has shown that a very satisfactory degree of accuracy can be secured by their skilled officers. The magnetic declination and dip can be obtained, for example, to about 5' to 10', and the total force to about 1/500 part.

We next inquire, Is the earth's magnetic energy increasing or decreasing? This is a question of fundamental importance to theories of the earth's magnetism. As is well known, the earth's magnetic elements are subject to a secular variation whereby considerable changes are produced in the course of time. A secular variation may result from a change in the intensity of the magnetization of the earth, or from a change of the direction of magnetization, or from both causes. It would appear as though the greater portion of the secular variation is to be referred to a change in the direction or directions of the magnetization.

The first term of the Gaussian potential is of a simple harmonic type and constitutes by far the largest term; it represents about 65 to 70 per cent of the total magnetization and can be physically interpreted as a uniform or homogeneous magnetization symmetrical about a diameter, inclined $11\frac{1}{2}$ deg. to the earth's axis of rotation. This diameter Gauss defined as the earth's magnetic axis, with respect to which he determined the magnetic moment due to the first term. Tabulating the values of the magnetic moment as derived for different epochs from the various analyses, we shall find that it has decreased in 46 years by 1.6 per cent — an alarming loss, if true!

The question now is, whether this apparent loss is in any way wholly or partially compensated for by a possible increase in magnetic energy of the portion of the earth's magnetism represented by the remaining terms of the Gaussian potential, i. e., by the portion which cannot be referred to a uniform magnetization about some diameter? If mutual compensation does not take place, what is the annual loss of the earth's total magnetization?

To answer this query, I have made use of the well-known function in physics giving the energy W , of a distribution of forces in terms of the field intensity, F , viz.:

$$W = \frac{1}{8\pi} \int \mu F^2 dv = \frac{1}{8\pi} \iiint \mu (X^2 + Y^2 + Z^2) dx dy dz,$$

where μ is the magnetic permeability and dv is the element of volume and X, Y, Z are the rectangular components of F . The integral is confined to the space outside of the earth, so that we may take μ as a constant and set it equal to 1. We may also give the expression the following form:

$$W = -\frac{R^2}{8\pi} \int VZ ds.$$

Here V is the magnetic potential and Z the vertical force on the earth's surface, R the earth's mean radius and ds the element of surface. As a check I have made some of the calculations with both forms and have gotten, of course, identical results.

The following table gives the values of the magnetic energy as derived for the various epochs and as dependent upon the best of the analyses thus far made:

TABLE I.—VALUES OF THE EARTH'S TOTAL MAGNETIC ENERGY IN C. G. S. UNITS (ERGS).

(The tabular numbers are to be multiplied by the cube of the earth's mean radius.)

No.	Computer of potential.	Epoch.	I.	II.	III.	IV.	II. + III. + IV.	Total.
1.....	Erman—							
	Peterson....	1829	.08562	.00026	.00015	.00004	.00045	.08607
3 and 6..	Adams.....	1842.5	.08590	.00 29	.00015	.00008	.00047	.08637
4.....	Fritsche.....	1842.5	.08614	.00028	.00014	.00008	.00045	.08659
8.....	Adams.....	1880	.08481	.00036	.00017	.00004	.00057	.08538
9.....	Fritsche.....	1885	.08472	.00034	.00015	.00004	.00053	.08525
	Neumayer							
5 and 11.	Peterson....	1885	.08464	.00035	.00016	.00004	.00055	.08519
10 and 13.	Schmidt.....	1885	.08494	.00034	.00015	.00004	.00053	.08543
.....	Mean of first three.....	1838	.0856900046	.08635
.....	Mean of last four.....	1884	.0847800054	.08532
.....	Change in....	46 years	-.00111	+.00008	-.00103

Thus we have:

For the year 1838 the earth's total magnetic energy, 0.03635 R³ ergs

For the year 1884 the earth's total magnetic energy, 0.03532 R³ ergs

Or a loss of 0.00103 R³ ergs
Or 2.88 per cent; or about 1/35 part in 46 years.

This result is such a startling one, for, if true and if the loss in the earth's magnetization continued at the same rate as prevailed during the period 1842-1885, it would imply that the earth will have lost its magnetic energy in about 1600 years; hence extreme caution should be employed before reaching a definite conclusion. I have made some attempt to ascertain whether this loss can be accounted for by the difference in the material used in the construction of the various charts, and while it would appear that the loss is greater than the effect due to the difference of material, I am unwilling at present to announce a definite conclusion, but think it best to leave this question, at present, open.

Allusion was made above to the possible existence of vertical electric currents passing through the earth's crust, as revealed by Schmidt's analysis. He found that there was on the average for the entire earth, for every square kilometer of surface, a current of $1/6$ of ampere, passing perpendicularly through the surface, either from the air into the earth, or *vice versa*. However, as certain investigators found it difficult to harmonize a current of this strength with the known phenomena of atmospheric electricity, and since similar investigations conducted over well-surveyed, though restricted, areas, by several eminent magnetists did not reveal these currents, Schmidt was led to doubt his result and ascribe it to systematic map errors.

The existence of these currents is revealed by the non-vanishing of the line integral of the magnetic force taken around a closed curve on the earth's surface. Such line integrals serve as a test of the hypothesis of a potential, as was first shown and approximately applied by Gauss. Let us choose, as our circuit, a parallel of latitude and let us call, as is customary, the component of the horizontal magnetic force resolved in a west-east direction, the Y component; then, if $d\lambda$ is the element of the parallel,

$$\int_0^{2\pi} Y d\lambda = 0,$$

if the earth's entire magnetic force is due to a potential. If, on the other hand, electric currents of the kind mentioned exist, then, if I represents the total amount of electricity passing per second of time through the zone from the north geographical pole down to the parallel around which the circuit is made, expressed in electromagnetic units, we have:

$$I = \frac{1}{4\pi} \int_0^{2\pi} Y d\lambda.$$

In a paper published in 1897, I computed the values of I for every fifth parallel from 60 deg. N. to 60 deg. S. as based on Neumayer's magnetic charts for 1885, and also gave a graphical representation along a meridian of the average distribution of the currents found. The resulting system was such a methodical one as to strongly suggest that there might be some truth after all in the existence of vertical earth-air electric currents.

With the aid of the facilities of the Department of Terrestrial Magnetism of the Carnegie Institution, I recently have had my calculations for 1885 repeated for two other epochs, viz., first as based upon Sabine's magnetic charts for 1840-1845, which depended upon magnetic data distributed over about seven decades with the date 1840-1845 about in the middle of the series; and secondly, as based upon Creak's charts for 1880, issued just after the magnetic results of the "Challenger" expedition were available to him.

A further check upon the computations was obtained by a consideration of the magnetic declination charts alone, viz., for four epochs — Sabine (1840-1845), British Admiralty (1858), Creak, 1880, and Neumayer, 1885. The calculations were based on the following principle: The downward electric currents will deflect the north end of a magnetic needle to the west, whereas the upward currents will deflect the north end to the east. The results obtained thus agreed well with that obtained from the Y components.

The mean results as derived from all the computations are given in the following table:

TABLE II.—VERTICAL EARTH-AIR ELECTRIC CURRENTS.

[Plus sign means upward currents, minus sign downward currents.]

Zone.	I in 10^4 A.	Zone.	I in 10^4 A.	i in Am- peres per sq. km.
50 N to Equator	-419	50 N to 40 N	+120	+.688
40 N to Equator	-539	40 N to 30 N	+ 5	+.001
30 N to Equator	-544	30 N to 20 N	-231	-.057
20 N to Equator	-318	20 N to 10 N	-228	-.052
10 N to Equator	- 90	10 N to Equator	- 90	-.090
Equator to 10 S	+105	Equator to 10 S	+105	+.024
Equator to 20 S	+208	10 S to 20 S	+ 98	+.023
Equator to 30 S	- 9	20 S to 30 S	-212	-.058
Equator to 40 S	- 86	30 S to 40 S	- 77	-.021

For example, through the region of the earth between the parallels 50 deg. N. and the equator, the resultant quantity of elec-

tricity passing every second of time from the air into the earth represents a current of 419×10^4 amperes. In the zone between the two parallels 50 deg. N. and 40 deg. N., the resultant currents are upward and the total amount of electricity passing per second of time from the earth to the air represents 120×10^4 amperes; dividing the latter quantity by the total area of the zone, the upward current is found to average for the zone 40 N. to 50 N., 0.038 ampere per square kilometer. The quantities i in the last column give a maximum downward current in the zones 20 N. to 30 N. and 20 S. to 30 S., and upward currents near the equatorial belts, and again beyond parallels 30 deg.

The general conclusion to be drawn appears to be:

All of the modern magnetic charts — i. e., since those of Sabine for 1840–1845 — unite in indicating the probable existence of vertical earth-air electric currents of the average intensity over the region 45 deg. N. to 45 deg. S. of $1/30$ of an ampere per square kilometer of surface. These currents of positive electricity proceed upward (from the earth into the air) near the equatorial regions where there are ascending air currents, and downward near the parallels 25 to 30 deg.; i. e., in the regions of descending air currents. Near the parallels 40 deg. the electric currents are again upward, thus corresponding once more with the general atmospheric circulation. Beyond the parallels 45 deg. the results appear too uncertain to warrant drawing a definite conclusion.

If it be true that the vertical electric currents are to be associated with air currents, and are hence convection currents, the importance of choosing circuits for testing the validity of the potential hypothesis in localities of steady air currents is made manifest. It is thus clear that meteorological conditions may play an important part — as already pointed out in my 1897 paper — in investigations as to the existence of vertical electric currents from magnetic surveys over limited areas.

In order to make some tests as to the manner of distribution of the upward and downward electric currents, the currents over quadrilaterals bounded by two parallels 10 deg. apart and two meridians, likewise 10 deg. apart, have been derived for the entire region from 60 deg. N. to 60 deg. S., for the three epochs, 1842, 1880, and 1885. As a general result it did not appear as though the directions of the electric currents — whether up or down — were to be associated with the distribution of land and water. There was, however, a decided indication, for each epoch, that over the areas of

low pressure, where the air-currents are upward, there the electric currents were likewise, in general, upward, and that over the areas of high pressure where there are descending air-currents, there the electric currents were likewise descending.

Thus, as the average result, from the three epochs we have:

Region.	Quantity of electricity.
60° N. to 60° S.	{ For areas of low pressure: $+829 \times 10^4$ amperes.
	{ For areas of high pressure: -638×10^4 amperes.

+ means upward electric currents; - downward electric currents.

The average effect of electric currents for the region 45 N. to 45 S. is on the east-west component of the earth's magnetic force (Y), 0.001 c.g.s. unit, or about 1/50 of the average value of Y . The average effect on the horizontal intensity is about 1/1000 part; i. e., on the order of the error of a field determination. However, the average effect on the declination is about 0.2 deg.—about six times the error of a reduced field determination of the declination on land, and about one to two times the error of a determination at sea by the most approved methods.

Having given the results to be deduced from a mathematical analysis of the earth's permanent magnetic field in accordance with the principles laid down by Gauss, let us now briefly turn our attention to another mode of attack, with the purpose of deriving physical interpretations of the various harmonic terms entering into the Gaussian expression. The general title of the series of the papers devoted to this subject, of which the fourth number appeared in the September issue of the journal, *Terrestrial Magnetism and Atmospheric Electricity*, is "The Physical Decomposition of the Earth's Permanent Magnetic Field."

The first harmonic finds a ready physical interpretation; it represents that entire portion of the earth's total magnetization which can be referred to a uniform homogeneous magnetization of the earth about a diameter inclined to the axis of rotation. This term represents about 65-70 per cent of the total field. Let us term it the primary or "normal" field.

The diameter or axis of magnetization of this field for 1885 made an angle of $11^\circ 25.7'$ with the rotation axis and pierced the northern hemisphere in longitude $68^\circ 30.6'$ W. of Greenwich. Its magnetic moment was $0.32298 R^3$, c.g.s. units, R being the earth's mean radius. These figures were dependent on Schmidt's analysis of the

earth's permanent magnetism, and a slight revision would be required in accordance with his latest published Gaussian coefficients. However, as it was found that these slight revisions are on the order of error of determination, it will, therefore, not be worth while at present to make any change.

In No. II of the series of papers alluded to, it was shown how the determinations of the magnetic axis and of the magnetic moment were dependent upon the portion of the earth considered in the calculations, so that, strictly, the quantities adopted apply only to the area embraced. Fortunately, however, the effect of the neglected portions of the earth — the polar regions — diminishes rapidly with advancing latitude, so that the values as adopted for the primary field, depending as they did upon data from 60 deg. N. to 60 deg. S., will not differ sufficiently from those obtained, had there been data over the entire globe, to vitiate the general deductions regarding the characteristics of the "residual" or "secondary field," i. e., that portion of the earth's total magnetization remaining after deducting the homogeneous magnetization (the first term).

The map of this residual field has now been constructed for three epochs, first, for 1885 and recently also for 1842 and 1880, the first depending on Neumayer's magnetic charts for 1885, the second on Sabine's charts, and the third upon Creak's charts.

The residual magnetization can thus be broadly characterized: It consists chiefly of two main magnetizations transverse to the axis of rotation, one system lying in the northern hemisphere, the north-end attracting pole (N_1) being east of the south-end attracting poles (S'_1, S''_1); the other in the southern hemisphere, the direction of magnetization being the reverse of the former, the north pole (N_2) lying now west of the south pole (S_2). The poles of the two systems are situated, approximately, near the 40 deg. parallels — this is even true of the tertiary system N_3, S_3 .

The secondary magnetic equators (the lines along which the residual vertical force is zero) occupy practically the same positions for the three epochs. It is as yet too early to decide as to any probable secular shifting of the positions of the secondary poles. The interval is too short, in view of the meagerness of the data on which the charts depend, to make certain any deductions.

What has thus far been gained by the decomposition of the earth's total magnetic field into a primary and into a secondary one?

In the first place, the residual field clearly exhibits the fact that

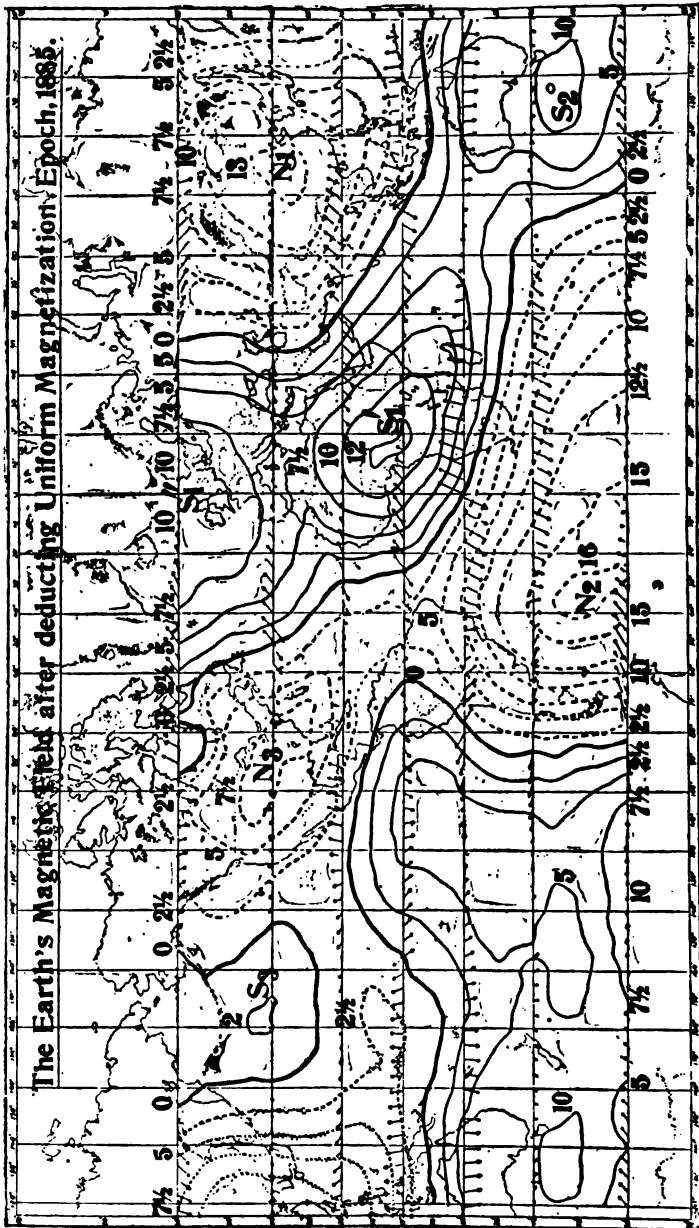

The curved lines are lines of equi-residual vertical forces. The arrows give the direction and relative intensity of the hor. component of the residual magnetic forces. The north end of a magnet is attracted over the region of the dotted curves, and the south end over the region of full curves. The vertical intensities are given in large figures in units of the second declinal. (From *Journal of Terrestrial Magnetism and Atmospheric Electricity*, Vol. IV, 1890.)

it is not a heterogeneous one, but, in general, remarkably systematic in its structure. There is, therefore, a very strong indication that it is produced by some distinct physical cause operating in the same general manner over the entire earth. The hope is thus clearly held out that we may still further resolve the residual field, starting with fundamental, physical causes.

My present belief is that the chief physical cause of the residual field is to be referred to the distribution of temperature within the stratum of the earth's crust here concerned.

There is a very remarkable correspondence between the principal features of the residual magnetic field and those exhibited on a chart of isabnormal temperatures. It is found that the earth as a magnet acts like any other magnet as regards application of heat. Thus, wherever the earth's surface is relatively warm, on the average for the year, there the magnetization of the earth shows a decrease; and where, on the other hand, it is relatively cold, there it suffers an increase. The comparison holds so far that it is possible to reproduce the residual magnetic field, in its general characteristics, with the aid of temperature charts.

The criticism has been made that this relation between residual magnetism and temperature distribution may only be an apparent one, since the latter referred to surface conditions, whereas the former pertained to strata at considerable depths below the surface. However, the isabnormal temperatures plotted were based on annual means; hence the effects due to annual variation and diurnal variation were eliminated. I am not aware that any one has given a physical explanation of the situations of the maxima and minima shown on an annual isanomalous temperature chart. Their annual positions are probably largely dependent on the radiation of the internal heat of the earth. We cannot say, as yet, at what depth the principal thermal features shown at the surface are eliminated; it is known that the isothermal surfaces in the interior conform with those of the surface to a considerable depth. In any case, there is no question that as land areas are pierced, a steady increase of temperature is encountered. Over oceanic areas, on the other hand, there is at first a decrease until nearly a zero temperature is reached at the ocean beds, and then, presumably, an increase as the penetration continues. So that we shall have temperature gradients along parallels of latitude down to a considerable depth.

I shall not discuss this matter further now, as it is being made the subject of a special examination. Many have surmised that

the distortion of the earth's magnetic field is to be attributed to the distribution of land and water; but the problem is to show in what manner the distribution causes the observed effects. The first attempt, as stated, will be to ascertain whether the cause is to be sought in the distribution of temperature in the upper stratum of the earth's crust, as produced largely by the distribution of land and water. The results of the decomposition have thus revealed one promising mode of attack of the problem as to the causes of the asymmetrical distribution of the earth's magnetism.

Another extremely interesting result is that a very close similarity is found to exist between the chart of the residual permanent magnetic field and that of the system of forces causing the diurnal variation of the earth's magnetism. The two magnetic systems are identical in their general characteristics except in one respect, viz., the first is to be referred to a system of magnetic forces in the earth's interior, whereas the second to a system outside, the relative positions of the poles being governed accordingly. Thus at Greenwich mean noon, for example, the north-end attracting pole of the first system would be about vertically below the south-end attracting pole of the second system, and the south-end attracting pole of the first would be about directly below the north-end attracting pole of the second system — this statement holding for the main transverse magnetization in each hemisphere.

There appears to be more than a chance connection in this relation, as is shown by the horizontal vector diagrams for various parallels as resulting from the two respective fields.

I have had the impression for some time that the earth's permanent magnetic field may play a very important part in the production of the diurnal variation field as observed on the earth's surface. No satisfactory explanation has as yet been given of the manner in which the peculiar magnetic system of forces causing the diurnal variation is actually produced. Schuster's first attempt at the construction of the equipotential lines of the diurnal variation field, based as it was on exceedingly meager data, was, nevertheless, remarkably correct in its general features, as shown by the recent more elaborate work of Fritsche. We, therefore, have now a fairly accurate map of this field.

The existence of some form of radiation from the sun which does not penetrate to the lowest strata of our atmosphere, and which is yet capable of deflecting magnetic needles on the earth's surface, appears to have been definitely proven by the recent magnetic ob-

servations during solar eclipses. It was furthermore shown that the eclipse magnetic variation was a phenomenon similar to the diurnal variation, and that it differed from the latter only in degree; the ranges in the declination variations, e. g., being proportional to the amounts of radiation cut off by the respective bodies — the moon and the earth.

It is known how a moving electrified particle will be deflected by a magnetic field, and how, in general, it will be made to travel in a spiral path whose axis is the line of magnetic force. It is possible now, that as a result of the combined action of the permanent magnetic field of the rotating earth and the electrified particles radiated by the sun, there is formed in the regions above us a secondary magnetic system precisely similar to that of the earth?

The physical analysis of the permanent magnetic field, in addition to furnishing a number of interesting results, thus leads us, in a seductive manner, to the consideration of forces and phenomena not hitherto associated with those of the permanent magnetic field. We are led to inquire as to the rôle played, in the economy of nature, by the magnetic energy stored up in the regions outside due to the earth's permanent magnetic field, in preventing certain solar radiations from reaching the lower strata of our atmosphere. And at this threshold it will be well for us to pause and defer further exploration to a more convenient time.

DISCUSSION.

CHAIRMAN WEBSTER: This very interesting communication of Doctor Bauer, which contains a great deal of new information, is now before the Section for discussion.

DOCTOR GLAZERBROOK: Mr. Chairman, your programme is too full and too important to allow of any lengthy discussion. At the same time I can hardly let the opportunity pass that I now have of congratulating Doctor Bauer on the importance and the value of the results that he is able to bring before this Congress, and of assuring him of the importance that we, in England, attach to his work on this subject.

Some of the results of Doctor Bauer's statements are sufficiently striking. I gather that he does not attach too serious a weight to the prophecy that in sixteen hundred years from now the earth will cease to be magnetic. The results of that are too terrible to contemplate. I also think that Doctor Bauer is an extremely bold man to bring forth a paper of this kind in an audience mainly composed of electrical engineers. I, for my own part, have taken a somewhat similar stand. I have ventured to insist that the study of terrestrial magnetism is of great importance, and that we

had some right to compensation and reward for the disturbance caused by traction currents. I am glad to say that those concerned in England have recognized that fact, and we hope in the course of the next year, or perhaps a little longer, to have our magnetic observatory on a site which I trust will for many years to come be free from the disturbances which now affect observations in the neighborhood of our great cities.

Doctor Bauer has spoken of the results which we should obtain from the antarctic researches of the German and our own English expeditions. I was in close communication with Captain Scott and his various officers before leaving England, and I have heard from them, as opportunity offered, as to the results of their work; arrangements are now being made for the reduction of the results of that expedition under the general supervision of the Committee of the Royal Society, in which we have the assistance of Doctor Chree and Captain Creak, whose names will secure general adhesion, and the results of this work will go far to justify the claim Doctor Bauer has made for further co-operation in investigating terrestrial magnetism over large areas, both of land and open ocean.

CHAIRMAN WEBSTER; I should like to ask whether these currents of air, as they go up or down, carry the electrical currents with them?

DOCTOR BAUER: It will be noticed that the result given is for the region of the earth from 60 degrees north to 60 degrees south. The computation can not be made over the entire earth, owing to the scarcity of reliable data for the regions beyond the two parallels of latitude mentioned. However, for the region considered, the total quantity of electricity is for the areas of low pressure, plus 829 amperes; whereas for the areas of high pressure, minus 636, hence nearly complete compensation, as far as the data will warrant drawing a definite conclusion.

When the attempt is made, therefore, to determine the existence of vertical electric currents from detailed magnetic surveys of restricted areas, it may be necessary to take into account the general meteorological conditions. This is a matter which requires further investigation. The investigations show that the effect of the value of the magnetic declination to be ascribed to vertical electric currents may amount in certain regions to as much as two-tenths of a degree. This answers the question put regarding the possibility of explaining some local disturbances observed in the State of Texas as due to such vertical electric currents. It is seen that the effects to be ascribed to such a cause are not large enough to explain the large local disturbances sometimes observed; the latter are to be referred, in general, to geological formations.

CHAIRMAN WEBSTER: It is very noticeable that the air, according to those results, carries a positive charge with it; that is to say, the current goes with the air. I understand that where there is an upward current of air there is an upward current of electricity.

Are there any further remarks upon this very interesting paper?

Dr. C. P. STEINMETZ: I should like to say that I have not much sympathy with the endeavor to keep electric railways from the vicinity of magnetic observatories, and so protect the observatories from stray electrical currents. Not that I don't appreciate the enormous value of these observations, but because I do not believe it possible. Any attempt to keep

the railways away would merely be temporary, because if they are not constructed this century they will be next century. In course of time the electric railway will approach and destroy the usefulness of the magnetic observatory. I believe you should select a place to erect your magnetic observatory where there would be no possibility of interference, for instance, by locating it on an island far from other islands or steamship routes. Then it may be possible to keep electric railways away from observatories, and, therefore, free from disturbances.

Other methods have been discussed, but I believe the only way you can really safeguard this most important—or one of the most important branches of investigation—is to look around and see whether you can not locate your observatory somewhere where there is no chance at any future time of interference; the location may not be convenient for the observer, but you will always find men who are willing to make some sacrifice in the interest of science.

DOCTOR BAUER: I question whether ever more care was taken in the selection of sites for magnetic observatories than for those of the United States. For example, the very suggestion made by Doctor Steinmetz as to the selection of an island was fully considered; thus in deciding upon the site for the observatory near Washington, I had in mind an island in the Chesapeake, but there we should have the difficulty of ready access to encounter. An observatory must be placed where the results may be readily available, and so that delicate instruments can be expeditiously and safely forwarded to and fro. There is, however, another consideration, viz.: the disturbing magnetic effect resulting from the too close approach of iron ships. For example, in the case of the Potsdam magnetic observatory, it is believed an effect is discerned, due to the turning of the iron dome of the astro-physical observatory.

In the case of the Cheltenham magnetic observatory, I trust that we shall be beyond the influences of electric car lines for some time to come. A region was selected which, besides meeting all of the other requirements, is also one where there appears to be very little inducement for introducing electric car lines.

CHAIRMAN WEBSTER: This subject certainly shows the conflict between pure scientific research and comfort. I am sure we are very much indebted to Doctor Bauer for this very interesting paper and discussion.

We have the very good fortune to have with us this morning a physicist of world-wide reputation, and of the greatest originality. I have the great pleasure of announcing that Doctor Arrhenius was yesterday elected the second honorary member of the American Physical Society, the first, Lord Kelvin, having been elected two years ago on his visit to this country.

Doctor Arrhenius read his paper on the "Electric Charge of the Sun."

ON THE ELECTRIC CHARGE OF THE SUN.

BY PROF. DR. SVANTE ARRHENIUS, *University of Stockholm.*

The chief forces which determine the motions of electrical bodies are due to the gravitation of their masses according to the law of Newton. But besides these forces, which tend to concentrate matter, there exist others of a repulsive nature, as Kepler observed regarding the comets' tails. As no other repulsive forces were known than those between similarly electrified bodies, it was supposed that these forces were of electric origin, and Zöllner, in particular, worked out this theory for explaining the form of the tails of comets.

These electric forces were, nevertheless, of a highly hypothetical nature, because no reason could be found why the sun and the particles of the comets' tails should be charged electrically. Astrophysicists were, therefore, gratified when a new repulsive force, namely that of the pressure of radiation, which is a consequence of the theories of Maxwell and Bartoli, was introduced for the explanation of the observed repulsions between celestial bodies. According to these theories, the radiation from the sun would be sufficient to exert a pressure against a totally reflecting spherical drop of 1.5μ diameter, which would balance its gravity if the drop had a specific weight equal to that of water. Drops of this magnitude ought, therefore, to swim in the atmosphere of the sun, just as if they had no weight. Bigger drops ought to fall down to the sun, and smaller ones to be repelled from it.

Schwarzschild has effected a calculation of the influence of the diffraction of light on these small drops. He showed that the repelling force compared with gravitation has a maximum if the circumference of the drop is just equal to the wave length of the radiation. Now the wave length of the maximal radiation of the sun is about 0.5μ . Therefore, the radius of the drop that is repelled with the greatest possible force compared with its weight would be about 0.08μ . If its specific weight were 1, the pressure due to the radiation of the sun would be about 19 times as great as the gravitational attraction of the sun. Taking into account the

composite nature of the sun's radiation, the repulsion of the drop sinks to about 10 times the gravitational attraction. This calculation is valid for a perfectly reflecting drop. For a perfectly black drop the repelling force is half as great. If we suppose the drop to consist of a non-metallic fluid, it would not be perfectly black, but only absorb a part of the sun's radiation. Most fluids absorb nearly perfectly the non-luminous radiation of the sun and partially reflect all rays incident on them. An appreciation of both these factors leads to the estimate that in this case the pressure of radiation is about 2.5 times greater than the gravitation of the drop of 0.08μ radius and specific gravity of unity.

Now, as C. T. R. Wilson showed, drops (of water) are more easily condensed on the negative ions of ionized air than on its positive ions. There is no doubt that the atmosphere of the sun is to a rather high degree ionized by the strong ultra-violet radiation of the sun (as Lenard's experiments indicate). Therefore, a far greater number of the drops condensed in the sun's atmosphere will carry negative electric charges than those carrying a positive charge. As these drops are repelled from the sun and meet the atmospheres of celestial bodies, e. g., the earth, they are retarded in their motion and cause the higher atmospheric strata to receive a negative charge, which, as it reaches a certain magnitude, is partially discharged, and in this manner causes the auroras and magnetic storms.

Now it is well known that these effects on the earth's atmosphere appear at a certain time-interval after the eruptions by which they are probably caused have been observed on the sun. Therefore, it is of great interest to calculate the time necessary for the transport of such a particle from the sun to the earth. This may easily be made by the following calculation:

We suppose that the particle has specific gravity 1 and moves under the influence of a radiation pressure which is double as great as its gravitation to the sun. Then the particle behaves just as if it were repelled from the sun by a force like that of the general gravitation. If v_1 and v_0 are the velocity of this particle at two different distances, r_1 and r_0 from the sun, the following equation holds good:

$$\frac{1}{2} v_1^2 - \frac{1}{2} v_0^2 = k \left(\frac{1}{r_1} - \frac{1}{r_0} \right)$$

where k is the gravitation constant multiplied with the sun's mass. The magnitude of this constant depends on the units selected of length and time. If we choose as unit of time the second and as

unit of length the solar radius ($= 691,000$ km), we may determine k from the fact that a mass falling from infinite distance without initial velocity into the sun reaches it with a velocity of 618 km.p.s.;

i. e., $v = \frac{1}{1118} \frac{\text{solar radius}}{\text{second}}$. Therefore, we have:

$$\frac{1}{2} \left(\frac{1}{1118} \right)^2 - 0 = k \left(\frac{1}{1} - \frac{1}{\infty} \right)$$

from which we deduce $k = \frac{1}{2} \left(\frac{1}{1118} \right)^2$.

If we now return to our particle that is driven away from the sun with a force equal to its own weight, we find for its velocity v at the distance r from the sun, if its initial velocity at the sun's surface ($r=1$) is zero, the following equation:

$$\frac{1}{2} v^2 = \frac{1}{2} \left(\frac{1}{1118} \right)^2 \left(1 - \frac{1}{r} \right)$$

or

$$v = \frac{dr}{dt} = \frac{1}{1118} \sqrt{1 - \frac{1}{r}}$$

From this we find by integration the time t , necessary for the particle's transport from $r=1$ to $r=r$

$$t = 1118 \int_1^r \frac{dr}{\left(1 - \frac{1}{r}\right)^{3/2}}$$

If we introduce the substitution $z = \left(1 - \frac{1}{r}\right)^{1/2}$, we find:

$$t = 2236 \int_0^z \frac{dz}{(1-z^2)^{3/2}} = 559 \left(\frac{1}{1-z} - \frac{1}{1+z} + \log_{\epsilon} \frac{1+z}{1-z} \right)$$

seconds.

Calculated by this formula, the time for moving one solar radius (from $r=1$ to $r=2$) is found to be 2375 seconds or 39.6 minutes. The time necessary for reaching the earth ($r = 149.5 \times 10^6$ km = 216 solar radii) is found to be 245,000 seconds = 68.7 hours.

Now we have found that the drops of specific weight 1 and of radius 0.08μ , which move with the greatest speed from the sun, are driven by a pressure of radiation about 2.5 times their gravitation to the sun. The total force moving them is, therefore, 1.5 times as great as supposed in the above calculation and, therefore, the time

for their motion between the sun and the earth will be only two-thirds of that calculated, i. e., 45.9 hours.

This figure agrees exceedingly well with that found by Riccò, 45.5 hours, for the difference in time between the passage of a great sunspot over the central meridian of the sun and the appearance of a magnetic storm on the earth.

Riccò also analyzes the results of Ellis, calculated by Maunder. From their data he concludes that a magnetic storm occurs on the average in 42.5 hours after the passage of the sunspot probably causing it, over the central meridian of the sun.

These figures of Ellis and Maunder give the mean value of the time for the transport of the particles from the sun to the earth. Their speed is evidently in a high degree dependent on their specific gravity. So, for instance, if this is only 0.6, corresponding to light hydrocarbons, the necessary time will be 2.1 times less than that calculated. And if their specific weight is about 2, corresponding to silicates found in meteorites, their speed will be only a third of that calculated. The calculation can, therefore, only indicate that the necessary time is just of the order of magnitude observed. Riccò has already noticed that the order of magnitude of the intervening time-interval calculated from the theory of the radiation pressure is the same as that which has been observed.

By the loss of negative electricity, the sun will get an ever-increasing charge of positive electricity. This will hold the negatively-charged particles back so that if the charge is strong enough, no more negatively-charged particles would leave the sun. The atomic charge, that is the smallest quantity of electricity, is calculated by Planck to be 4.7×10^{-10} electrostatic units. If we calculate the positive charge of one atom of hydrogen, we find a number of the same order of magnitude. One gram of hydrogen at 0 deg. C. and 760 mm pressure, fills 11,200 cc and has a charge of 96,500 coulombs or $28,950 \times 10^{10}$ electrostatic units. One cc at 0 deg. C. and 760 mm, contains 21×10^{18} molecules and 42×10^{18} atoms. The charge of the atoms in one cc hydrogen is 2.59×10^{10} electrostatic units.

Therefore, the charge of one atom is $\frac{2.59 \times 10^{10}}{42 \times 10^{18}} = 6.2 \times 10^{-10}$

electrostatic units. We may use the mean value 5.5×10^{-10} of these two values as a somewhat reliable quantity.

If now the charge of the sun were so great that the slope of potential reached one electrostatic unit, i. e., 300 volts per cm, the force

driving the unit charge, which a particle is supposed to carry back to the sun, is 5.5×10^{-10} dynes. A drop of the radius 0.08μ and the specific weight 1 has the weight 59×10^{-10} dynes at the sun's surface and its repulsive force according to the pressure of radiation is 2.5 times greater, i. e., 148×10^{-10} dynes. The difference of the pressure of radiation and the weight is 89×10^{-10} dynes, i. e., 16 times as great as the electric attraction. Therefore, if we suppose the electric charge of the sun to be so great that the slope of potential is 16 electrostatic units (or 4800 volts per cm) then no negatively-charged particles will move away from the sun. This is, therefore, a maximal charge which never can be reached, and probably the order of magnitude of the charge of the sun will be about a tenth of this, being greater in times of many sunspots, and less in times of sunspot minima.

The total charge of the sun, if the maximum value of slope of potential, 16 electrostatic units, were reached would be $16 \div 4\pi$ electrostatic units = 42×10^{-12} electromagnetic units per cm^2 or 2.3×10^{18} coulombs (enough for electrolyzing 240 tons of hydrogen) for the whole sun. This charge would soon be reached on the sun by emission of negative charges on all sides, if there was no afflux of negative electricity to it. The negatively-electrified drops repelled from the sun and the stars meet in the universe and form attracting centers which collect other negatively-electrified drops and form great complexes of matter, probably identical with the meteorites.¹ As the experiments of Lenard and Elster and Geitel show, negatively-charged bodies gradually lose their charge in the form of electrons under the influence of ultra-violet rays. These electrons wander through space and are attracted by the positively-charged suns.

It remains now to calculate the orbit of these electrons in order to determine under what circumstances they fall back into the sun. A particle that enters into the solar system from infinite distance with the initial velocity, v , describes a hyperbola around the sun as focus and with the semiaxis a , where

$$v^2 = 2.952 \times 10^{-4} \times \frac{1}{a}$$

1. The magnitude of the potential of these drops is $\frac{5.5 \times 10^{-10}}{8 \times 10^{-6}} = 7 \times 10^{-5}$ electrostatic units or 0.021 volts. By the agglomeration of many drops, the potential increases so for instance if 1000 drops unite, the potential increases to 2.1 volts. At first, after the union of many drops, the charge can disappear gradually under the influence of ultra-violet light. This probably causes the single drops which cannot gradually lose their charge to retain it.

if a is expressed in a unit equal to the radius of the earth's orbit and the unit of time is one day.

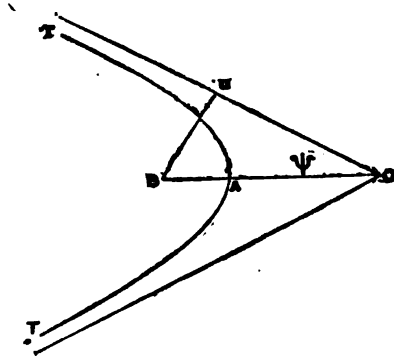

ORBIT. OF ELECTRIFIED PARTICLE.

If in the figure S represents the sun and TT' the hyperbolic orbit of the particle, then $SA = a$. If we call the distance su of the sun to the asymptote of the hyperbola $su = b$, and put the angle $SOU = \psi$, we get $SO = ae$, where e is the eccentricity of the hyperbola. Now $e \cos \psi = 1$ and, therefore, $ae \cos \psi = a$ or $OU = a$. Further, $ou = \sqrt{so^2 - su^2} = \sqrt{a^2 e^2 - b^2}$. If we call the perihelion distance $SA = d$, then

$$d + a = ae = \sqrt{a^2 + b^2} \text{ or } d = \sqrt{a^2 + b^2} - a.$$

If e is very nearly equal to 1, as in the cases which will be investigated below, we get:

$$d = a \left(1 + \frac{b^2}{2a} \right) - a = \frac{b^2}{2a}$$

and

$$b = \sqrt{2ad}.$$

If $v = 1$, i. e., 149.5×10^6 km in 86,400 seconds, or 1730 km in a second, we find $a = 2.5 \times 10^{-4}$ orbit radii, or 44,200 km. If, as in the experiments of Lenard, $v = 3 \times 10^7$ cm.p.s. = 300 km.p.s then a is $\left(\frac{173}{30}\right)^2$ times greater, or 1,470,000 km.

This is valid for heavy particles. In our case we have to regard the electric attraction of the sun. The charge of 1 gram cathodic rays is about 1000 times greater than that ($28,950 \times 10^{16}$ electrostatic units) of 1 gram of hydrogen. The weight of 1 gram at the sun's surface is 27.4 times greater than at the sur-

face of the earth, or 26,900 dynes. If the slope of potential in the neighborhood of the sun's surface is 1.6 electrostatic units per cm ($480 \frac{\text{volts}}{\text{cm}}$), a probable value found above, then the force acting on the charge, $28,950 \times 10^{13}$ electrostatic units, of 1 gram of cathode rays, is $46,320 \times 10^{13}$ dynes or 1.72×10^{13} times greater than the corresponding weight. For a cathode ray attracted by the sun, we have, therefore, to make $a = 1.72 \times 10^{13}$ times greater than calculated above, i. e., if its velocity is 3×10^7 cm.p.s., $a = 2,533 \times 10^{16}$ km = 268×10^4 light-years.

Now it is easy to calculate b , that is the distance of the sun from the orbit of the particle, if this were not altered by the attraction of the sun. We assume the value of d equal to the sun's radius 691,000 km, so that the particle is just caught by the sun. Then we find $b = \sqrt{2aa} = \sqrt{2} \times 2533 \times 10^{16} \times 691 \times 10^5 = 591.7 \times 10^{10}$ km = 0.626 light years.

As we see from these figures, b is very small compared with a , which we have assumed as the basis for the calculation.

The above calculation shows that in general, if the cathode rays have such a speed as those emitted by negatively-charged bodies under the influence of ultra-violet light in Lenard's experiments, they will be caught by the sun if they move in from space along a path less distant than 0.63 light years from the sun. This may be regarded as a mean value, some of the cathode rays moving with greater, others with less, speed. If the positive charge of the sun, i. e., its lack of negative electricity, is quadrupled, then b increases to the double, or the electrons caught in unit time — if they, as probably, are uniformly disseminated in space — increases to the quadruple quantity. In other words, the supply of negative electrons to the sun is proportional to its defect thereof. The mechanism regulating the electric balance of the sun is, therefore, of the most effective kind. The part of space which is drained, so to speak, of electrons by the sun reaches about the tenth part of the way to the nearest stars — our nearest star, α centauri, is about four light years distant from us.

By these means the supply of negative electricity to the sun is maintained so that the emission of negatively-charged particles by help of the radiation pressure can ever go on and follow the variations of its eruptive activity, measured by the number of sun-spots. Therefore, also the number of auroras and of magnetic storms as well as the rate of the daily variation of the magnetic

declination, which phenomena I suppose to be caused by the number of negatively-charged particles coming from the sun to the earth's atmosphere, show the same periodicity as the sunspots. The daily variation of the magnetic declination being about double as great at sunspot maxima as at sunspot minima seems to indicate that the charge of the upper atmosphere of the earth produced by the charged particles from the sun changes about in the proportion 2 to 1 in the sunspot period of 11 years.

It is also evident that if the charged particles had much smaller dimensions than the particles treated above, so that the pressure of radiation had no sensible influence on them according to Schwarzschild's calculations, they would be held back to the sun by the strong electric forces. Also if they were thrown out at the various eruptions causing the metallic protuberances, they would soon be carried back to the sun and never reach the earth. On this ground the hypothesis advanced by Birkeland and Goldstein that the charged particles reaching the earth from the sun consist of cathodic rays cannot apparently be sustained. Evidently there must be other forces that carry away the electrical charges from the sun than those which carry them back. Otherwise, a stationary condition would soon enter beyond which particles would no longer leave the sun.

DISCUSSION.

DOCTOR BAUER: Mr. Chairman, I have listened to the paper of the very distinguished speaker with a great deal of interest and profit. It must be regretted that some of our eminent physicists in this country have not been induced to likewise take up some of the problems in the field of terrestrial and cosmical physics where there are "many worlds to conquer." Such investigations as the one we just have had the privilege of listening to are becoming more and more of the greatest interest and importance.

I believe there is no doubt that we are getting radiations from the sun which affect the magnetic needle and which do not penetrate far into the atmospheric regions except near the polar regions. This was shown very clearly by the magnetic effect successfully observed during the recent solar eclipses.

Since the source of magnetic storms is under consideration, it may be of interest to refer briefly to the magnetic disturbance which occurred coincident with the eruption of Mt. Pelée on May 8, 1902. This eruption took place as nearly as can be ascertained at 7.52 May 8th, St. Pierre local mean time; that is to say, the clock on the town hospital was stopped at that time. Now, from comparison of the magnetic observations all over the globe, the magnetic disturbance began at 7.54, as referred to St. Pierre time. This disturbance began practically at the same time over the whole

earth. If we analyze the magnetic disturbance, a surprising result is reached, namely, that the forces which produced the magnetic disturbance appear to have had their seat not chiefly below the earth's surface, as one might have supposed from the observed coincidence with the eruption, but on the contrary, chiefly in the regions above us. Apparently this terrestrial explosion brought about a disturbance in the electrification of the upper regions which in turn affected the magnetic needle.

DOCTOR STEINMETZ: I desire to correct a misunderstanding of Doctor Bauer. I do not care to go on record as sympathizing with the destruction of magnetic observatories by electric railroads. My position is this: that now, while there are still some places on the earth where electric railroads have not encroached, we ought to select those places which can never be encroached upon. It is not the electrical engineer who encroaches upon the observatory; it is the layman, the businessman, the politician, who wants a railroad and does not know enough to appreciate the value of magnetic observation, but who has the financial and the political power to get the railroad. We don't want to see the observatory destroyed; but, whether we like it or not, powers greater than we can control will destroy them, and, therefore, I would like to see them put in a place where they can not be destroyed.

PROFESSOR RUTHERFORD: I need hardly express with what great pleasure I listened to Doctor Arrhenius's address. I think the idea on which he has worked out the result that the sun must have a positive charge, and the method by which this positive charge is maintained is a very striking one. Of course, the value of such a deduction depends upon the assumptions upon which it is based. I think that his analysis of the assumptions shows that they are all eminently reasonable. Doctor Arrhenius supposes that electrons are ejected at the rate of about 3×10^7 cms a second. We have every reason to believe that hot bodies generally do emit electrons at about that speed, and in addition, if we suppose that there is any radioactive matter present, there are others thrown off at a still faster rate. I think there is no doubt that there must be electrons projected from the sun at about the velocity which Professor Arrhenius supposes.

I was very much struck with the ingenious idea by which the sun is supposed to maintain its positive charge. There is the steady drain due to the throwing off of electrons, and the steady withdrawal of electrons from space to supply the loss: so that practically the sun maintains a steady charge and at the same time we have a very great supply of electrons for the earth.

We only get the effect of the outside rim of the sun, but knowing, as we do, its very high temperature, I think it is surprising that we do not get larger effects on the earth in the way of magnetic disturbances than have been observed. I think it is rather remarkable that the effects due to the sun are so comparatively small as we believe them to be.

DOCTOR ARRHENIUS: It is very probable that you have heard from the last speaker that the magnetic phenomena that I spoke of depend upon the currents in the higher air. This also is a fact that is demonstrated by this chart here (indicating chart on wall). It is possible to explain the deviation of the magnetic needle under the influence of the sun by

supposing there are two great cyclones, one on the north side and the other on the south side, a little before 12 o'clock—about 11 o'clock. Then we have currents that come back on this and on that side. These currents of electricity which are probably connected with currents of the air, would therefore, according to this explanation, carry just double as much electricity—the quantity of charge in the air, would be double as great in times of many sunspots as in time of few sunspots.

If the number of particles is so small in the neighborhood of the sun, where they certainly are concentrated to a very high degree, it is easy to understand that the number of particles in the neighborhood of the earth, so very much further from the sun, will be extremely little, and although they carry a very large charge, yet, from the relatively small number of particles, their influence could not be greater than that of the sun. The common remark is that the sun could not have such a great influence upon the magnetism of the earth as it has.

I spoke in the Royal Society upon similar subjects, and Lord Rayleigh was so kind as to say that he would give up his position—namely, that it was impossible to suppose that the sun could have any influence upon the magnetism of the earth, as soon as this explanation of the charged particles was given.

The common remark against the sun's influence is that it could not be so great as it is; but that was based upon the hypothesis that the magnetic influence would be a direct one. By the help of such little charged particles, it is possible to obtain an influence of the magnitude that is observed.

This whole calculation of the charge of the sun is of course a preliminary one; but someone must take the first steps, and then the critic will come and make some alterations, and at the end we will have a good idea of the quantity of the charge.

This charge of the sun I suppose is one of the most fundamental constants of nature influencing upon the earth's magnetic and electric phenomena.

DOCTOR BAUER: I would state that the effect during the storm of October 31, 1903, was extremely large. The total change in the horizontal intensity as actually observed at the Cheltenham Magnetic Observatory was one-thirty-ninth ($1/39$) part of the absolute value; owing to the violence of the storm, the recording spot of light passed beyond the limits of the recording sheet, the general indications being, however, that the total fluctuation may have amounted to as much as one-twenty-sixth ($1/26$) part of the absolute value of the horizontal intensity. The total change in the magnetic declination was ninety-seven minutes of arc ($97'$). It took the earth about two weeks to recover from the effect of this storm, the values of the horizontal intensity throughout the period being too low.

With regard to the field of force causing the diurnal variation, referred to by Professor Arrhenius as due to electric currents in the upper regions of the atmosphere, associated with the general atmospheric circulation, it may be an interesting inquiry whether, starting with such electrically charged particles as Professor Arrhenius speaks of, and considering the

actions taking place when they come within the influence of the lines of force of the earth's magnetic field, whether a system of forces can be deduced which will account if not wholly, at least in part, for the observed diurnal variation. There is namely a remarkable similarity between the earth's permanent residual magnetic field as exhibited in my paper and the field of force causing the diurnal variations, as first mapped out by Schuster.

PROFESSOR STEINMETZ: I would like to ask whether the cause of the relatively low effect exercised by the sun upon the earth, magnetically and electrically, may not be due to the feature that this effect is exerted not by the condition of the sun, but by a change of the condition, and even during very great solar activity, the area and the extent of the storm is relatively small, compared to the whole sun.

DOCTOR ARRHENIUS: The disturbances on the sun are not so very great. There are very different calculations on that. It is the change which produces the actions upon the earth, and the change is never so great as the total quantity itself. It is very difficult to say how great the change is, but I might say a third part, or something like that. In regard to the faculae, one finds that a very great part of the sun's surface is in an active state, and may have an influence upon the other planets.

SLOW TRANSFORMATION PRODUCTS OF RADIUM.

BY PROF. E. RUTHERFORD, *McGill University.*
Delegate of the Royal Society of Canada.

It has been previously shown¹ that radium undergoes disintegration through a series of well-marked stages. The radium, first of all, produces the radium emanation, and this in turn is transformed into an active deposit which behaves as a solid and gives rise to the phenomena of excited activity. I have recently shown that this active deposit undergoes three further rapid transformations.² For convenience, the products in the active deposit will be termed radium *A*, radium *B*, and radium *C*, respectively.³ The change from *A* to *B* is accompanied by α rays alone, the change *B* into *C* is a rayless change, while the change *C* into *D* gives rise to α , β and γ rays. The time *T* for each of the products of radium to be half transformed is shown in the following table:

	<i>T</i>	Rays.
RADIUM		α rays
↓		
RADIUM EMANATION	4 days	α rays
↓		
RADIUM A	3 minutes	α rays
↓		
RADIUM B	21 minutes	no rays
↓		
RADIUM C	28 minutes	α , β , γ
↓		

The changes in radium are not, however, completed at this stage, for it will be shown that there is very strong evidence that there are at least two more slow transformations. M. and Mme. Curie⁴ observed that a body exposed in the presence of radium

1. Rutherford and Soddy. *Phil. Mag.*, April and May, 1903.
 2. Bakerian Lecture. Roy. Soc., Lond., 1904.
 3. The term, emanation *X*, which I previously employed to designate the matter, radium *A*, is not very suitable and I have discarded it in favor of the present nomenclature, which is simple and elastic.
 4. *Thèses présentées à la Faculté des Sciences, Paris, 1903*, p. 116.

emanation did not, after removal, completely lose all its activity. A residual activity always remained which they state was of the order of $1/20,000$ of the initial activity. It will be seen, however, later that the magnitude of this residual activity depends not only on the amount of emanation to which the body has been exposed, but also on the time of exposure. For an exposure of several hours, the residual activity is less than $1/1,000,000$ of the activity immediately after removal. Giesel⁵ also observed that a platinum wire, after exposure to the emanation, showed residual activity which, he states, consists only of α rays.

An account will now be given of some investigations made by the writer on the nature of this residual activity and the chemical properties of the active matter itself. It is first of all necessary to show that the residual activity arises in consequence of a deposit of radioactive matter, and is not due to some action of the intense radiations to which the body made active has been subjected.

The inside of a long glass tube was covered with equal areas of thin metal, including aluminum, iron, copper, silver, lead, and platinum. A large amount of radium emanation was introduced into the tube and the tube closed. After seven days, the metal plates were removed, and, after allowing two days to elapse for the ordinary excited activity to disappear the residual activity of the plates was tested by an electrometer. The activity of the plates was found to be unequal, being greatest for copper and silver and least for aluminum. The activity of copper was twice as great as that of aluminum. After standing for another week, the activity of the plates was again tested. The activity of each had diminished in the interval to some extent, but the initial differences observed had to a large extent disappeared. After reaching a minimum value, the activity of each plate slowly but steadily increased at the same rate. After a month's interval, the activity of each of the plates was nearly the same and over three times the minimum value. The initial irregularities in the decay curves of the different metals are, in all probability, due to slight but different degree of absorption of the radium emanation by the metal plates, the absorption being greatest for copper and silver and least for aluminum. As the occluded emanation was slowly released or lost its activity, the activity of the metal fell to a limiting value.

5. *Berichte d. Deutschen Chem. Ges.*, p. 2368, 1903.

The absorption of the radium emanation by lead, paraffin, and caoutchouc was some time ago observed by Curie and Danne.⁶ The residual activity on the plates comprised both α and β rays, the latter being present, in all cases, in very unusual proportion. The equality of the activity and the identity of the radiations emitted from each plate shows that the residual activity is due to changes of some form of matter deposited on the plates, and that it cannot be ascribed to an action of the intense radiations; for, if such were the case, it would be expected that the activity produced on the different plates would vary not only in quantity but in quality. This result is confirmed by the observation that the active matter can be removed from a platinum plate by solution in sulphuric acid, and has other distinctive chemical and physical properties.

The variation of the residual activity with time will first be considered. A platinum plate was exposed in the presence of the radium emanation for seven days. The amount of emanation initially present was equal to that obtained from about 3 mg of pure radium bromide. The plate immediately after removal gave a saturation current, measured between parallel plate by a galvanometer, of 1.5×10^{-7} amperes. Some hours after removal, the activity decayed according to an exponential law with the time, falling to half value in 28 minutes. Three days after removal the active plate gave a saturation current measured by an electrometer of 5×10^{-12} amperes, i. e., $1/300,000$ of the initial activity. The activity was observed to increase steadily with the time. The results are shown in Fig. 1, where the time is reckoned from the middle of the time of exposure to the emanation.

The curve is a straight line passing through the origin. The activity increases uniformly with the time for the interval of two months over which the observations have extended.

Some results indicate that this steady increase with time continues for at least nine months. The emanation from 30 mg of radium bromide was condensed in a glass tube, which was then sealed. After a month's interval, the tube was opened and dilute sulphuric acid was introduced. The acid dissolved the active residue deposited on the tube. On driving off the sulphuric acid by heat, a radioactive deposit was obtained. The first determination of the activity of this residue was made about six weeks

6. *Comptes Rendus* 136, p. 364, 1903.

after the introduction of the emanation. The activity, eight months later, was found to be about seven times the initial value. The results could not be very accurately obtained, as a portion of the activity had been removed in the interval by a bismuth rod placed in a solution of the active matter. The result, however, indicated that the activity had steadily increased over the period of nine months.

Radiations from the Active Matter.

The residual activity consists of both α and β rays, the latter being present initially in an unusually large proportion. The proportion of α to β rays from the platinum plate, one month

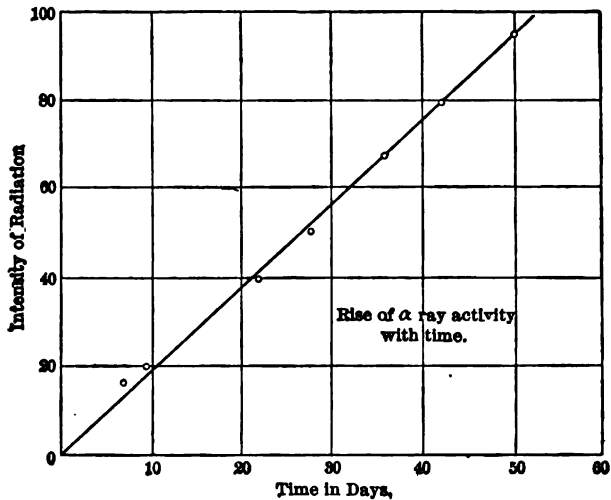

FIG. 1.

after removal, was at least 50 times as great as from a thin film of radium bromide in radioactive equilibrium. Unlike the α ray activity, the activity, measured by the β rays, remains constant, and in consequence, the proportion of β to α rays steadily decreases with the time. The experiments showed that the intensity of the β rays did not vary much, if at all, over a period of nine months. The want of proportionality between the α and β rays shows that the two types of rays arise from different products. This conclusion is confirmed by experiments, now to be described, which show that the products giving rise to α and β rays can

be temporarily separated from one another by physical and chemical means.

Effect of Temperature on the Activity.

An active platinum plate was exposed to varying temperatures in an electric furnace and the activity tested after exposure at atmospheric temperature. Four minutes' exposure in the furnace, first at 430 deg. C. and afterward at 800 deg. C., had little, if any, effect on the activity. After four minutes at 1000 deg. C., the activity decreased about 20 per cent, and a further exposure of eight minutes at a temperature of about 1050 deg. C. almost completely removed the α ray activity. The activity measured by the β rays was, on the other hand, not appreciably changed by the high temperature. Further heating, however, at a still higher temperature, caused a decrease of the β ray activity, showing that the β ray product was also volatile. These results show that the active matter consists of two kinds. The part which emits β rays is non-volatile at 1000 deg. C., but the other part which emits α rays is almost completely volatilized at that temperature.

Separation of the Constituents by Means of a Bismuth Plate.

The active matter of slow decay was obtained in solution by adding dilute sulphuric acid to a glass tube in which the emanation from 30 mg of radium bromide has been stored for a month. The solution showed strong activity and gave out both α and β rays, the latter, as in other cases, being present in an usually large proportion.

When a polished bismuth disc was kept for some hours in the solution, it became strongly active. The active matter deposited on the bismuth gave out α rays, but no trace of β rays. After several bismuth discs had been successively left in the solution, the active matter, which emits α rays, was almost completely removed. This was shown by evaporating down the solution after treatment. The β ray activity remained unchanged, but the α ray activity had been reduced to about 10 per cent of its original value. The active matter deposited in the bismuth does not appreciably change in activity in the course of one month, and some observations point to the conclusion that there is not much change in five months. The observations in the latter case were, however, not precise enough to be sure that there was not a

small percentage variation during that time. Experiments are now in progress to examine, with accuracy, the activity of the bismuth plate from time to time, and it is hoped that observations extending over the ensuing year will fix the rate of decay of this product, provided the rate of change is rapid enough to be measurable in a year's interval. The results obtained in this way are in agreement with those deduced by heating the active deposit to a high temperature. The active deposit contains two kinds of matter, viz.:

1). A product which gives out only β rays, soluble in sulphuric acid but non-volatile at 1000 deg. C. and is not deposited on bismuth.

2). A product which gives out only α rays, soluble in sulphuric acid, volatile at 1000 deg. C., and is deposited from a solution on bismuth.

Explanation of the Results.

We have seen that the α ray activity *increases* if the β ray product is present, but remains sensibly constant or changes very slowly if the α ray product is removed from the β ray product by the action of a bismuth plate. The β ray activity remains sensibly constant independently of whether the α ray product is present or not. These results show that the β ray product is the parent of the α ray product, for the amount of the latter steadily increases if the β ray product is present, but remains sensibly constant over the period of several months if separated from the β ray product. The amount of residual activity from the radium emanation depends on the amount of emanation present and the time of exposure to the emanation. These results show that the active deposit of slow decay is a decomposition product of the emanation and, since the first three transition products of the emanation, viz.: radium *A*, radium *B*, and radium *C* have been carefully analyzed and shown to be consecutive, it is natural to suppose that the matter of slow rate of change is a product of the last rapid change in radium *C*. Following the nomenclature suggested, radium *C* gives rise to the β ray product which will be called radium *D*, while radium *D* changes into the α ray product which will be called radium *E*. The product radium *D* give out only β rays. The transition products of the disintegration of radium are shown diagrammatically in Fig. 2.

No further changes have so far been observed. The active solution of radium *D* and *E* was tested to see if an emanation were present. A trace of the radium emanation was always observed but this was probably due to slight trace of radium carried over into the emanation vessel. This point is, however, under further investigation.

Theory of Two Successive Changes.

In all cases of radioactive change that have been examined, the amount of unchanged matter N_t present at any time t , is given by $\frac{N_t}{N_0} = e^{-\lambda t}$, where N_0 is the amount initially present and λ is the constant of change. Differentiating, $\frac{dN_t}{dt} = -\lambda N_t$, or the rate of change is always proportional to the amount present.

Suppose that P_0 particles of the product radium *D* are deposited during the time of exposure to the emanation. This time is sup-

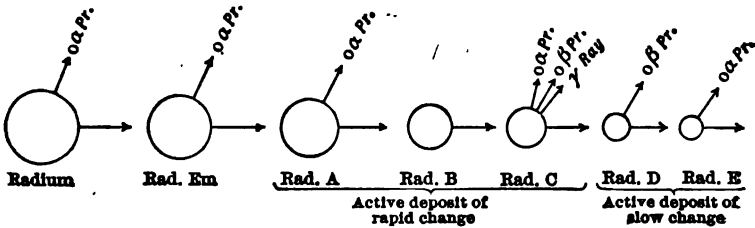

FIG. 2.

posed to be so short that the amount of change of radium *D* during the time of exposure is very small.

Let P = number of particles of matter radium *D* present at any time.

Q = number of particles of radium *E* present at any time.

λ_1 = constant of change of radium *D*.

λ_2 = constant of change of radium *E*.

Then $P = P_0 e^{-\lambda_1 t}$.

As the matter *D* changes into *E*, the value of Q at first increases. The increase dQ in the time dt is given by the difference between the number of particles of *E* ($\lambda_1 P$) supplied by the change of *D* into *E*, and the number of *E* ($\lambda_2 Q$) which change into *F*.

Then $dQ = \lambda_1 P dt - \lambda_2 Q dt$

$$\text{and } \frac{dQ}{dt} = \lambda_1 P_0 e^{-\lambda_1 t} - \lambda_2 Q.$$

The solution of the equation is of the form

$$Q = a e^{-\lambda_1 t} + b e^{-\lambda_2 t}.$$

Since $Q = 0$ when $t = 0$, we have

$$a = -b = \frac{\lambda_1}{\lambda_2 - \lambda_1} P_0$$

$$\text{and } Q = \frac{\lambda_1 P_0}{\lambda_2 - \lambda_1} (e^{-\lambda_1 t} - e^{-\lambda_2 t}).$$

For small values of t , $Q = \lambda_1 P_0 t$, i. e., the value of Q increases proportionately with the time. The value of Q passes through a maximum at a time T given by $e^{(\lambda_2 - \lambda_1)T} = \frac{\lambda_2}{\lambda_1}$ and then decreases.

The variation of P and Q with the time is shown graphically in Fig. 3.

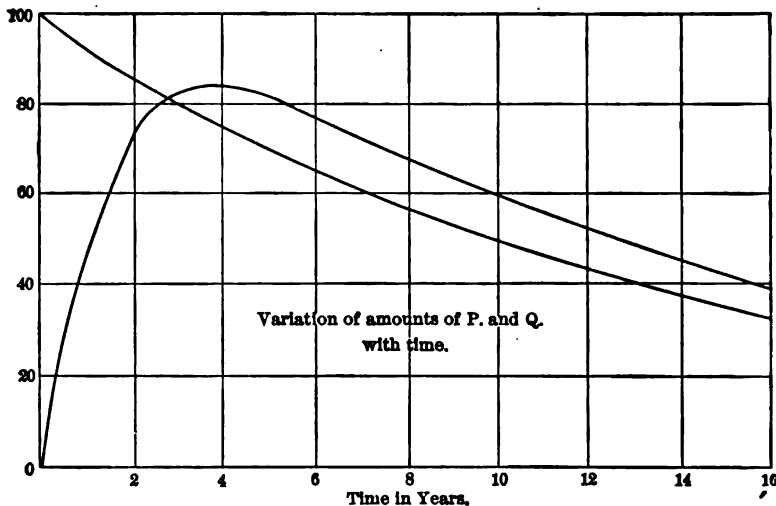

FIG. 3.

For the purpose of illustration, the curve is drawn to scale on the supposition that half of the matter D is transformed in 10 years and half of E in one year. The ordinates represent the relative number of atoms P and Q present at any time.

The initial increase of the α ray activity with the time is thus in agreement with the view that radium E (which emits only α rays) is produced from radium D . The time of observation (two months) has not yet been long enough to obtain more than the initial part of the α ray curve. The results, however, show that an interval of two months is very short compared with the time required for the product D or E to be half transformed.

Although the times of observation have been too short to experimentally determine either the value of λ_1 or λ_2 , it is possible, on certain assumptions, to form a rough estimate of these values.

It has been experimentally observed that each of the products of radium which emit α rays supplies about an equal proportion of the activity of radium, when in radioactive equilibrium. Since when equilibrium is reached, the same number of particles of each of the successive products must break up per second, this is an expression of the fact that every atom of each product breaks up with the expulsion of an equal number (probably one) of α particles. Now radium D is directly derived from radium C and, since the rate of change of D is very slow compared with that of C , the number of particles of D initially present must be very nearly equal to the number of particles of radium C which break up during the time that radium D is being formed. Now, suppose that each atom of radium C and D emits one β particle with the same velocity. The ionization produced by each particle will be the same under the same experimental conditions and the integrated value of the saturation current due to the β rays over the time that the body is exposed to radium C must equal the corresponding integrated value for the β rays during the life of radium D . Suppose, for example, that a quantity of emanation is introduced into a glass tube and left to stand for a month. During that interval the emanation has nearly all been transformed. The activity due to the β rays from it will reach a maximum several hours after the introduction of the emanation and will then decay with the time falling to half value in four days. Let i_1 be the maximum saturation current due to the β rays measured in a suitable testing vessel. The total quantity Q_1 of electricity passing between the plates of the testing vessel during the life of the emanation is approximately given by

$$Q_1 = \int_0^{\infty} i dt = \int_0^{\infty} i_1 e^{-\lambda t} dt = \frac{i_1}{\lambda}$$

where λ is the constant of change of the emanation.

In a similar way if i_2 is the initial current due to the β rays from the radium D deposited in the tube (measured under identical experimental conditions) the corresponding value of $Q_2 = \frac{i_2}{\lambda_1}$ where λ_1 is the constant of change of D .

Since by hypothesis $Q_1 = Q_2$

$$\frac{\lambda_1}{\lambda} = \frac{i_2}{i_1}$$

The ratio $\frac{i_2}{i_1}$ is determined experimentally, and since λ for the emanation is known, λ_1 is determined.

The details of the experiments by which the ratio i_2/i_1 was determined need not be given here. It was deduced on the above assumption, that half of the matter of radium D should be transformed in 40 years. In a similar way the total number of α particles expelled from radium C during the time radium D was being deposited must equal the number of α particles expelled from radium E during its life, supposing that there is only one change which gives rise to α rays. Assuming for the moment that the α ray activity, observed for the active deposit of 10 months' old, decayed from that time according to an exponential law, it was calculated that the period of the change could not be longer than 80 years. If the α ray change has a period short, compared with the β ray change, the α ray activity will finally decay at the same rate as the β ray activity (compare curves, Fig. 3). These two computations will agree if it is supposed that the α ray activity increases to twice the value observed after an interval of 10 months and then decays with the time according to the period of the β ray change. This would fix the period of the α ray change as about one year. When the α ray activity reaches its maximum value, it is to be expected on this view that the ratio $\frac{\alpha}{\beta}$ should be the same as for the product radium C . This is, however, somewhat at variance with experiment; for the 10 months' old deposit has about the same ratio $\frac{\alpha}{\beta}$ as radium C , while on the above computation the ratio $\frac{\alpha}{\beta}$ should only be one-half of that value. This difference may possibly be due to radium E undergoing a further change, giving rise to α rays, which has not so far been detected. In these calculations, it has been assumed that the α and β particles given out in these slow changes produce the same ionization as the corresponding

particles from radium C. There is no doubt, however, that this is not realized in practice. The β rays of radium D are slightly less penetrating than those of radium C, while the α rays of radium E have only about half the penetrating power of those of radium C. Our knowledge of the mechanism of absorption in matter is, however, too imperfect to correct for these differences with certainty.

The above methods of calculations, though somewhat complicated, certainly serve to give the right order of magnitude of the periods of the two changes. It will be shown, too, that the calculated periods agree approximately with the amounts of radium D and E present in old samples of radium. The chief uncertainty in the methods of calculation lies in the difficulty of ascertaining the relative electrical effect produced by the α and β particles compared with those emitted from radium C.

The time T required for each transition product of radium to be half transformed is shown in the following table:

Transition products of radium.	Time T to be half transformed.
Radium	about 1000 years.
↓	
Emanation	4 days.
↓	
Radium A	3 mins.
↓	
Radium B	21 “
↓	
Radium C	28 “
↓	
Radium D	about 1 year.
↓	
Radium E	about 10 years.
↓	

Experiments with Old Radium.

Since the substance radium D is produced from radium at a constant rate, the amount present mixed with the radium will increase with its age. I had in my possession a small quantity of my first specimen of impure radium chloride, kindly presented to me by

Professors Elster and Geitel four years ago. The amount of radium *D* present in it was tested in the following way: The substance was dissolved in water and kept continuously boiling for a period of about six hours. Under these conditions the emanation is removed as rapidly as it is formed and the β rays from the radium, due to the product radium *C*, practically disappear. A newly-prepared specimen of radium bromide under these conditions retains only a fraction of 1 per cent of its original β radiation. The old radium, however, showed (immediately after this treatment) an activity measured by the β rays of about 8 per cent of its original amount. The activity could not be reduced any lower by further boiling or aspiration of air through the solution. This residual β ray activity was due to the product radium *D* stored up in the radium. It could not have been due to β rays from radium *C*, since there was a distinct difference in penetrating power for the two kinds of β rays. The β ray activity due to radium *D* was thus about 9 per cent of that due to radium *C*. Disregarding the differences in the absorption of the β rays, when the activity of the product *D* in radium reaches a maximum value, the β ray activity due to it should be the same as that due to *C*. Since *D* is half transformed in 40 years, the amount present in the radium after four years should be about 7 per cent of the maximum amount, i. e., it should show a β ray activity of about 7 per cent of that due to radium *C*. The observed and calculated values (7 and 9 per cent respectively) are thus of the same order of magnitude. The amount of β rays from radium *D* present in pure radium bromide about one year old was about 2 per cent of the total.

The amount of radium *E* present in old radium was measured by observations of the activity imparted to a bismuth disc left for several days in the solution. Radium *E* is not deposited to an appreciable extent on the bismuth from a water solution of radium bromide. If, however, a trace of sulphuric acid is added to the solution, the radium *E* is readily deposited on the bismuth. The addition of sulphuric acid to the radium solution practically effected a separation of radium *D* and *E* from the radium proper; for the latter was precipitated as sulphate and the products *D* and *E* remained in solution. After filtering, the solution contained a greater proportion of the products *D* and *E* and very little radium.

The ratio $\frac{\alpha}{\beta}$ for the old radium was found to be about twice that observed for radium *C*. This result is in agreement with the deduc-

tions made in the calculations of the periods of the changes, for it can be theoretically shown that the amounts of *D* and *E* in the radium continue to be approximately proportional to one another after about 5 years' production, assuming the periods of the changes are 1 and 40 years respectively.

The amounts of radium *D* and *E* observed in the old radium are thus in good agreement with the results deduced from other data.

Variation of the Activity of Radium with Time.

It has long been known that the activity of freshly prepared radium increases at first with the time and reaches a maximum value after about an interval of one month. The results, already considered, show that there is a further slow increase of activity with the time. This is the case whether the activity is measured by the α or β rays. After a lapse of about 200 years, the amount of the products radium *D* and *E* will have practically reached a maximum value. The same number of atoms of each of the products *C* and *D* will then break up per second. If each atom of these products in disintegrating throws off an equal number (probably one) of β particles, the number of β particles thrown off per second will be twice as great as for the radium a few months old. The number will increase at first at the rate of about 2 per cent a year.

Similar considerations apply to the α ray activity. Since, however, there are four other products of radium beside radium itself which expel α particles, the number of α particles emitted from old radium will not be more than 25 per cent greater than the number from radium a few months old. The activity measured by the α rays will thus not increase more than 25 per cent and probably still less as the α particles from radium *D* probably produce less ionization than the α particles expelled from the other radium products. It is probable that half of the radium itself is transformed in about 1000 years. The activity of radium will consequently rise to a maximum after 200 years and then slowly die away with the time.

Products in Pitchblende.

The products radium *D* and *E* must be present in pitchblende in amounts proportional to the quantity of radium present and should be capable of separation from the mineral by suitable chemical methods. The radioactive properties of these substances, if obtained in the pure state, is summarized below.

Radium D.

The product immediately after separation should emit only β (and probably γ) rays. The β ray activity should decay to half value in about 40 years. In consequence of the change of D into E , the latter of which gives out α rays, the α ray activity will increase for a few years, pass through a maximum and then decrease with the time and fall to half value in about 40 years. Since the rate of change of D is about 25 times as fast as radium itself, the activity on separation, measured by the number of electrons expelled per second, should be 25 times as great as from an equal weight of radium. The α ray activity produced in it should any time be capable of separation by adding a bismuth plate to a solution of the substance.

Radium E.

The substance should emit only α rays and its activity should fall to half value in about one year. Since its rate of change is about 1000 times as great as radium, the substance, weight for weight, should emit about 1000 times as many α particles as freshly prepared radium, and about 250 times as many as from radium about one month old. The activity measured by the electric method will probably be about 100 times as great as that of pure radium.

It is now necessary to consider the question whether the substances radium D and E have been previously separated from pitchblende and are known by other names. In regard to radium D , there is some doubt whether it has been previously separated. It is possible that it is the radioactive constituent present in the radio-lead of Hoffman, for he states that this substance emits a large amount of β rays. On the other hand, the radio-lead, prepared by other observers, lost its activity rapidly with the time.

In regard to radium E , I think there is little doubt that it is the radioactive constituent present in the so-called radio-tellurium of Marckwald.⁷ It will be recalled that Marckwald obtained a deposit of radioactive matter on a bismuth plate introduced into a solution of pitchblende. This active bismuth gave out only α rays. The active matter was associated with tellurium and was in consequence called radio-tellurium. In later observations Marckwald has shown that tellurium is merely an impurity and has devised a method of concentrating the radioactive matter.

7. *Berichte d. Deutschen Chem. Ges.*, p. 2285, 1902.

The radioactive constituent in radio-tellurium and radium *E* are very analogous in chemical and radioactive properties, for both emit α rays and both are deposited on a bismuth plate introduced into the active solution. In addition, I have found that the α rays from the two substances are identical in their power of penetration through aluminum. The radio-tellurium was obtained from Dr. Sthamer of Hamburg in the form of a thin film of the active matter deposited on the surface of a polished bismuth plate. I was unable to detect any difference in the penetrating power of the rays from radium *E* and radio-tellurium although the intensity of the radiation was reduced to a few per cent by aluminum screens. It is well known that the α rays from most of the radioactive products differ in penetrating power and the identity of the α rays of radium *E* and radio-tellurium in this respect is a strong indication that the radioactive matter is the same in both cases. The agreement of the absorption of the rays, together with the similarity of its radiations and chemical behavior, affords very strong evidence in favor of the identity of the two products. If this is the case, the activity of the radio-tellurium must decay to half value in about one year.

It is natural here to consider the question whether the product radium *E* is also identical with the polonium discovered by Mme. Curie. Each acting constituent attaches itself to bismuth and emits only α rays. The test of penetrating power of the rays cannot be applied since the polonium, as commercially sold, is usually mixed with bismuth and not, as in the case of Marckwald's radio-tellurium, deposited in a thin film on the surface. The activity observed at the surface is thus due to α rays, which have already decreased in penetrating power due to their passage through different thicknesses of bismuth. The α rays from polonium, in consequence, appear to be more readily absorbed than those from radium *E* but it is not unlikely that the difference observed may be due entirely to the different experimental conditions in the two cases. Mme. Curie states that the activity of polonium decays slowly with the time, and mentions that one specimen lost half its activity in 11 months. The rate of decay of activity is about the same as that deduced from the product radium *E*. Mme. Curie, in addition, observed that an active product could be separated from radium itself by precipitating bismuth added to the radium solution. This active matter present with the bismuth could be con-

centrated in exactly the same way as was employed for the polonium obtained directly from a solution of pitchblende. Giesel long ago observed that bismuth was made active when placed in a radium solution and considered that polonium was in reality "induced bismuth." The product removed on the bismuth must in both cases have been radium *E*, so that we have here direct evidence that polonium and radium *E* exhibit similar chemical properties.

In the original paper giving an account of the discovery of polonium, Mme. Curie states that the active matter could be concentrated to some extent by heating the active sulphide in a vacuum. The active sulphide was more volatile than the bismuth and was deposited on portions of the glass tube between 300 deg. C. and 350 deg. C. On the other hand, I have shown that radium *E* deposited on a platinum plate is not appreciably volatile until a temperature of nearly 1000 deg. C. It is intended to examine this point still further in order to see if this difference of behavior is only apparent or real.

The experiments as a whole are, I think, best explained on the view that polonium and radio-tellurium both contain the same radioactive constituent which is the fifth disintegration product of radium. The most definite method of settling the matter is to compare the dates of decay of the activity of the three active substances, and experiments of this character are already in progress.

It would be of scientific value to isolate the product radium *D* from pitchblende, for, in many respects, it would be as useful scientifically as radium itself. Its activity in the pure state measured by the β rays would be about 25 times that of radium, and the rate of change of its activity is sufficiently slow to be negligible in most experiments.

Experiments are in progress to see if a simple method can be found for separation of radium *D* from pitchblende.⁸

8. Mr. B. Boltwood, of New Haven, Conn., very kindly forwarded me a few days ago a specimen of radioactive lead which he had separated from pitchblende four months before. This lead gave out an unusually large proportion of β compared with α rays, and the total amount of β rays from it was about the same as that given out by the uranium present in the pitchblende from which it was separated. In dissolving the lead some of the α -ray activity was removed on a bismuth plate. I think that it is probable that the lead contains the product radium *D*. These results suggest that Hoffmann, whose earlier work on radio-lead was the subject of much criticism, was probably right in believing that he had separated a new radioactive constituent with the lead, the activity of which did not decay with the time.

DISCUSSION.

DOCTOR BANGBOFF: Speaking rather as a chemist than as a physicist, I must express my joy at learning that these different things, radium, tellurium, radio-bismuth, polonium, etc., are all being brought together under one head. At one time we were confronted with the unfortunate prospect that all our known elements might appear in duplicate, one series being radio-active and the other the elements as we now know them. Mr. Rutherford has freed us from this nightmare, and the chemists are duly grateful. No doubt some one else will speak for the physicists.

DOCTOR THOMAS: I should like to ask whether there is any possibility of finding a process of hastening this decay of radium so that we need not wait for generations to study these forces.

PROFESSOR RUTHERFORD: Unfortunately, radium does not want to be hurried up. It prefers to lead a comparatively quiet life. There is one point I have omitted to add in this connection. Curie and Danne have shown that the product radium *C* which emits α , β and γ rays, breaks up about 20 per cent faster when exposed to a high temperature, but at a still higher temperature returns to the original rate. As to the other products, there is, so far, no evidence that their rate of change is either hastened or retarded by temperature.

CHAIRMAN WEBSTER: It is certainly of great advantage to have communications of this sort "hot off the bat," so to speak. We are very much indebted to Professor Rutherford for this very important communication.

There is only one more paper, of which the author is present. I regret very much that he is present, as it predicts a very great drop of interest from these we have been having. It is a paper of a mathematical nature which I hardly know what to do with. I recommend all those who have anything better to do to go out now. I will ask Professor Nichols to take the chair.

Professor Nichols, as chairman, requested Professor Webster to read his paper referred to.

LORENTZ'S THEORY OF ELECTRICITY.

BY PROF. A. G. WEBSTER, *Delegate and President of the American Physical Society.*

Without doubt the chief advances made in physics during the nineteenth century were in connection with the conservation of energy and the luminiferous ether. The nature of the ether for a long time presented difficulties, which were experienced in the theory of light, until the brilliant idea occurred to Maxwell of making the same ether transmit electric and magnetic actions, thus leading him eventually to regard light as an electromagnetic phenomenon. Maxwell's theory of light has now apparently gained the victory over all its rivals, and we may consider the nature of the action of the ether to be suitably established, and the laws of both optics and electricity to be thoroughly explained, in so far as relates to bodies at rest. When we come to the case of bodies in motion, however, the case is by no means as simple. Maxwell did not explicitly work out the adaptation of his theory to media in motion, but this was done by Hertz in what seemed at the time a very satisfactory manner. Unfortunately the theory as left by Hertz fails to explain a number of phenomena of such importance that it can no longer be regarded as satisfactory.

There can be no doubt that one of the most important questions now engaging the attention of physicists is that of the mutual relations of the ether and matter, and of the various aspects of this question one of the leading ones is the question whether the ether is carried along with matter in its motion, or whether the matter flows through the ether, which freely penetrates it. Since the death of Hertz this question has been treated by numerous writers, of whom unquestionably the most fruitful has been Prof. H. A. Lorentz of Leiden. Professor Lorentz has presented a theory that overcomes many of the difficulties found in the theory of Hertz, and also adapts itself with the greatest ease to the investigation of the properties of electrons, which have now become of such absorbing interest. I have, therefore, considered that in presenting a paper to this body I could not do better, especially since to my knowledge

no account of Lorentz's theory has appeared in English, than to give an account of the essentials of Lorentz's theory in as compact a form as possible. The mathematics of Lorentz's work is so complicated as to cause it to be rather difficult reading, which I hope I may somewhat facilitate by this exposition. I have obtained my information from Lorentz's papers, "La Théorie Electromagnétique de Maxwell et son application aux Corps Mouvants," *Archives Néerlandaises*, 1892, pp. 363-552, "Versuch einer Theorie der Electricischen und Optischen Erscheinungen in bewegten Koepern," Leiden, 1895, and to his article in the "Encyclopædie der Mathematischen Wissenschaften," Bd. V. 2, which has recently appeared, also to an article by Liénard, in vols. 14 and 16 of *l'Éclairage Électrique*. I shall make use, as does Lorentz, of the notation of vector analysis, but shall use heavy Roman letters, as recommended by Heaviside, instead of his German letters for vectors. The component of a vector in any direction is denoted by a suffix denoting the direction. The scalar product of two vectors is denoted by (), the vector product by []. We shall use the following definitions and formulæ:

Scalar product,

$$1). (\mathbf{AB}) \equiv A_x B_x + A_y B_y + A_z B_z = (\mathbf{BA})$$

Vector product,

$$2). [\mathbf{AB}] \equiv A_y B_z - A_z B_y, A_z B_x - A_x B_z, A_x B_y - B_y A_x, \dots [\mathbf{BA}].$$

$$3). (\mathbf{A}[\mathbf{BC}]) - (\mathbf{B}[\mathbf{CA}]) - (\mathbf{C}[\mathbf{AB}]) = \begin{vmatrix} A_x & A_y & A_z \\ B_x & B_y & B_z \\ C_x & C_y & C_z \end{vmatrix}$$

$$4). [\mathbf{A}[\mathbf{BC}]] - \mathbf{B}(\mathbf{CA}) - \mathbf{C}(\mathbf{AB}).$$

Gradient,

$$5). \nabla \varphi \equiv \text{grad } \varphi \equiv \frac{\delta \varphi}{\delta x}, \frac{\delta \varphi}{\delta y}, \frac{\delta \varphi}{\delta z},$$

Derivation of vector by scalar,

$$6). \frac{\delta \mathbf{A}}{\delta t} \equiv \frac{\delta A_x}{\delta t}, \frac{\delta A_y}{\delta t}, \frac{\delta A_z}{\delta t}.$$

Divergence,

$$7). \text{div } \mathbf{A} \equiv \frac{\delta A_x}{\delta x} + \frac{\delta A_y}{\delta y} + \frac{\delta A_z}{\delta z}.$$

Laplacian,

$$7a). \operatorname{div}\operatorname{grad} \varphi = \frac{\delta^2 \varphi}{\delta x^2} + \frac{\delta^2 \varphi}{\delta y^2} + \frac{\delta^2 \varphi}{\delta z^2} \equiv \Delta \varphi.$$

Curl,

$$8). \operatorname{curl} \mathbf{A} \equiv \frac{\delta A_x}{\delta y} - \frac{\delta A_y}{\delta z}, \frac{\delta A_x}{\delta z} - \frac{\delta A_z}{\delta x}, \frac{\delta A_y}{\delta x} - \frac{\delta A_z}{\delta y}.$$

Derivative in direction \mathbf{A} ,

$$9). (\mathbf{A} \nabla) \mathbf{B} \equiv A_x \frac{\delta \mathbf{B}}{\delta x} + A_y \frac{\delta \mathbf{B}}{\delta y} + A_z \frac{\delta \mathbf{B}}{\delta z} = |\mathbf{A}| \frac{\delta \mathbf{B}}{\delta s}.$$

$$10). \operatorname{div} [\mathbf{A}\mathbf{B}] = (\mathbf{B} \operatorname{curl} \mathbf{A}) - (\mathbf{A} \operatorname{curl} \mathbf{B}).$$

$$11). \operatorname{curl} [\mathbf{A}\mathbf{B}] = \mathbf{A} \operatorname{div} \mathbf{B} - \mathbf{B} \operatorname{div} \mathbf{A} - (\mathbf{A} \nabla) \mathbf{B} + (\mathbf{B} \nabla) \mathbf{A}.$$

$$12). \operatorname{curl}^2 \mathbf{A} \equiv \operatorname{curl} \{ \operatorname{curl} \mathbf{A} \} = \operatorname{grad} \operatorname{div} \mathbf{A} - \Delta \mathbf{A}.$$

In this notation the equations of Maxwell for the free ether are

$$A). \operatorname{curl} \mathbf{H} = \frac{1}{c} \frac{\delta \mathbf{D}}{\delta t} = \frac{1}{c} \dot{\mathbf{D}}.$$

$$B). \operatorname{curl} \mathbf{D} = -\frac{1}{c} \frac{\delta \mathbf{H}}{\delta t} = -\frac{1}{c} \dot{\mathbf{H}}.$$

where \mathbf{H} denotes the magnetic field, \mathbf{D} the electric displacement, such that

$$13). \operatorname{div} \mathbf{H} = 0.$$

$$14). \operatorname{div} \mathbf{D} = \rho,$$

ρ being the electric volume density. Electric quantities are measured in the electrostatic, magnetic in the magnetic units, and c is the ratio of the units. By taking the curl or time derivative of either of equations A) or B), making use of the other, and of 12), we obtain the equations of propagation,

$$15). \Delta \mathbf{D} - \frac{1}{c^2} \ddot{\mathbf{D}} = 0, \quad \Delta \mathbf{B} - \frac{1}{c^2} \ddot{\mathbf{B}} = 0$$

which shows wave propagation with velocity c .

The fundamental hypothesis of Hertz is that a medium in motion carries the ether with it, that is, the lines of force are carried by the medium. Consequently the time variations on the right in A), B) are due not only to the change of the field at a particular point with the time, but also to the changing field brought with the moving substance from elsewhere to the point in question. By considering the motion of a circuit moving with the matter, Hertz finds that the right-hand member of A) is to be replaced by

$$16). \frac{\delta \mathbf{D}}{\delta t} + \mathbf{w} \operatorname{div} \mathbf{D} + \operatorname{curl} [\mathbf{D}\mathbf{w}]$$

where \mathbf{w} is the velocity of the medium, and similarly in equation

B). Of these three parts of the total current causing the curl of the magnetic field, the first being the time rate of increase of the electric displacement at a fixed point is the displacement current of Maxwell. The existence of this is proved by the propagation of waves. The second term, $\mathbf{w} \operatorname{div} \mathbf{D} = \rho \mathbf{w}$, being equal to the product of the density of electricity multiplied by the velocity of the matter carrying it, is the convection-current, whose existence was made evident by the experiments of Rowland and his successors. The third term, which is manifested when a dielectric is moved through an electric field, causing a magnetic field $[\mathbf{D}\mathbf{w}]$ was shown to exist, at least qualitatively, by an experiment of Röntgen, in which a dielectric disc was rotated between the plates of a condenser. We shall, therefore, call the term curl $[\mathbf{D}\mathbf{w}]$ the Röntgen current, the three terms being then the Maxwell, Rowland, and Röntgen currents.

In the equation *B*) the term curl $[\mathbf{B}\mathbf{w}]$ causing an electric field $[\mathbf{w}\mathbf{B}]$ is the familiar electromotive force in a moving conductor, and has just been demonstrated to exist in a dielectric by an experiment of H. A. Wilson performed in the laboratory of J. J. Thomson. By it are also explained the phenomena of unipolar induction.

If a vector \mathbf{F} becomes discontinuous at a certain surface its curl becomes infinite in such a way that the limit of the product of the curl by the thickness ϵ of the layer of discontinuity is equal to the tangential discontinuity, that is if \mathbf{N} is the unit normal from the side 1 to the side 2,

$$\lim_{\epsilon=0} (\epsilon \operatorname{curl} \mathbf{F}) = [\mathbf{N}(\mathbf{F}_2 - \mathbf{F}_1)]$$

Consequently in the rotating disc putting $\mathbf{F} = [\mathbf{D}\mathbf{w}]$, the Röntgen current is confined to the plane surfaces, and is *opposite* to the motion of rotation. If the condenser rotates bodily, so that the plates carry their charges, the Rowland current and the Röntgen current are equal and opposite, and we should expect no magnetic effect. This is contrary to the experiments of Eichenwald, who observed such a magnetic effect. These experiments are not, therefore, explained by Hertz's theory. Inasmuch as the primary supposition is that the field is carried by the moving substance, waves are carried with the velocity of the medium, and the phenomenon of aberration, together with the partial carrying of the waves with the coefficient of Fresnel, as evidenced by the experiments of Fizeau and Michelson, are not explained.

The production of the mechanical forces due to electric and mag-

netic actions was explained by Maxwell by means of stresses in the ether, and the values of these stresses were successfully calculated in the case of static fields, that is, those independent of the time. In the case of varying fields, however, it was shown by Helmholtz in his last paper that the resultant of the Maxwell stresses on a finite portion of the ether would not vanish, but would tend to set the ether in motion. This was felt to be a serious defect in the theory of Maxwell from which the theory of Lorentz is entirely free. The fundamental idea of Lorentz's theory is that all electrification is composed of charges carried by small bodies, or electrons, which are indestructible, and that all matter is constructed of aggregations of electrons, which move freely through the ether, without disturbing it in the slightest. Thus the only mechanical forces are the actions of the ether on the electrons, and where there are no electrons, as in the free ether, there is no force. Polarization of dielectrics is due to displacement of the electrons from their normal positions, as in the old theory of Poisson and Mossotti; conduction currents are due to the streaming motion of the electrons in the conductor; during electric waves in a dielectric the electrons vibrate, and magnetism is due to motion of rotation of electrons in the manner of Ampère's elementary currents. Thus Lorentz goes back in a measure to pre-Maxwellian ideas, but the importance of the ether is not diminished in the slightest, contrary to sometimes expressed opinions. On the contrary, the ether is still the seat of the energy, and transmits the actions between the electrons.

We will immediately write down the equations for moving bodies, all our vectors still denoting the state of the ether. Since the electrification is not destroyed we have, if \mathbf{v} denotes the velocity of the medium, the equation of continuity as in hydrodynamics,

$$17). \quad \frac{\delta \rho}{\delta t} + \text{div} (\rho \mathbf{v}) = 0.$$

The total current is considered to be the displacement current, representing the effect of the ether, $\dot{\mathbf{D}}$, and the convection current, $\rho \mathbf{v}$, representing the effect of the matter. Instead of equation A) we have, therefore,

$$A') \quad \text{curl } \mathbf{H} = \frac{1}{c} \{ \dot{\mathbf{D}} + \rho \mathbf{v} \}$$

while the equation B) remains the same.

$$B') \quad \text{curl } \mathbf{D} = -\frac{1}{c} \dot{\mathbf{H}}$$

It is to be noticed that the Röntgen current is absent, that being due to Hertz's hypothesis of the dragging of the ether.

For the force on an electron we have two parts. Referring to unit volume we have first the ordinary electric force, $\rho \mathbf{D}$, while secondly we have the force due to the motion in the magnetic field. Since a conductor carrying a current is urged across the field it is natural to suppose that the moving electrons composing it are likewise. Consequently Lorentz assumes a second term in the force having the value, $\frac{\rho}{c} [\mathbf{v}\mathbf{H}]$, so that for unit of electricity per unit volume

$$18). \quad \mathbf{F} = \mathbf{D} + \frac{1}{c} [\mathbf{v}\mathbf{H}].$$

In order to obtain the equations of propagation we proceed as before, differentiating equation A' by the time, and substituting for curl $\dot{\mathbf{H}}$ its value derived from taking the curl of equation B' .

$$19). \quad \text{curl } \dot{\mathbf{H}} = \frac{1}{c} \left\{ \ddot{\mathbf{D}} + \frac{\delta}{\delta t} (\rho \mathbf{v}) \right\} - c \text{curl}^2 \mathbf{D} - c \left\{ \Delta \mathbf{D} - \text{grad div } \mathbf{D} \right\}.$$

Thus we obtain,

$$20). \quad \Delta \mathbf{D} = \frac{1}{c^2} \ddot{\mathbf{D}} = \text{grad } \rho + \frac{1}{c^2} \frac{\delta}{\delta t} (\rho \mathbf{v}).$$

Proceeding in the converse manner, and with $\text{div } \mathbf{H} = 0$,

$$21). \quad \text{curl } \dot{\mathbf{D}} = -\frac{1}{c} \ddot{\mathbf{H}} = c \text{curl}^2 \mathbf{H} - \text{curl} (\rho \mathbf{v}) = -c \Delta \mathbf{H} - \text{curl } \rho \mathbf{v}.$$

giving the other equation,

$$22). \quad \Delta \mathbf{H} = \frac{1}{c^2} \ddot{\mathbf{H}} = -\frac{1}{c} \text{curl} (\rho \mathbf{v}).$$

The equations of Maxwell have here been shown without the introduction of the scalar or vecto-potentials. Since $\text{div } \mathbf{H} = 0$ we may put

$$23). \quad \mathbf{H} = \text{curl } \mathbf{A},$$

which is the definition of the vector potential, and when we have the static case, the time derivatives vanishing, B) gives

$$24). \quad \text{curl } \mathbf{D} = 0,$$

which is the condition that \mathbf{D} has a scalar potential,

$$25). \quad \mathbf{D} = -\text{grad } \varphi.$$

Since this equation does not hold when the fields vary, Hertz and Heaviside preferred not to introduce the potentials, but to deal directly with the fields, as we have done. Recently, however, it has been shown by Liénard and Wiechert that we may still conveniently use both potentials. Introducing 23) into A' and B' ,

$$26). \quad \frac{1}{c} \{ \dot{\mathbf{D}} + \rho \mathbf{v} \} = \text{curl}^2 \mathbf{A} = \text{grad div } \mathbf{A} - \Delta \mathbf{A},$$

$$27). \quad \text{curl } \mathbf{D} = -\frac{1}{c} \text{curl } \dot{\mathbf{A}},$$

and since from the latter,

$$28). \quad \text{curl} \left\{ \mathbf{D} + \frac{1}{c} \dot{\mathbf{A}} \right\} = 0,$$

$$29). \quad \mathbf{D} + \frac{1}{c} \dot{\mathbf{A}} = -\text{grad } \varphi.$$

Differentiating by the time,

$$30). \quad \dot{\mathbf{D}} = -\frac{1}{c} \ddot{\mathbf{A}} = \text{grad } \dot{\varphi}.$$

Introducing this into 26),

$$31). \quad -\frac{1}{c} \left\{ \frac{1}{c} \ddot{\mathbf{A}} + \text{grad } \dot{\varphi} - \rho \mathbf{v} \right\} = \text{grad div } \mathbf{A} - \Delta \mathbf{A}.$$

Taking divergence of 29)

$$32). \quad \rho + \frac{1}{c} \text{div } \dot{\mathbf{A}} = -\Delta \varphi.$$

Now a vector is determined by its divergence and curl conjointly. We have only the curl of \mathbf{A} already given by 23); accordingly let us put,

$$33). \quad \text{div } \mathbf{A} = -\frac{1}{c} \dot{\varphi}$$

which reduces 32) and 31) to

$$34). \quad \Delta \varphi - \frac{1}{c^2} \ddot{\varphi} = -\rho$$

$$35). \quad \Delta \mathbf{A} - \frac{1}{c^2} \ddot{\mathbf{A}} = -\frac{1}{c} \rho \mathbf{v}.$$

Accordingly the potentials φ, \mathbf{A} are propagated according to the same laws as \mathbf{D}, \mathbf{H} , which may be found from them by the equations

$$29). \quad \mathbf{D} = -\text{grad } \varphi - \frac{1}{c} \dot{\mathbf{A}},$$

23). $\mathbf{H} = \text{curl } \mathbf{A}$,

which were in fact given by Maxwell. From these equations and 34), 35), may in fact be deduced 20) and 22), as follows:

$$\begin{aligned} \ddot{\mathbf{H}} &= \text{curl } \ddot{\mathbf{A}} = c^2 \left\{ \text{curl } \Delta \mathbf{A} + \frac{1}{c} \text{curl } (\rho \mathbf{v}) \right\} \\ &= c^2 \Delta \mathbf{H} + c \text{curl } (\rho \mathbf{v}), \\ \Delta \mathbf{D} &= - \text{grad } \Delta \varphi - \frac{1}{c} \Delta \dot{\mathbf{A}} \end{aligned}$$

and by 32)

$$\Delta \mathbf{D} = \text{grad } \rho + \frac{1}{c} \text{grad div } \dot{\mathbf{A}} - \frac{1}{c} \Delta \dot{\mathbf{A}}$$

so that by 26)

$$\Delta \mathbf{D} = \frac{1}{c} \left\{ \ddot{\mathbf{D}} + \frac{\delta}{\delta t} (\rho \mathbf{v}) \right\} + \text{grad } \rho.$$

The equation

36). $\Delta \psi - \frac{1}{c^2} \ddot{\psi} = \ddot{\omega}$

was thoroughly investigated by Lorentz in his paper of 1892, and also by Beltrami a few months earlier (Sull'espressione analitica del principio di Huygens. *Atti dei Lincei*, Ser. V, Vol. I, 6 Marzo, 1892). The result is that at a point x, y, z , from which the distance to the point of integration is r and within a closed surface S ,

$$\begin{aligned} 37). \quad \psi &= - \frac{1}{4\pi} \iiint \frac{1}{r} \{ \omega \} d\tau \\ &+ \frac{1}{4\pi} \iint \left[\frac{1}{r} \left\{ \frac{\delta \psi}{\delta n} \right\} - \left\{ \psi \right\} \frac{\delta}{\delta n} \frac{1}{r} + \frac{1}{c} \left\{ \dot{\psi} \right\} \frac{1}{r} \frac{\delta r}{\delta n} \right] dS \end{aligned}$$

where the brackets $\{ \}$ denote that the value of the quantity is taken not for the time t in question, but for the various times $t - r/c$. If the surface is removed to infinity the surface integrals vanish. Accordingly we have for the potentials,

38). $\varphi = \frac{1}{4\pi} \iiint \frac{\{ \rho \}}{r} d\tau,$

39). $\mathbf{A} = \frac{1}{4\pi c} \iiint \frac{\{ \rho \mathbf{v} \}}{r} d\tau.$

These solutions show that both the scalar and vector potentials are propagated from electrons, and from moving electrons respectively, with the velocity c . Accordingly the quantities φ, \mathbf{A} are called the *retarded* potentials. The foregoing equations constitute the main basis of Lorentz's theory.

Let us now consider the work done by the electric forces acting on the charged matter. The rate of doing work is

$$40). P = \iiint (\mathbf{F}\mathbf{v}) \rho d\tau = \iiint (\mathbf{D}\cdot\rho\mathbf{v}) d\tau, \text{ (since } (\mathbf{v}[\mathbf{v}\mathbf{H}]) = 0 \text{) and replacing } \rho\mathbf{v} \text{ by its value from } A'),$$

$$41). P = \iiint (\mathbf{D}\{c \text{ curl } \mathbf{H} - \dot{\mathbf{D}}\}) d\tau.$$

Replacing $\mathbf{D} \text{ curl } \mathbf{H}$ by its value by 10), and using the divergence theorem,

$$42). P = \iiint \{c(\mathbf{H} \text{ curl } \mathbf{D} + \text{div } [\mathbf{H}\mathbf{D}]) - (\mathbf{D}\dot{\mathbf{D}})\} d\tau. \\ = -c \iint [\mathbf{D}\mathbf{H}]_n dS - \iiint (\mathbf{D}\dot{\mathbf{D}} + \mathbf{H}\dot{\mathbf{H}}) d\tau.$$

This is Poynting's theorem, and says that if

$$43). \mathbf{S} = c [\mathbf{D}\mathbf{H}]$$

is the amount of energy proceeding through unit of surface per unit of time, and the energy of the field is

$$44). \mathbf{W} = \frac{1}{2} \iiint (\mathbf{D}^2 + \mathbf{H}^2) d\tau.$$

then

$$45). - \iint \mathbf{S}_n dS = P + \frac{d\mathbf{W}}{d\tau}$$

expresses the fact that the energy flowing *into* any surface goes to doing work on the electrified matter within and storing of energy in the ether.

The mechanical force on any portion of matter is

$$46). \iiint \mathbf{F} d\tau = \iiint \left\{ \rho \mathbf{D} + \frac{1}{c} [\rho \mathbf{v} \cdot \mathbf{H}] \right\} d\tau \\ = \iiint \left\{ \mathbf{D} \text{ div } \mathbf{D} + \frac{1}{c} [(c \text{ curl } \mathbf{H} - \dot{\mathbf{D}}) \mathbf{H}] \right\} d\tau.$$

Of this the X-component is

$$47). \Xi = \iiint \left\{ \mathbf{D}_x \text{ div } \mathbf{D} + [\text{curl } \mathbf{H} \cdot \mathbf{H}]_x - \frac{1}{c} [\dot{\mathbf{D}}\mathbf{H}] \right\} d\tau.$$

and integrating the first term by parts,

$$48). \Xi = \iint \mathbf{D}_x \mathbf{D}_n dS - \iiint \left\{ \mathbf{D}_x \frac{\delta \mathbf{D}_x}{\delta x} + \mathbf{D}_y \frac{\delta \mathbf{D}_x}{\delta y} \right. \\ \left. + \mathbf{D}_z \frac{\delta \mathbf{D}_x}{\delta z} \right\} d\tau + \iiint \left\{ \left(\frac{\delta \mathbf{H}_x}{\delta z} - \frac{\delta \mathbf{H}_y}{\delta x} \right) \mathbf{H}_z \right.$$

$$- \left(\frac{\delta H_y}{\delta x} - \frac{\delta H_x}{\delta y} \right) H_y - \frac{1}{c} [\dot{D}H]_x \} d\tau.$$

Replacing $\frac{\delta D_x}{\delta y}$ and $\frac{\delta D_x}{\delta z}$ by their values from

$$- \left(\frac{\delta D_y}{\delta x} - \frac{\delta D_x}{\delta y} \right) = \frac{1}{c} \dot{H}_x \frac{\delta D_x}{\delta z} - \frac{\delta D_x}{\delta x} = - \frac{1}{c} \dot{H}_y,$$

we obtain

$$\begin{aligned} 49). \quad \mathfrak{E} = & \int \int D_x D_n dS \int \int \int \left\{ D_x \frac{\delta D_x}{\delta x} + D_y \left(\frac{1}{c} \dot{H}_x \right. \right. \\ & + \left. \left. \frac{\delta D_y}{\delta n} \right) + D_x \left(\frac{\delta D_x}{\delta x} - \frac{1}{c} \dot{H}_y \right) + \frac{1}{c} (\dot{D}_y H_x - \dot{D}_x H_y) \right. \\ & + H_x \frac{\delta H_x}{\delta x} + H_y \frac{\delta H_y}{\delta y} + H_x \frac{\delta H_x}{\delta z} + H_x \operatorname{div} H \} d\tau \\ & + \int \int H_x H_n dS \\ & = \int \int (D_x D_n + H_x H_n) dS - \frac{1}{2} \frac{\delta}{\delta x} \{ H^2 + D^2 \} d\tau - \\ & \quad \frac{1}{c} \frac{d}{d\tau} \int \int \int (D_y H_x - D_x H_y) d\tau. \end{aligned}$$

The first two terms give the stresses given by Maxwell, but there remains the last term which is the X-component of the force

$$50) \quad \mathfrak{F} = - \frac{1}{c} \frac{d}{dt} \int \int \int [DH] d\tau = - \frac{1}{c^2} \int \int \int \frac{d\mathbf{S}}{dt} d\tau.$$

If the ether is free from electrons, the force vanishes, that is the force due to the ether-stresses is just counterbalanced by the force \mathfrak{F} . We accordingly see how, as has been stated, the Maxwell-Hertz theory, representing the force only by the stresses, leaves a resultant force on the free ether, as soon as the Poynting radiant vector \mathbf{S} varies with the time.

If now we remove the bounding surfaces to infinity, we have for the force on the electrified matter only the force 50). This represents the rate of change of momentum of the matter, so that if we call

$$51). \quad \mathbf{M} = \frac{1}{c^2} \int \int \int \mathbf{S} d\tau$$

the *electromagnetic momentum* of the space in question, we find that the momentum of the matter together with \mathbf{M} is subject to conservation. We may accordingly express the result in the words

of Poincaré (La Théorie de Lorentz et le Principe de Réaction, Lorentz, Livre Jubilaire, p. 256), "We may regard the electromagnetic energy as a fictitious fluid of density $\frac{\mathbf{S}}{c^2}$, which moves in space according to the laws of Poynting. Only we must admit that the fluid is not indestructible and that in the unit of time the quantity $\iiint (\mathbf{B} \cdot \rho \mathbf{v}) d\tau$ is destroyed (or created if this expression is negative)." Then the momentum of this fluid is represented for each unit of volume by the expression \mathbf{S}/c^2 , and wherever the energy stream is increasing, it pushes back on the matter. As, however, the matter does not push back against the ether, the principle of equality of action and reaction is violated. This is, however, not an objection, as the ether is supposed immovable, so that to speak of forces on it is unnecessary. In fact as soon as forces are propagated with a finite velocity we cannot expect the forces acting between two bodies to be equal and opposite at the same time, as long as we have a variable state.

We come now to the equations for bodies in motion. Lorentz considers only a body moving with a constant translation \mathbf{p} , to which the axes of co-ordinates are rigidly attached. If we call the co-ordinates with respect to the moving axes x', y', z' , we have

$$52). \quad \begin{aligned} x &= x' + \mathbf{p}_x t, \\ y &= y' + \mathbf{p}_y t, \\ z &= z' + \mathbf{p}_z t, \end{aligned}$$

so that evidently

$$\frac{\delta}{\delta x} = \frac{\delta}{\delta x'}, \quad \frac{\delta}{\delta y} = \frac{\delta}{\delta y'}, \quad \frac{\delta}{\delta z} = \frac{\delta}{\delta z'}$$

Also if the sign d denotes differentiation as we follow a particular material point, we have (as in fluid motion)

$$\frac{d}{dt} = \frac{\delta}{\delta t} + \mathbf{p}_x \frac{\delta}{\delta x} + \mathbf{p}_y \frac{\delta}{\delta y} + \mathbf{p}_z \frac{\delta}{\delta z}$$

so that we may now leave off distinguishing marks from the co-ordinates and use the symbol δ instead of d . Thus the only changes in our equations are to be the substitution of $\frac{d}{dt} - (\mathbf{p} \nabla)$ for the derivative in t . Using equation 11), since, on account of the constancy of \mathbf{p}

$\text{div } \mathbf{p} = 0$, and since $\text{div } \mathbf{H} = 0$, equation B' becomes

$$53). \quad -\text{curl } \mathbf{D} - \frac{1}{c} \left\{ \frac{\delta \mathbf{H}}{\delta t} - (\mathbf{p} \nabla) \mathbf{H} \right\} - \frac{1}{c} \left\{ \frac{\delta \mathbf{H}}{\delta t} + \text{curl } [\mathbf{pH}] \right\}$$

$$54). \quad \text{curl} \left\{ \mathbf{D} + \frac{1}{c} [\mathbf{pH}] \right\} = -\frac{1}{c} \dot{\mathbf{H}}.$$

If we now use the letter \mathbf{v} for the relative velocity, A') becomes

$$55). \quad \text{curl } \mathbf{H} - \frac{1}{c} \left\{ \frac{\delta \mathbf{D}}{\delta t} - (\mathbf{p} \nabla) \mathbf{D} + \rho (\mathbf{p} + \mathbf{v}) \right\} = \frac{1}{c} \left\{ \frac{\delta \mathbf{D}}{\delta t} + \text{curl } [\mathbf{pD}] - \mathbf{p} \text{ div } \mathbf{D} + \rho (\mathbf{p} + \mathbf{v}) \right\}$$

$$56). \quad \text{curl} \left\{ \mathbf{H} - \frac{1}{c} [\mathbf{pD}] \right\} = \frac{1}{c} \left\{ \dot{\mathbf{D}} + \rho \mathbf{v} \right\}.$$

Introducing the new vectors

$$57). \quad \mathbf{D}' = \mathbf{D} + \frac{1}{c} [\mathbf{pH}],$$

$$58). \quad \mathbf{H}' = \mathbf{H} - \frac{1}{c} [\mathbf{pD}],$$

we thus obtain

$$59). \quad \text{curl } \mathbf{D}' = -\frac{1}{c} \dot{\mathbf{H}}$$

$$60). \quad \text{curl } \mathbf{H}' = \frac{1}{c} \left\{ \dot{\mathbf{D}} + \rho \mathbf{v} \right\}$$

which contain on the left the same functions of the vectors \mathbf{D}' , \mathbf{H}' , that the equations A) B) for fixed axes did of \mathbf{D} , \mathbf{H} . On the right we have, however, the old vectors \mathbf{D} , \mathbf{H} , but the *relative* velocity, \mathbf{v} . In order to free the equations 59), 60) from the vectors \mathbf{D} , \mathbf{H} , Lorentz introduces a new variable t' called the local time, defined as

$$61). \quad t' = t - \frac{1}{c^2} (\mathbf{p}_x x + \mathbf{p}_y y + \mathbf{p}_z z).$$

Thus all planes perpendicular to the direction of motion have the same local time, and the difference in local time between two such planes is the fraction p/c of the time that it would take a disturbance to travel from one plane to the other. The quantity p/c will be considered so small that its square may be neglected. Thus in the quantities,

$$62). \quad \frac{1}{c} [\mathbf{pD}'] = \frac{1}{c} [\mathbf{pD}] + \frac{1}{c^2} [\mathbf{p}[\mathbf{pH}]],$$

$$63). \quad \frac{1}{c} [\mathbf{pH}'] = \frac{1}{c} [\mathbf{pH}] - \frac{1}{c^2} [\mathbf{p}[\mathbf{pD}]],$$

in the last term we have negligible quantities, so that it is immaterial whether we write $[pD]$ or $[pD']$, $[pH]$ or $[pH']$. In changing the variables from x, y, z, t to x, y, z, t' , we evidently have

$$64). \quad \frac{\delta}{\delta t} = \frac{\delta}{\delta t'}, \quad \frac{\delta}{\delta x} = \left(\frac{\delta}{\delta x}\right)' - \frac{p_x}{c^2} \frac{\delta}{\delta t'}, \text{ etc.,}$$

where the accent denotes differentiation under the latter circumstances. Accordingly for any vector \mathbf{F} (\mathbf{p} being constant, passing under the differentiations)

$$65). \quad \text{curl } \mathbf{F} = \text{curl}' \mathbf{F} - \frac{1}{c^2} \frac{\delta}{\delta t'} [p\mathbf{F}].$$

Applying this to $D', H', 59)$ and $60)$ become

$$66). \quad \text{curl } D' - \frac{1}{c^2} \frac{\delta}{\delta t'} [pD'] = -\frac{1}{c} \frac{\delta H}{\delta t'},$$

$$67). \quad \text{curl } H' - \frac{1}{c^2} \frac{\delta}{\delta t'} [pH'] = \frac{1}{c} \left\{ \frac{\delta D}{\delta t'} + \rho \mathbf{v} \right\},$$

and dropping the accents in the vector products, as above, we have finally

$$B') \quad \text{curl } D' = -\frac{1}{c} \frac{\delta H'}{\delta t'}$$

$$A') \quad \text{curl } H' = \frac{1}{c} \left\{ \frac{\delta D'}{\delta t'} + \rho \mathbf{v} \right\}$$

Thus the new vectors D', H' satisfy in terms of the local time, and the relative co-ordinates x, y, z , with respect to the moving axes, equations of precisely the same form as the equations $A), B)$, which are satisfied in terms of the absolute time and the absolute co-ordinates x, y, z , by the field vectors, D, H , in a system at rest. From this result we have Lorentz's Principle of Corresponding States: If in a system of bodies at rest we know a possible state in which $D_x, D_y, D_z, H_x, H_y, H_z$, are certain functions of x, y, z, t , then in the same system moving with a velocity \mathbf{p} another state is possible in which $D_x', D_y', D_z', H_x', H_y', H_z'$, are the same functions of x, y, z, t' . As an example let us consider wave motion in which the various quantities are periodic functions of

$$t - \frac{b_x x + b_y y + b_z z}{W}$$

where b_x, b_y, b_z , are the direction cosines of the wave-plane in a fixed system. In the corresponding state in the moving system we have the same functions of

$$t' - \frac{b_x x + b_y y + b_z z}{W} = t - \left(\frac{p_x}{c^2} + \frac{b_x}{W}\right) x - \left(\frac{p_y}{c^2} + \frac{b_y}{W}\right) y - \left(\frac{p_z}{c^2} + \frac{b_z}{W}\right) z$$

Replacing the relative co-ordinates x, y, z , by their values in terms of absolute co-ordinates x, y, z , by the equations

$$\begin{aligned} x &= X - \mathbf{p}_x t \\ y &= Y - \mathbf{p}_y t \\ z &= Z - \mathbf{p}_z t \end{aligned}$$

we find a change of period, giving us Doppler's principle. Furthermore, without passing to absolute co-ordinates, we find for the direction cosines of the wave-normal in the moving system,

$$b_x' : b_y' : b_z' = \left(b_x + \frac{W \mathbf{p}_x}{c^2} \right) : \left(b_y + \frac{W \mathbf{p}_y}{c^2} \right) : \left(b_z + \frac{W \mathbf{p}_z}{c^2} \right)$$

and if the propagation is in the pure ether, so that $W = c$,

$$b_x' : b_y' : b_z' = \left(b_x + \frac{\mathbf{p}_x}{c} \right) : \left(b_y + \frac{\mathbf{p}_y}{c} \right) : \left(b_z + \frac{\mathbf{p}_z}{c} \right),$$

from which may be derived

$$b_x : b_y : b_z = \left(b_x' - \frac{\mathbf{p}_x}{c} \right) : \left(b_y' - \frac{\mathbf{p}_y}{c} \right) : \left(b_z' - \frac{\mathbf{p}_z}{c} \right).$$

Thus we have the explanation of aberration, in that the light apparently comes in a direction obtained by compounding the reversed velocity of the earth with that of the light.

Finally if we put in the case of ponderable matter

$$\frac{b_x}{W} + \frac{\mathbf{p}_x}{c^2} = \frac{b_x'}{W'}, \quad \frac{b_y}{W} + \frac{\mathbf{p}_y}{c^2} = \frac{b_y'}{W'}, \quad \frac{b_z}{W} + \frac{\mathbf{p}_z}{c^2} = \frac{b_z'}{W'}$$

W' is the velocity of the waves in the body, and we find

$$\frac{1}{W'^2} = \frac{1}{W^2} + 2 \frac{b_x \mathbf{p}_x + b_y \mathbf{p}_y + b_z \mathbf{p}_z}{W c^2} = \frac{1}{W^2} + 2 \frac{\mathbf{p}_n}{W c^2}$$

or
$$W' = W - \mathbf{p}_n \left(\frac{W}{c} \right)^2.$$

Replacing c/w by μ , the index of refraction of the body, we find

$$W' = W - \frac{\mathbf{p}_n}{\mu^2}$$

which gives us Fresnel's coefficient of entrainment of the waves. Now since W' is the velocity relative to the moving medium, the absolute velocity is found by adding to this \mathbf{p}_n , the velocity of the medium in the direction of the wave-normal. We thus obtain

$$W' = W + \left(1 - \frac{1}{\mu^2} \right) \mathbf{p}_n,$$

giving us Fresnel's assumed coefficient of entrainment.

I have thus given a summary exposition of the principal points in Lorentz's theory, and shown how it succeeds where Hertz's does not. It should be added in conclusion, that in dielectrics, the electric displacement \mathbf{D} is considered to be the resultant of two parts, \mathbf{d} the displacement in the ether, and \mathbf{P} , the polarization due to the displacement of the electrons, as in the Poisson-Mossotti theory. When the dielectric is moved it is only the latter part that gives rise to a current, so that instead of obtaining equation 16) according to Hertz, we obtain a similar one in which the Röntgen current appears as $\text{curl} [\mathbf{P}\mathbf{w}]$ instead of $\text{curl} [\mathbf{D}\mathbf{w}]$. Thus the Röntgen current and the Rowland current do not compensate each other in the rotating condenser, and the experimental results of Eichenwald are found to agree with the theory.

There being no further discussion, the following papers were read by title, and the Section finally adjourned.

ELECTRIC CONDUCTION IN METALS, FROM THE STANDPOINT OF THE ELECTRONIC THEORY.

BY PROF. P. DRUDE, *Giessen University.*

The suggestion that electric conduction in metals is essentially the same as in electrolytes, that is to say, that it is effected by the movement of small charged particles, was first made by W. Weber,¹ who made use of it to derive Ohm's law. It has since been taken up by J. J. Thomson² and developed by Giese,³ Riecke⁴ and Drude.⁵ The theory as extended by the two latter explains all the known electrical and thermal properties of metals (including the effects observed in a magnetic field) and as given by Drude⁶ attempts to explain their optical behavior. J. J. Thomson⁷ employed the theory to explain electric conduction in metals and used it to calculate their increase of resistance in a magnetic field. Drude's⁸ form of the theory, which differs from Riecke's more general one in making certain assumptions⁹ tending to simplify it, renders possible experimental verification and the ratio of the thermal and electrical conductivities of the metals as calculated by it agrees with experiment. H. A. Lorentz¹⁰ has recently treated the subject both generally and from Drude's standpoint. From the theory he makes various deductions capable of numerical verification and derives the experimental law of radiation from a black body. The treatment that follows may be found to contain some hitherto unpublished ideas and calculations.

1. W. Weber. "Gesammelte Werke," 4, p. 91, 1862; p. 247, 1871; p. 312, 1875; p. 479.

2. J. J. Thomson. "Applications of Dynamical Principles to Physics and Chemistry."

3. W. Giese. *Wied. Ann.* 37, p. 576, 1889.

4. E. Riecke. *Wied. Ann.* 66, pp. 353, 545, 1898.

5. P. Drude. *Ann. der Physik*, 1, p. 566; 3, p. 369, 1900.

6. P. Drude. *Physik. Zeit.*, 1, p. 161, 1900, and "Lehrbuch der Optik," Leipzig, 1900.

7. J. J. Thomson. *Rapp. du Congr. Internat. de Physique à Paris*, 1900, III, p. 138.

8. Drude's calculation has been improved upon by M. Reinganum *Ann. der Physik*, 2, p. 398, 1900.

9. Cf. E. Riecke. *Ann. der Physik*, 2, p. 835, 1900.

10. H. A. Lorentz. *Versl. K. Akad. van Wet.*, 1902-3, p. 787.

The theories of Riecke, Drude and J. J. Thomson are based on the assumption that among the atoms of a metal very small charged particles (electrons) move to and fro like the molecules of a gas on the kinetic theory. Riecke and Drude assume that there are several kinds of electrons—positively and negatively charged; Thomson postulates only one kind—the negatively charged electrons. The electric and thermal properties of metals in a magnetic field, explained by Riecke and Drude on the assumption that there are two kind of electrons, seem to be equally well accounted for by assuming only one kind.¹¹ This latter form of the theory, due to J. J. Thomson, is preferable not only on account of its simplicity, but because it explains the fact that no transfer of matter has ever been observed to accompany the electric current in metals. On this hypothesis the carriers of electricity are identical with the negatively charged particles of the kathode rays for which the ratio of the charge e to the mass m , as deduced from the deviation of the rays in a magnetic field, is a universal constant (1.86×10^{-7} accounting to the experiments of Kaufmann, Simon and Seitz,¹² e being expressed in electromagnetic units). We need not postulate actual mass for these electrons, as they will, on account of self-induction and in virtue of the movement of the small charge e , possess a quasi-inertia.¹³ This supposition receives support from the experiments of Kaufmann,¹⁴ who showed that in the case of the Becquerel rays, e/m decreases as the velocity increases. M. Abraham¹⁵ has shown that Kaufmann's results can be explained on the assumption that m is of purely electromagnetic origin. We might also assume the existence of positively charged electrons whose mass was only apparent.¹⁶ However it is only in the case of the negative electrons that a constant ratio e/m is observed. In the case of the carriers of positive electricity (canal rays) e/m is considerably smaller and is variable. The positive electricity thus

11. We shall not discuss this question here, as the phenomena observed in a magnetic field lie outside the scope of this paper.

12. For the literature on this point see W. Seitz, *Ann. der Physik*, 8, p. 233, 1902.

13. Cf. W. Sutherland. *Phil. Mag.* 47, p. 269, 1899, and P. Drude, *Ann. der Physik*, 1, p. 609, 1900.

14. W. Kaufmann, *Verhandl. der 74 Naturfor. Vers. in Karlsbad*, 1903; *Physik. Zeit.*, 4, p. 54, 1902.

15. M. Abraham. *Ann. der Physik*, 10, p. 105, 1903.

16. This assumption I made in the paper quoted above. *Ann. der Physik*, 1, p. 566, 1900.

appears to be bound to matter. In what follows the term electron will be restricted to the negatively charged particles for which the ratio e/m has a definite value. Electrical conduction is explained by assuming that in every cubic cm of the metal there are present a certain number N of freely moving electrons, bound to no position of equilibrium, that is, neither to the atom nor to the molecule. Of course it is possible that bound electrons may exist in addition to the free. In a non-conductor only bound electrons are present. It is these that determine the dielectric constant of the substance, its index of refraction and its optical dispersion. All the metals are good conductors, that is to say, they contain free as well as bound electrons. This is in agreement with the fact that in electrolysis the metals appear only as kations. On the unitary theory of electricity, a substance appears as a kation when one or more electrons are taken from it by another substance. In substances that readily appear as kations the connection between kation and atom must be a comparatively loose one to permit the liberation (dissociation) of a certain number of bound electrons.

Derivation of Ohm's law.—Suppose an electric field X , in absolute electromagnetic units, to act on an electron of (apparent) mass m and charge e . For the time τ between two collisions the following equation holds:

$$m \frac{d^2 \xi}{dt^2} = e X, \quad (1)$$

where ξ represents the component, in the direction of X , of the path traversed by the electron between two collisions. Integrating (1), we have

$$m \xi = \frac{1}{2} e X \tau^2 + a \tau + b.$$

When subjected to the field X for a sufficient time, the electrons possess, in addition to their original undetermined velocities, a constant mean velocity u in the direction of X ,

$$u_x = \frac{1}{2} e X \frac{\tau}{m}. \quad (2)$$

The time τ between two collisions and the length of the free path of the electrons are connected by the equation

$$u \tau = l. \quad (3)$$

If there be present in each cubic cm of the conductor, N free electrons, each of which has a component velocity u_x in the

direction of X , then the quantity of electricity carried across unit area in unit time is the current density

$$I_x = e N u_x = \frac{1}{2} e^2 N \frac{\tau}{m} X. \quad (4)$$

Comparing this equation with Ohm's law, we have

$$\sigma = \frac{1}{2} e^2 N \frac{\tau}{m} = \frac{1}{2} e^2 N \frac{l}{u m} \quad (5)$$

where σ denotes the conductivity in absolute electromagnetic units. In equation (5), u , τ and l must be taken as mean values.¹⁷

Joule's law for the heat produced by the passage of a current is derived from the consideration, that the increased kinetic energy of the electrons produced by the expenditure of the electrical energy $e X l$ in the time τ , is dissipated by collisions between the electrons themselves and the atoms of the metal, but increases the mean kinetic energy of irregular motion of the electrons and of the atoms, thus appearing as equivalent heat energy.

Connection Between the Kinetic Energy of the Electrons and the Absolute Temperature on Drude's Theory.

In the kinetic theory of gases there is a theorem by Boltzmann¹⁸ that, when a state of thermal equilibrium is reached, the mean kinetic energy of all the molecules is the same. This theorem enables us to fix a scale of absolute temperatures by making T , the absolute temperature, proportional to the mean kinetic energy of the molecules. Drude has applied these considerations to the motion of electrons, putting the mean value of their kinetic energy

$$\frac{1}{2} m u^2 = x T \quad (6)$$

where x is a *universal* constant; that is to say, it has the same value as in the kinetic gas theory, where $\frac{1}{2} m u^2$ is referred to the molecule. That this must be so appears from the consideration that when a state of thermal equilibrium is reached, the mean

17. An accurate determination of the factors of σ is for this reason laborious, and leads to different results according as l is supposed constant or a function of u . On this point see E. Riecke, *Wied. Ann.*, 66, p. 375, 1898; *Ann. der Physik*, 2, p. 835, 1900, and H. Mache, "Boltzmann Festschrift," p. 137, 1904. A possible uncertainty in the value of the factors of σ is here of no importance, as on my theory it does not affect the determination of the ratio of the conductivities for heat and electricity.

18. L. Boltzmann, *Wiener Berichte*, II, 58, p. 517.

kinetic energy of the electrons must, by repeated collisions, have become equal to that of the molecules of the metal; and for the latter, at least, equation (6) must hold; in which case x must have the value it has in the kinetic theory of gases. The value of x can be calculated if Loschmidt's number — the number of molecules in a cubic cm of gas at 0 deg. C and atmospheric pressure — be known; but the quantity x/e is independent of this number and can, therefore, be determined with greater certainty: for, from equation (6) we have

$$\frac{1}{2} \frac{m u^2}{e} = \frac{x}{e} T.$$

In this equation m may be taken as the mass of one equivalent of hydrogen and u as the mean velocity of the hydrogen molecules at absolute temperature T . When $T=291$, that is at 18 deg. C, $u^2=3.605 \times 10^{10}$ if we take cm and second as units of length and time. If H be the mass of an hydrogen atom $m=2 H$ and we get $\frac{H}{e} 3.605 \times 10^{10} = \frac{x}{e} 291$. Now e is that quantity of electricity, which in passing through an electrolyte, liberates a mass H of hydrogen. The ratio e/H has been accurately determined and is 0.965×10^4 ; therefore,

$$\frac{x}{e} = 12.8 \times 10^8 = 12,800 \quad (7)$$

where e is expressed in absolute electromagnetic units.

Relation between Electrical Conductivity and Temperature.

If N , the number of electrons per cubic cm, is independent of the temperature, it follows from equation (5) that the conductivity must decrease as the temperature increases; for the velocity u increases with the temperature, as appears from equation (6); while the time τ between two successive impacts decreases. Making use of equation (6) we may write equation (5) in the form

$$\sigma = \frac{1}{4} e^2 N \frac{l u}{x T}. \quad (8)$$

Since experiment shows that, for a pure metal, σ varies inversely as T , the absolute temperature, we conclude that $N l u$ is independent of T . Therefore, if N is independent of T , the length of free path l must decrease as T increases, being proportioned to $1/\sqrt{T}$. This decrease in l with increasing temperature may be explained

by assuming that the majority of the impacts occur not between the electrons themselves, but between the electrons and the atoms of the metal. The latter, at the higher temperature, have not only greater kinetic energy, but also, according to Clausius' Virial Theorem, greater potential energy; that is to say they move further from the position of equilibrium they occupy when $T = 0$. There is, therefore, less space left between them for the electrons to move about in.

The Electrical Conductivity of Alloys.

From equation (8), we infer that it should be possible to calculate approximately the conductivity of an alloy, if the conductivities of its constituents are known; provided, of course, that N has the same value for a metal when alloyed as when pure. The abnormal increase in the resistance of copper, when it contains traces of sulphur, arsenic or phosphorus, seems to indicate a decrease in the number of free electrons; *that is a decrease in the dissociation of the electrons*. This doubtless has some connection with the electronegative character of these elements, by virtue of which they attract and bind the negative electrons thus decreasing the number N of free electrons, which alone determines the conductivity.

Relation between the Thermal and Electrical Conductivities.

If the conduction of heat is effected solely by the impacts of the electrons, then, according to the principles of the kinetic theory of gases, the flow of heat f , that is the amount of heat carried in one direction, by these impacts across unit cross-section in unit time, is given by the expression

$$f = \frac{u l N}{3} \frac{dw}{dx}$$

where w is the quantity of heat contained in any colliding particle. Now by equation (6), every electron, according to Drude, contains a quantity of heat $w \times T$ (in mechanical units).

Therefore

$$f = \frac{1}{3} \times u l N \frac{dT}{dx}$$

and the conductivity (in mechanical units)

$$k = \frac{1}{3} \times u l N.$$

Dividing by corresponding sides of equation (8) we obtain,

$$\frac{k}{\sigma} = \frac{4}{3} \left(\frac{x}{e} \right)^2 T \quad (9)$$

which is, in effect, the law of Wiedemann and Franz, *that the ratio of the thermal and electrical conductivities of a metal is a constant*. This ratio is, however, by equation (9) proportional to the absolute temperature. The numerical value of $\frac{x}{e}$ is given by equation (7). If k be expressed in thermal units, taking the gram-calorie as the unit of heat, the right side of equation (9) must be divided by Joule's equivalent 4.19×10^7 . Then taking $T = 291$ deg. (= 18 deg. C) we get

$$\frac{k}{\sigma} = 1520 \quad (10)$$

According to the measurements of Jäger and Dieselhorst,¹⁹ this value is correct for aluminum and approximately correct for many other metals and alloys. Thus for silver $k=1.005$; $\sigma=61.4 \times 10^{-8}$; $k/\sigma=1640$. It is also true that for all metals the ratio k/σ is approximately proportional to the absolute temperature. The value of k/σ is always found to be greater than the theoretical value and in one case is as high as 2640. The larger values are found for badly conducting metals and alloys and may be explained on the supposition that, when the conductivity is low, a proportionately greater quantity of heat is carried by other processes than the passage of electrons, as, for example, electromagnetic (Hertzian) radiation²⁰ of the irregular backward and forward movement of the electrons. Equation (9) holds whether N , the number of electrons, is independent of T or not.

Contact Difference of Potential.

If two metals 1 and 2, for which N has different values N_1 and N_2 , are in contact there will be a difference of potential between them. If N_1 be greater than N_2 , the tendency of the negative electrons to pass across the bounding surface by diffusion is greater in the metal 1 than in the metal 2, and metal 1 will be

19. Jäger & Dieselhorst. *Berliner Berichte*, 38, 1899, p. 719. *Wiss. Abhand. der phys.-tech. Reichsanstalt zu Charlottenburg*, 3, p. 269, 1900. Cf. L. Grüneisen, *Ann. der Physik*, 2, p. 72, 1900.

20. When first establishing the law of equation (9), I overlooked this possible explanation and concluded that the deviation in the value of σ from the theoretical value pointed to the existence of at least two kinds of electrons. This assumption is, however, unnecessary.

positive relatively to the other. The value of the contact difference of potential²¹ is

$$V_1 - V_2 = \frac{4}{3} \frac{x}{e} T \log_e \frac{N_1}{N_2}. \quad (11)$$

From the optical behavior of metals (see below) it is inferred that $\log_e \frac{N_1}{N_2}$ is generally less than unity; so, making use of the value of x/e found in equation (7) we get

$$V_1 - V_2 = \frac{4}{3} \frac{x}{e} T = \frac{4}{3} \cdot 12.8 \cdot 10^9 \cdot 291 = 4.96 \times 10^6$$

or $V_1 - V_2 = 0.05$ volts as the upper limit of the value of the contact difference of potential at 18 deg. C.

Thermo-Electricity.

In the case where there are two metallic junctions with a difference of temperature dT between them, we find the e.m.f. dE to be by equation (11)

$$dE = \frac{4}{3} \frac{x}{e} dT \log_e \frac{N_1}{N_2} = 171 dT \log_e \frac{N_1}{N_2} \text{ microvolts.} \quad (12)$$

Here dE is positive when the thermo-current flows from metal 2 to metal 1 at the warmer junction. In establishing equation (12), it is assumed that N_1/N_2 is independent of T . If this is not so dE is not proportional to dT .²²

The Peltier Effect.

The heat W produced in unit time by the current in passing from metal 1 to metal 2 may be calculated at once from equations (11) and (12)

$$W = i (V_1 - V_2) = \frac{4}{3} \frac{x}{e} i T \log_e \frac{N_1}{N_2} = i T \frac{dE}{dT} \quad (13)$$

Here we have Lord Kelvin's formula connecting the Peltier effect and the thermo-electric force. This formula has not, in all cases, been confirmed by experiment. The deviations observed may be explained by assuming the existence of more than one kind of electrons. Whether they can be explained from our present standpoint will not be here discussed.

The Thomson Effect.

When a current flows in a metal from a warm place to a colder, the negative electrons move from a colder to a warmer place.

²¹. This expression I have deduced in *Ann. der Physik*, 1, p. 590, 1900.

²². This point is more fully discussed in *Ann. der Physik*, 1, p. 593, 1900.

Thus the warm place must become cooler as the cold electrons have less kinetic energy than the warm. If, in addition, the number of electrons N is dependent on the temperature; for instance, if it increases with T , then the warmer part will receive a charge at the expense of the colder. That this may be so, the negative electrons constituting the current must be subject to an acceleration toward the warmer part. This effect opposes that before mentioned and tends to increase the heat of the warmer part.

Let Q be the heat, due to the Thomson effect, produced by the current i in an element of volume between whose ends there is a difference of temperature dT , then

$$Q = \frac{x}{e} i dT \left\{ \frac{4}{3} T \frac{d(\log_e N)}{dT} - 1 \right\}. \quad (14)$$

Q is thus produced by the difference of two effects. This explains why it is so small and so much affected by the presence of impurities in the metal; for these have probably a considerable influence in varying $\frac{d(\log_e N)}{dT}$, as appears from the fact, that the temperature coefficient of the electrical conductivity is smaller when there are impurities present.

On the Number and Length of Free Path of the Conducting Electrons in Metals.

From the conductivity σ alone it is impossible to calculate the number of electrons N ; for σ depends not only on N but also on the viscosity of the electrons. If we put

$$\sigma = \frac{N}{r} \quad (15)$$

r will be a measure of the viscosity of the electrons in the metal. We can, however, attempt to calculate N from the optical behavior of the metals. If n be the index of refraction of a metal and k its index absorption for the wave length λ measured in vacuo, then²³

$$n^2 (1 - ik)^2 = 1 + q + 2\lambda c i - \left(\frac{N/r}{\lambda e^2 r} \right) \quad (16)$$

Here i denotes $\sqrt{-1}$; c the velocity of light in vacuo $= 3 \times 10^{10}$ cm per sec; m the apparent mass of an electron; e its charge;

23. Cf. my "Lehrbuch der Optik," German edition, p. 366; English translation by R. Mann and R. Millikan, p. 398; Longmans, Green & Co., London, New York and Bombay, 1902. There e is expressed in electrostatic units; here in electromagnetic; hence the change in the position of e .

q is a quantity, generally real, depending on λ and representing the influence of the bound electrons on the optical properties of the metal. Equating the imaginary parts of equation (16) we get

$$n^2 k = \frac{\lambda c N/r}{1 + \left(\frac{\gamma \pi m c}{\lambda e^2 r}\right)^2} = \frac{\lambda c \sigma}{1 + \left(\frac{2\pi m c}{\lambda e^2 r}\right)^2} \quad (17)$$

Now in the case of light waves $n^2 k$ is, for almost all metals, very much smaller than $\lambda c \sigma$. Thus 1 is negligible in comparison with $\left(\frac{2\pi m c}{\lambda e^2 r}\right)^2$ and (17) takes the form

$$n^2 k = \frac{\lambda^3 c N r e^4}{(2\pi m c)^2} = \frac{\lambda^3}{c \sigma} \left(\frac{N e^2}{2\pi m}\right)^2. \quad (18)$$

Schuster²⁴ recently employed this equation to calculate the number N , introducing the symbol p to denote the number of electrons per atom of the metal. Thus if N^1 be the number of atoms in unit volume of the metal

$$N = p N^1.$$

If we denote by A the atomic volume of the metal, that is the atomic weight divided by the density and by H the absolute mass of the hydrogen atom then

$$N = \frac{p}{AH} \quad (19)$$

$$p \cdot \frac{e}{m} \frac{e}{H} = 2\pi A \sqrt{\frac{c \sigma n^2 k}{\lambda^3}}. \quad (20)$$

The value of e/H , as determined from electrolysis, is $0.965 = 10^4$; while that of e/m is found to be $1.86 = 10^7$ from experiments on the deviation of the cathode rays in a magnetic field. Inserting these values in equation (20) and taking λ as 0.589μ (the D line) we can find p , which for different metals has values lying between 1 and 7.

This method of calculating p is open to the objection that the values found are not independent of λ ; for Minor²⁵ has shown that $n^2 k$ is not proportional to λ^2 . The explanation of this discrepancy may be that the viscosity factor r increases as λ decreases on account of electric radiation.²⁶ If this is so we cannot, for short wave lengths, employ the values of r deduced from the electric con-

24. A. Schuster, *Phil. Mag.*, 7 (6), p. 151, 1904.

25. R. Minor, *Ann. der Physik*, 10, p. 581, 1903.

26. H. Hertz, *Wied. Ann.*, 36, p. 12, 1880.

ductivity. N , however, can be calculated by deriving from equation (16) an equation independent of r . From equation (16)

$$\frac{1}{n^2(1-ik)^2 - 1 - q} = \frac{ir}{2\lambda c N} - \frac{\pi m}{\lambda^2 e^2 N}$$

equating the real parts of the sides of this equation and using equation (19) we get,

$$\frac{\lambda^2 e^2 N}{\pi m} = \frac{\lambda^2}{\pi} \frac{e}{m} \frac{e}{H} \frac{p}{A} = n^2 (k^2 - 1) + 1 + q + \frac{4n^4 k^2}{n^2(k^2 - 1) + 1 + q} \cdot (21)$$

In this equation the value of the term q , depending on the influence of the bound electrons, is unknown; but, if $n^2(k-1)$ is large, a knowledge of the exact value of q is unnecessary and, from what we know of the influence of the bound electrons on n^2 , in the case of insulators, we may for present purposes assume $q=2$. Values of p found thus from equation (21) are almost independent²⁷ of λ . If we put $q=2$ and use my determinations²⁸ of n and k for $\lambda = 0.589\mu$ and follow Planck²⁹ in taking e as 1.62×10^{-20} (i. e., $H = 1.62 \times 10^{-24}$ gr.) we get the values given in the following table:

Metal.	A	p	$N/10^{23}$	$\sigma \times 10^8$	$l \times 10^4$ cm.
Copper	7.1	0.47	4.09	59	1.1
Gold.....	10.2	0.72	4.86	41	0.9
Silver.....	10.3	1.06	6.85	61	0.9
Nickel.....	6.7	1.00	9.21	8.7	0.06
Cobalt.....	6.7	1.45	18.4	10.0	0.06
Iron.....	7.2	1.70	14.6	8.9	0.05
Magnesium.....	13.8	1.92	8.92	20	0.18
Platinum.....	9.1	2.00	18.65	9.2	0.06
Aluminum.....	10.1	2.29	14.0	33	0.2
Cadmium.....	18	2.50	11.9	18	0.1
Zinc.....	9.5	2.88	18.4	16	0.06
Lead.....	18.2	3.27	11.2	4.6	0.034
Mercury.....	14.8	3.39	14.1	1.06	0.007
Bismuth.....	21	3.66	10.8	0.8	0.007
Tin.....	16.2	3.73	14.3	8.3	0.05
Antimony.....	17.9	7.54	26	2.1	0.006

l , given in the last column, is the length of free path for constant current and is calculated as follows: From equations (5), (6) and (19) we obtain

$$pl = \frac{2\sqrt{2}A\sigma}{0.965 \cdot 10^4} \sqrt{\frac{x/e}{e/m} T} \quad (22)$$

From this equation l is calculated for $T=291$.

27. This point is more fully discussed in a paper by the author, *Ann. der Physik*, 14, 1904.

28. P. Drude. *Wied. Ann.*, 39, p. 481, 1890, and 42, p. 186, 1891.

29. M. Planck, *Ann. der Physik*, 9, p. 640, 1902.

J. J. Thomson³⁰ has calculated l from the increase in the resistance of metals in a magnetic field. According to him and from the experiments of Patterson³¹ l has the following values:

Metal.	110° cm.	Metal.	110° cm.
Platinum	0.6	Zinc	2.2
Gold.....	1.6	Cadmium	4.1
Tin.....	1.2	Mercury	1.82
Silver.....	1.2	Bismuth	100
Copper	1.34		

These values of l are considerably greater than those I obtained from the optical behavior of metals. Since the value of pl is known from equation (22) this would entail values of p considerably smaller than those obtained by my method. But the supposition that the values of p are very small is contradicted by the results obtained by Hagen and Rubens³² in their experiments on the emissivity of metals which, for $\lambda = 25.5\mu$, can be calculated from equation (16) on the assumption that $\frac{2\pi mc}{16^2 r}$ negligible in comparison with unity and $1 + q$, in comparison with $2c\lambda\sigma$.

The values of p deduced from the optical properties of metals by means of equation (21) agree fairly well with those deduced from Hagen and Rubens' observations, except in the case of the good conductors, gold, silver and copper, for which metals p must be between 1 and 3 to agree with the observations of these experimenters. The discrepancy is probably due to the influence of the bound electrons; that is to say, the assumption that $q = 2$ led to appreciable error in the calculation.

If we assume for p , in the case of these three metals, greater values than those given in the table, a contradiction to equation (12), giving the thermo-electric force, disappears: for, with the given values of p , the calculated values of the thermo-electric

30. J. J. Thomson, *Rapp. Congress. Internat. à Paris*, tome III, p. 145, 1900. The method of deriving the formulæ there given is open to question as no account is taken of the Hall effect.

31. J. Patterson, *Phil. Mag.* (6), 3, p. 655, 1902.

32. E. Hagen or H. Rubens, *Ann. der Physik*, 11, p. 873, 1903. In the paper quoted above, *Ann. der Physik*, 14, 1904, I have shown how a lower limit for p may be deduced from these experiments.

force, for the metals gold, silver and copper are greater when they are in contact with antimony than with bismuth. This result is contradicted by experiment. If we give p greater values for gold, silver and copper, these metals take approximately their proper places in the thermo-electric series. For other metals, except nickel and magnesium, the values of p calculated from equation (21) on the assumption $q=2$ give values of the thermo-electric force, which agree in order and sign³³ with the actual values.

For an antimony bismuth couple the calculated value of E is 150 microvolts for 1 deg. C. difference of temperature between the junctions; while the observed value lies between 68 and 91 microvolts; and further, as N is, by calculation, smaller in bismuth than in antimony, the thermo-current must, by equation (12), flow across the warmer junction from bismuth to antimony, a result that is confirmed by experiment. By using J. J. Thomson and Patterson's numbers for l we get values of p that give values of the thermo-electric force considerably greater than those actually observed. It is true that Richardson,³⁴ reasoning from premises based on the fact, that glowing metal imparts a certain degree of conductivity to a vacuum, obtains a value of p for platinum 10 times smaller than Patterson's, but in the case of other metals values enormously greater; for example, 10^4 for sodium, 10^7 for copper. The fundamental soundness of these calculations is open to question and there should be some hesitation in accepting such values of p . Nor can I consider satisfactory the method of determining l proposed by J. J. Thomson³⁵ and carried out by Patterson.³⁶ It consisted in determining the minimum thickness of the thin film of metal, for which the conductivity has its normal value. For platinum this thickness is given by Patterson as $0.7 \cdot 10^{-6}$ cm. According to J. J. Thomson this quantity is of the same order as the length of free path l of the electron. But, from the method in which these films were formed, either by a wet chemical process or by deposits of the dust given off by a cathode, it is possible that they lacked coherency, and thus when thin showed too small a

33. This method does not permit of exact evaluation of the thermo-electric force; as the numerical values of q , which shows the influence of the bound electrons, are not known.

34. O. W. Richardson, *Trans. Roy. Soc. of London, Ser. A, Vol. 201*, p. 497; *Proc., Cambridge Phil. Soc.*, 11 (4), p. 286, 1902; *Physik. Zeit.*, 5, p. 6, 1904.

35. J. J. Thomson, *Proc. Cambridge Phil. Soc.*, 11 (2), p. 119, 1901.

36. J. Patterson, *Phil. Mag.* (6), 4, p. 652, 1902.

conductivity. This suggestion receives support from the fact that the resistance of these thin layers decreases as the temperature increases. Thus the thickness for which the conductivity approaches the normal has, perhaps, no connection with the length of free path l and is possibly much greater than it. The method employed, by the author, of determining p and also the length of free path l , from the optical properties of metals also gives uncertain results; firstly, on account of the unknown term q , representing the influence of the bound electrons, and secondly, because, for small values of λ , p may be greater than with constant current. For, if the period of λ approached the natural period of oscillation of the bound electrons, the latter's oscillations may increase in amplitude, and they may even be detached from the atoms, increasing the number of free electrons. If this happens p will be larger for small values of λ than for constant current. In the case of selenium this assumption would explain the decrease of resistance observed under the influence of light. No similar phenomenon has been observed in the case of other metals, and we are justified in assuming that p , the number of conducting electrons per molecule, may depend on the temperature, but not on the wave length of the light falling on the metal.

ELECTRICAL STANDARDS.

BY PROF. DR. WILHELM JAEGER, *Charlottenburg, Germany.*

When we speak of electrical standards, we mean only the standards for the three fundamental units in the electromagnetic system, viz., the ohm, ampere, and volt. For other units, such as those of self-induction and capacity, standards have been prepared; but it is only for the production of the fundamental units that certain definitions have been formed which are usually of a legal nature. These fundamental units are of chief importance. The obtaining of the most careful possible definitions of these units has for a long time been deemed important, and while the endeavors made in that direction have increased as electricity has played a more and more important part in public life, we cannot yet say that the conclusion has been reached. So long as this is the case, and so long as there are with regard to the three fundamental electrical units many open questions calling for solution, can the electrical units deduced from them remain in the background?

The three fundamental units, the ohm, ampere, and volt, have already a certain amount of history behind them, inasmuch as definitions have been made for them at various Congresses, and inasmuch as in many countries legal definitions have been made with a view to their production, their control, and their use in commerce. These definitions diverge considerably from one another, and that not only in a formal manner, but also in points of fundamental importance. To go more closely into the legal definitions would lead us too far; I must pass over them to the review of the different considerations which can determine for us the practical definitions of such units. I shall, therefore, try to express myself as far as possible in the concrete; and to keep myself from criticizing definitions already made, however difficult it may be to do so.

Perhaps I shall succeed, through the close examination of this question, in getting a better grasp of it myself; and thus the advantages will be mutual.

It is often possible from the consideration of analogous cases,

about which judgments have already been formed, to draw conclusions important for the problem under discussion and to illustrate and even to explain the latter by means of the points in which there is agreement or difference as the case may be.

I should, therefore, like to institute a comparison between the fundamental electrical units and the fundamental mechanical units of length, mass, and time which have gone through a development similar to that of the electrical units, and have been for a long time on a satisfactory basis, receiving a treatment recognized everywhere as correct. Even if I draw into this discussion only what is, in my opinion, of importance for the electrical units, it will not be possible to avoid a certain minuteness of detail; however, I shall then be able to express myself more briefly when treating the corresponding questions in the subject of electrical units. Moreover the mechanical units are the basis of the electrical units, and for this reason alone I must now turn back to these units.

In order to put an end to the uncertainty and disorder prevailing in the old systems of weights and measures, an attempt was made to create uniform fundamental measures which from their very definitions could be reproduced at any time, even if they should be lost through some unfortunate accident. The unit of time had long been fixed by the period of the rotation of the planet; then came the idea of deducing the unit of length from the measurement of the same; naturally the unit of mass could not be obtained in a similar way. The meter, accordingly, was defined as the ten millionth part of the earth quadrant; and from this unit of length was deduced the unit of mass, by defining the kilogram as the mass of one liter of water at maximum density (4 deg.). In this way the three fundamental units of mass, length, and time were reduced to two units, by the help of the mass of water which can be obtained pure everywhere. I wish to lay special emphasis on the fact that an attempt was made to reduce the units to two, although the three fundamental mechanical units are completely independent of one another and thus are different from the three electrical units which are bound together by a law of nature that cannot be broken. The intention of creating reproducible standards for length and mass was, in the end, carried out in a manner quite different from that originally planned. When it came to the actual creation of units of length and mass for which, first of all, material standards had to be made, it was soon seen that the unit of length could not be obtained with anything like the same accuracy from the measurement

of the earth as was possible by relative measurement; also the change from length to mass could not be made with the same accuracy. It was, therefore, decided to keep the original definitions for the fundamental standards just so far as these definitions represented the units of length and mass; and then the units thus found, the so-called prototypes, should be declared the real fundamental standards which, independent of their original definition, should count from that time on as the basis of all measurements. Thus was avoided the difficulty of having to make new measurements whenever the standards were used in order to correct the fundamental standards correspondingly; or else — if it were thought best to preserve the continuity of the measurements by preserving the fundamental standard once it was chosen — the difficulty of having to make the reserve that the measurements did not exactly correspond with the definition. These prototypes are kept in Sèvres, near Paris, and a permanent international bureau sees to it that every country which has adopted the system is provided with exact copies of the fundamental standards. The determination of the exact relationship between meter and kilogram, which corresponds only approximately to the definition, was left for later measurements, but the size of the fundamental standard itself was not to be altered in these scientific researches.

No one can deny that all the countries which have adopted the meter and kilogram have placed themselves in a very accessible position and that the basis of the mechanical units is as exact and trustworthy as is possible in the present condition of science.

One question which is also of great importance for the electrical standards must still be touched upon; namely, the question as to what would have to be done if the original standards should be altered or disturbed through any unfortunate accident which could not be prevented by every possible precaution. We do not concern ourselves with the agreement that that would be necessary in such an event, but we must look closely at the various possibilities. In itself the possibility of a gradual change in the prototype is not at all out of the question, whether the change be caused by expansion, oxidation, "wear and tear," or anything else accompanying the use of the prototype. Every one is inclined to accept the absolute constancy of the prototypes without further remark as they are made of the best and most valuable materials, but still such constancy is only a supposition.

The only real criterion which we have for the invariability of the prototypes, which has not been proved, is the relative agreement of these standards with the copies made from them. I consider it important to prove this well founded, as the question is of considerable importance also in the case of electrical units. In principle, no difference exists between the criteria for the invariability of the two standards, which fact, perhaps, is not recognized by many. So long as the prototypes agree with the copies within the possible errors of observation, we are justified, especially if new copies are produced from time to time, in drawing the conclusion from this relative agreement that the original standards and, therefore, the unit have remained unaltered. Otherwise we should have to suppose that all the standards, both prototypes and copies, although made of different materials, have changed in exactly the same manner. A third possibility is not at all a likely one; it is a supposition so improbable that it scarcely need be considered and yet one cannot prove its opposite. If the differences between the standard and the copies should be found to exceed considerably the error of observation, the certainty of the chain of reasoning is lessened. If one or a few of the copies or even the fundamental standard has diverged from all the others, the conclusion would be justified that only this one or only the few differing ones have changed for some reason or other. If the change should be in the original standard, it would be very unfortunate. But then for the preservation of the unit which, having once been chosen, must be kept at all costs, the original standard must be corrected by the copies. There is a great deal of difficulty, diplomatic and otherwise, connected with this matter, but in this case it would be the only right procedure; any plan other than that of preserving the chosen unit intact should not be considered for a moment.

The unit becomes uncertain only when in addition to the discrepancies of individual weights and measures there are great differences between the mean values and the original mean value. When these differences exceed the probable error of observation one is forced to conclude that the standards have in course of time undergone more or less change. In this case the unit would no longer be known with the original accuracy, but there would be an uncertainty amounting to the average discrepancy. It could never be reproduced exactly in its original value, as there would be no way of knowing the amount of change in the fundamental standard. However, it would be wrong to conclude in this case that only the proto-

types had not changed, for that cannot in any way be established. In the case of our fundamental mechanical standards, experience shows that such a thing has never happened. If the preceding observations on the fundamental mechanical standards are carefully considered, the conclusion is inevitable that the original plan must go — the plan of reducing the three units of length, mass, and time to two and of deducing those two from the measurements of the earth — and that instead two material prototypes for length and mass must be produced which are to be considered invariable so long as no serious reason to the contrary is found, and which are to be used by a great many countries as the basis of their standards. There is a true criterion for the constancy of these prototypes in their relative agreement with the copies made from them which copies should be compared with them from time to time. [Recently the meter has been deduced, absolutely, from the lengths of light waves, but the meter of the archives is still kept as the prototype of the unit of length.]

I can now pass to the subject of electrical standards, where still greater uncertainty prevails. We shall find many points of agreement with the mechanical units, as well as some important points of difference.

In the case of electrical units, it is of prime importance that the unit, once chosen, be preserved intact; the demand that it approach as closely as possible the theoretical value is of secondary importance only. In the case of electrical standards, the first requirement can be met in two ways — first, material prototypes may be made as was done for the mechanical standards; second, empirical definitions may be formed which insure, for all time, the possibility of making exact reproductions of the electrical units. The last method, which we have already shown to be of little value for the mechanical standards, seems to be very useful in the case before us. Here each of the two methods completes the other. We must now decide carefully which method best fulfills the requirements.

As the three electrical units are bound together by Ohm's law, which must be exactly fulfilled, apparently it is logically correct to draw up definitions for only two of these units and to deduce the third from these two. Moreover, it is desirable to make as few definitions as possible. Not only is it unnecessary to make a definition for the third unit, but that could be positively injurious as soon as the three units should fail to agree exactly; for, in that case, each pair of the units would yield a different value for the quantity

being measured. Very important reasons must be forthcoming before definitions are drawn up for all three units in the face of the above considerations. As I do not know of any such reason, and as it would be difficult to find one in the following discussion, it is taken as a matter of course that only two units have been made. It is obvious that we can speak here only of empiric definitions; the absolute definition of the electromagnetic practical units is their derivation from the mechanical units ($1 \text{ ohm} = 10^9 \text{ cm sec.}^{-1}$; $1 \text{ ampere} = 10^{-1} \text{ cm}^{1/2} \text{ gr.}^{1/2} \text{ sec.}^{-1}$; $1 \text{ volt} = 10^8 \text{ cm}^{1/2} \text{ gr.}^{1/2} \text{ sec.}^{-1}$) has the same difficulties as occur in the attempt to define the unit of length by means of the earth quadrant. The absolute definition of the fundamental measures is so extremely difficult, takes so much time, and is open to so many errors that great uncertainty would arise in electrical measurements were not empirical definitions called to our aid.

The absolute definition should be merely the basis for the choice of the unit. This unit must correspond as far as possible with the theoretical definition, so that no large corrections should be necessary later. The same method of correction, then, can be carried out by later measurements, as in the case of the relation of the kilogram to the meter, where practical units have been carefully constructed. However, practical definitions must take the place of theoretical definitions in practice. It is not unnecessary to be emphatic upon this point, especially since to adhere too closely to definitions is sure to mean confusion. Carelessness on this point has already caused great difficulties in many places, which difficulties urgently call for removal. It is to be noted that at the close of the Paris Congress of 1881, these ideas carried great weight, since the volt was defined by means of the ohm and ampere (potential drop between terminals of conductor of resistance 1 ohm, with current of 1 ampere). Moreover, it was decided to keep only two units. I will, however, not go further here in this matter.

The question arises as to the manner in which empirical definitions should be made, and also as to which units are to be chosen. There are many opinions on this question alone which make a careful consideration of it necessary. As already pointed out, we have here the question of forming a prototype by the definition of material standards, just as we had in the case of the mechanical units, the question of the creation of reproducible standards; in the latter case the units do not need to be material. When the chief importance is attached to material units, as often happens, only the units of resistance and potential are taken into consideration, as it is impoe-

sible to create in any way a material measure for current. There is nothing to be said against the production of prototypes in electrical standards. In the same manner as in the case of the mechanical standards, and under the same conditions, a standard cell and a standard resistance could be explained as international prototypes of resistance and potential. This plan has been adopted, although never in an international agreement; I need remind you only of the British Association Unit, "B.A.U.," which was in use for a long time, but which in the end did not prove as satisfactory as was at first hoped. In the lapse of time there appeared serious discrepancies between the original standard and the copies, so that the unit became uncertain, as was before described. To-day, even the prototypes have not altogether disappeared from the definitions. There do not seem to me to be reasons of a really logical nature for desisting from the production of prototypes in electrical science, although it would have been absurd to lose the whole advantage of reproducibility if that can be secured with desirable accuracy. In these matters the accuracy of the measure itself plays an important part, as also the uncertainty respecting the constancy of the same. Certainty here can be reached only after some experience.

We will occupy ourselves, therefore, only with the empiric definitions for the reproducible standards. All are unanimous in upholding the definition of the unit of resistance which makes it depend on the resistance of mercury at 0 deg.; in defining the unit of current by its electrical effect as shown in the silver voltameter, and in passing the unit of e.m.f. on the potential drop in a well-defined standard cell. Other definitions, such as those which depend on the current through an ammeter or the potential drop in a voltmeter, provide no reproducible standards, and may, therefore, remain unnoticed.

Although the above-mentioned empirical definitions appear to be fairly exact, they still leave no small latitude, as will shortly be shown, in their applications. For this reason we will now consider the unit of resistance. The definitions made for the unit of resistance at first seem to be somewhat complicated (mercury column of length, 106.3 cm, and of mass, 14.4521 gr. at 0 deg.), but it will be understood that they are only another more exact expression for the derivation of the units from the Siemens mercury unit; the so-called international ohm was fixed at Chicago Congress in consideration of the absolute ohm definition at 1.063 Siemens units in contradistinction to the legal ohm which was fixed by the Paris Electri-

cal Congress at 1.06 Siemens units. The Siemens mercury unit had been well preserved, and the hopes that this unit might prove to be easily reproduced have been fulfilled, even exceeded. The Siemens unit was defined as the resistance of a mercury column 1 sq. mm in cross-section and 1 meter long, at the temperature of melting ice. In the case of the international ohm, the requirement that the mass of the mercury column should amount to 14.4521 gr. is equally important with the fact the section of the column is to be 1 sq. mm. Circumstances caused the choice of the mass instead of the section, so that the section is found by weighing the quantity of mercury between the ends of the closed tube. The mass passes directly into the determination of the resistance; the section of the tube is to be calculated from the mass of the mercury and with the help of the density of the same, also with reference to the kilogram and meter. In order to be independent of these constants, which could cause, in the lapse of time, changes because of new measurements, the mass of the mercury has been incorporated in the definitions, which is really quite correct.

In accordance with such considerations, definitions have been obtained which show the connection with the Siemens unit. According to these definitions of the unit of resistance which are generally recognized and about which no diversity of opinion exists, enough data have not been given for the practical production of the unit. It is well known that to the real resistance of the mercury tube we have to add the so-called end resistance, when the current of the tube is led through terminal vessels which contain potential leads. This end resistance amounts to about 1 part in 1000 of the whole resistance, for the average size of the mercury tube. Nothing is said in the definitions about the size of the factor to be used for the calculation of the end resistance, also nothing is said about the shape of the terminals and the character of the current leads. If we wish to satisfy the requirement that the practical units should approach as nearly as possible the theoretical unit, the best way is to attempt to retain the conditions of the absolute measurements which are at the basis of the definition. In the case of the unit of current we shall have to return to this. But since in the absolute measurements the accuracy is not as great as in the case of the empirical standards, so a certain freedom is allowed in the use of the definitions which one tries to limit partly by the so-called specifications. In the case of the unit of resistance such rules are altogether wanting; but the uncertainty arising from this is not considerable as it can only

amount to some hundred thousandths; still, on the other hand, the mass of mercury which corresponds to 1 ohm is given to the nearest 100,000th. For the surface resistance 0.80 is now usually chosen, and this, according to Dorn, seems the best value. Still it is possible that the number is incorrect by a few per cent. It only counts also for infinite extension in the supposition that the terminals of the tube are formed from flat surfaces and that the edges are very sharp at the passage of the mercury column in the end vessels. These considerations are not always carried out in all strictness. The shape of the terminal vessels, and the kind of current lead as well as the position of the potential, will all affect the value of the end resistance. The uncertainty caused by these different factors is to be estimated at some hundred thousandths; but the definitions for the quantity of mercury are much more nearly correct. The attempt has been made accordingly to avoid the end resistance altogether; still to my knowledge no practical method has been worked out.

A further difficulty of a more formal nature arises in the copying of the mercury unit. It is only through the copying of this unit that it becomes of practical importance, since it can never be used itself for the measuring of anything any more than the meter prototype can, for the simple reason that it would be found inconvenient to use. It is apparent that a certain individual error remains respecting every carefully produced and geometrically measured mercury standard, whether through calibration, length measurement, or mass measurement, although with necessary care this would not amount to more than some hundred thousandths. These errors arise at every filling of the tube with mercury. We can obtain agreement between the different fillings of the tube, only if the tube is cleaned and dried most carefully and the filling is done *in vacuo*; the latter condition is particularly important. The electrical comparison can be made between the tube resistance and the wire resistance if the tube is at a temperature of 0 deg., with an accuracy of 1 part in 1,000,000, also with approximately the same accuracy which is reached by the intercomparison of wire resistances. The accuracy which is to be secured in the case of a single mercury standard and a single filling of the same is considerably less than the accuracy of the electrical measurement. In order to meet the before-mentioned requirement, viz., that of keeping the chosen unit unchanged, the mercury unit can be constructed in different ways without our being able to say beforehand which would be most cor-

rect. One can settle on the form of the prototype to produce a single mercury standard.

The invariability of this unit must be proved as in the case of mechanical standards by making frequent comparisons with the copies of the same (mercury or wire resistances). If the unit were lost, or if important differences were found, it could be restored to within 1 part in 100,000. On account of the delicacy of the mercury standard, several tubes are generally produced, so that the average of this tube and of several fillings could be considered the unit of resistance. If we lessened the individual error of the same, we would also give up the original unit. This has certain formal, perhaps also legal, difficulties. Still for electrical units such considerations must be placed at one side, since it is quite impossible to establish a material standard for a unit of current, as it is for a unit of time. It seems advisable to follow the above-mentioned plan in the light of experience. It is very fortunate that in the case of the unit of resistance we have the valuable assistance provided by the use of manganin resistances. Without these resistances, which are so easy to construct with accuracy, the mercury unit could never have become useful. The invariability of the mercury unit itself, i. e., of the mean value mentioned above, can be controlled only by the production from time to time of new standard tubes or by the comparison of the unit with the copies as we described above for the mechanical units. The latter method suffices on account of the excellent character of the manganin resistances; it would have to be replaced by the former only if relative changes between the different resistance standards (mercury and manganin resistances) should become apparent.

In this case we can turn back to the reproducibility of the resistance unit which is not possible in the case of the mechanical units; but now it is pleasant to know that there is no reason for doing that, as the manganin resistances alone make possible the retention of the chosen unit of resistance. If these resistances are properly made and properly aged, the mean value of several of them, as experience has shown, can be used in place of the mercury unit for a long time. At the same time, I should like to emphasize the valuable character of the manganin resistance for measurements as its temperature coefficient is very small, having a mean of about $+0.000002$, also the terminal effect of manganin on copper is very small. These resistances form, therefore, a very valuable secondary standard for the unit. The relative constancy of all the resistances

is the only criterion of the values of the unit once chosen. For itself alone one could not accept the invariability of the mercury standards without further study. This must be shown by experience, just as much as in the case of wire resistances. This proof of the relative invariability can be supported when necessary by the reconstruction of the mercury standards. According to experience, so far as I know, no change in a mercury unit has been observed.

If the conditions of the standard cells were just as favorable as in the case of resistances, there would not be any doubt about using this convenient standard as the unit of e.m.f. In the meantime the inaccuracy of the standard cells is considerably greater, even though one seems to be able to go much farther into the subject. At present the inaccuracy which arises through the order of the agreement of different standard cells and at different times amount to about 1 part in 10,000; the reason is, first of all, to be found in the action of the mercurous sulphate which gives different e.m.fs. in different states, but other factors also come into consideration. The standard cell is a very complicated chemical system which can easily show differences under careful and minute specification. If it is possible to reach a greater agreement through the improvement of the materials, especially the mercurous sulphate, it would be some time before one could say anything certain about the constancy of these cells. It is the general opinion that in time cadmium sulphate cells will be used, as these cells are far better in many respects than the Clark cells, and afford every measurement in consequence of their low temperature coefficient. On the other hand, one must notice that there are two kinds of cadmium cells, one with an excess of crystals and the other as made by the Weston Company, with a solution of cadmium sulphate which is saturated at about 4 deg. We must allow that it would be desirable to have in the standard cell just as easy a measurement of e.m.f. as the manganin resistances with respect to the mercury standards are for the units of resistance. Still for the present we shall be obliged to do without.

Nothing remains now except to use the unit of current strength, which is determined in the well-known manner by the silver voltameter, as a secondary unit. With the definition that 1 ampere in 1 second (1 coulomb) deposits 0.001118 gr. silver from a solution of silver nitrate, more minute specifications should be given. With the use of the silver voltameter the following consideration must be heeded: The same condition must hold as in the absolute measurements from which the above number was taken. It would,

therefore, for example, not be allowed to carry out the measurement with the silver voltameter in an absence of oxygen; in which case one would get values differing from the measurements taken in the air by 1 part in 1000. Even if these conditions for the preservation of the right equivalent weight of the silver have been secured, they may not be used for their present purpose, because they are not in the absolute measurement.

The accuracy obtainable by the silver voltameter by following the special rules can be estimated at 1 part in 1000. One might expect that through a further study of the silver voltameter and through the removal of some sources of error the accuracy could be further increased. If one considers these remarks, one will come to the conclusion that it seems advisable to consider the mercury standards and the silver voltameter as the fundamental electrical measures, and with their help to create secondary standards, especially manganin resistances and standard cells. If a certain standard is to be had, one can draw conclusions about its absolute invariability from their agreement. It would be desirable that in the different countries the same point of view should be kept and that all should work toward the agreement of the fundamental units through repeated comparison of the same. As we have seen, some points are at present still on hand to make a further study desirable. In the first place, the silver voltameter is capable of further improvement, then also the standard cells which play so important a part in the science of electrical measurements. Perhaps further experiments about the end resistance would not seem unnecessary. Very considerable improvements have been made in these last years in the subject of electrical units. It is to be hoped that these will be increased through the institutions which are dedicated to the care of electrical units in many countries.

ON MAGNETOSTRICTION.

BY PROF. H. NAGAOKA, *Imperial University, Tokyo, Japan.*

Since the discovery by Joule in 1842 that iron changes its dimension by magnetization, the magnetostriction of ferromagnetic bodies has attracted the attention of experimental and theoretical physicists. The measurements usually undertaken relate to the changes of length and of volume, but associated with them comes the Wiedemann effect, which is measured by the amount of torsion caused by the interaction of circular and longitudinal magnetizations. A singular characteristic of magnetostriction is its reciprocity with the effects of stress on the magnetization of different ferromagnetic substances, so that some of the effects, such as the Villari critical point in iron, seem to foreshadow the nature of the strain, which would be wrought by magnetization. The correlation between stress and strain in the magnetization of ferromagnetic substances opened a new field of research, which resulted in laying the foundation for the dynamical discussion of the phenomena. The hysteresis attending the magnetostriction is generally complicated, and presents great difficulty in establishing a really satisfactory theory of the subject.

In the course of experimental researches on magnetostriction, questions of various character present themselves, both as regards the method of measurement and the nature of the sample. The minuteness of the effect calls forth precautions against diverse sources of error, such as the non-homogeneity of the magnetic field and the mechanical forces arising therefrom, the non-uniformity of temperature, a slight disturbance of which would in most cases be sufficient to mask the strain, which we are seeking after. All these different sources of error, however intricate they may at first appear, can, by properly arranging the measuring apparatus, be eliminated. Apart from these instrumentalities, the diversity in the character of magnetostriction with different samples is hardly to be avoided; even the mechanical and thermal treatment to which the sample was subjected leaves its trace in the strain caused by magnetization. The changes of length and of volume in the alloys

of two ferromagnetic bodies, nickel and iron, which as regards the change of length by magnetization are of opposite character in weak fields, are not according to the relative proportion of the magnetostriction of the constituents, but the phenomena are of a much complex character.

The effect of temperature in modifying the character of magnetostriction is of great importance, but belongs to a most difficult part of the investigation; our knowledge of the subject is as yet limited to the effect on the change of length, and awaits further investigation of the subject.

As the theory is still in its infancy, I shall in the following take a brief survey of our experimental knowledge on magnetostriction, including some new results which have not yet been published.¹

1. CHANGE OF LENGTH BY MAGNETIZATION.

On account of the extremely small change of length, the method of interference fringe or of optical lever is used in measurement. Quite recently the method of electric micrometer was used by Shaw.

The delicacy of interference fringe can be utilised for experiments in fields of low intensity, but it is not suitable for measurements in strong fields, as it is difficult to count the number of fringes within the interval of time during which a magnetizing current can be passed in the coil without heating the ferromagnetic body under examination. An optical lever can be so arranged as to give the same sensitiveness as that obtained by the interference method. With special optical appliances, we can easily measure a displacement of 0.01μ , which it is usually necessary to measure. The utmost precaution is required in all these measurements to guard against inequalities of temperature; I have used a compensation method analogous to gridiron pendulum, to avoid the errors, which are likely to creep into the measurements. Usually observations are made in so short a time that the heating of the coil is negligibly small. In testing the hysteresis, however, it is necessary to observe continuously during a magnetic cycle, and we are obliged to have recourse to the compensation method.²

1. For the literature on magnetostriction up to 1900, the reader is referred to "*Rapports présentés au Congrès international de Physique réuni à Paris.*" tome, 2, 1900. Only references subsequent to that date are given in the present paper. See also article "Magnetism" by Bidwell, *Encyclopedia Britannica*, Vol. xxx, p. 441.

2. The apparatus for measuring change of length in ovoids is exhibited in the Japanese section of St. Louis International Exposition.

It is much to be regretted that little care was taken by some observers to eliminate the mechanical force which would be brought into play by placing the magnetized body in a heterogeneous field; cases occur where the wire is of the same length or even longer than the magnetizing coil. Another fault lies in the choice of a specimen whose demagnetizing factor is large; the result is then only true for small magnetizing force, although the external force may be tolerably large.

Experiments by Bidwell revealed for the first time the various features in the change of length in iron, nickel, and cobalt. As these were mostly experiments on wires, rods, or rings, I have, with Mr. Honda, extended the investigation with ovoids ($a = 0.5\text{cm}$, $c = 10.0\text{cm}$) in uniform fields up to 2,000 units, and found qualitative coincidence with his results. Further experiments with cobalt in cast and annealed states showed great difference in the behavior as regards magnetization and the change of length caused by it; nickel steels of different percentages indicated remarkable variation as the percentage of the constituents is altered.

(a) *Iron*. In low fields, the ovoid elongates and reaches a maximum, whence it diminishes till it indicates no elongation ($H = 200$). The decrease goes on at a slowly diminishing rate, and ultimately assumes an asymptotic value. The maximum elongation varies with the specimen and lies between 3×10^{-6} and 5×10^{-6} of its length.

Steel. The length change in ordinary and tungsten steel resembles iron with a slight difference in quantitative details.

(b) *Nickel*. Nickel shows diminution of length; the contraction takes place at first slowly but gradually at an increased rate. Between the fields 5 and 100, the rate of diminution is very rapid, but the change becomes at last asymptotic, when it amounts to about 38×10^{-6} in $H = 2,000$.

(c) *Cast Cobalt*. The behavior of cast cobalt as regards the length change is similar to that of nickel in weak fields. Instead of reaching an asymptotic value as in nickel, the contraction of cobalt reaches a maximum at $H = 160$, from which the metal gradually recovers with increase of field strength, till it attains its initial length in $H = 750$. The metal goes on increasing in length at a less rapid rate up to $H = 2,000$. Representing the change of length by means of a curve, we notice a singular trend somewhat resembling the inverted form of the curve for iron.

Annealed Cobalt. By annealing cast cobalt, the surface color turns ashen gray, and the permeability of the metal diminishes in a remarkable degree. The diminution of length by magnetization takes place at first slowly, but goes on steadily increasing till it amounts to 25×10^{-6} for $H = 2,000$. The curve representing the change approximates to a straight line.

(d) *Nickel Steels.* The length change in nickel steels of different percentages does not follow the law of proportionality of the respective constituents. All the nickel steels containing 24 to 70 per cent of nickel show increase of length up to $H = 2,000$. The behavior of 24.04 to 46 per cent alloys is similar as regards the change of length and does not indicate the existence of maximum elongation. It is, however, to be remarked, that the rate of increase diminishes as the percentage increases. Ultimately, with further increase of nickel, the maximum elongation makes its appearance, and is already present for a 50.7 per cent specimen in $H = 1,000$; with 70.3 per cent nickel it appears in $H = 170$. The increase of nickel beyond 50 per cent displaces the maximum point in the direction of the lower field. In fact, the character of the change resembles that in iron. With further additions of nickel, the metal will show contraction, which goes on increasing with the field. This remarkable change in the character of the elongation takes place when the metal approaches pure nickel. Further, it is to be noticed that the elongation in all these specimens exceeds that of constituent ferromagnetics. The greatest elongation amounts to 25×10^{-6} in 46 per cent nickel, while in 25 per cent nickel, which is almost non-magnetic, the elongation is immeasurably small.

(e) *Bismuth and other substances.* Bidwell, Van Aubel, and others tested the change of length in bismuth, and did not arrive at a conclusive result; quite recently Shaw showed that the change of length in practically non-magnetic substances is nil.

The accompanying figures show the intensity of magnetization and the changes of length³ in different fields ($H =$ external field — demagnetizing factor \times intensity of magnetization) for iron, steel, cobalts, and nickel steels.

3. Literature on the change of length by magnetization:—Nagaoka a. Honda, *Journ. Coll. Sci. Tokyo*, 13, 57, 1900; Shaw a. Laws, *Electrician*, 46, 649, 738, 1901; Austin, *Phys. Rev.* 10, 180, 1900; Nagaoka a. Honda, *Nature*, 65, 246, 1902; *Comptes Rendus*, 134, 536, 1902; Rhoads, *Phil. Mag.* 2, 463, 1901; Nagaoka a. Honda, *Phil. Mag.*, 4, 45, 1902; Honda a. Shimizu, *Phys. Zeit.*, 3, 378, 1902, *Phil. Mag.*, 4, 338, 1902; Wills, *Phys. Rev.*, 15, 7, 1902; Van Aubel, *Phys. Rev.*, 16, 60, 1903; Shaw, *Proc. Roy. Soc.*, 72, 370, 1903; Nagaoka a. Honda, *Journ. Coll. Sci., Tokyo*, 19, Art. 11, 1903.

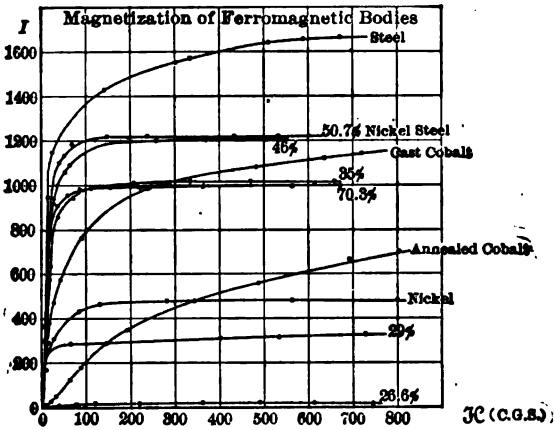

FIG. 1.

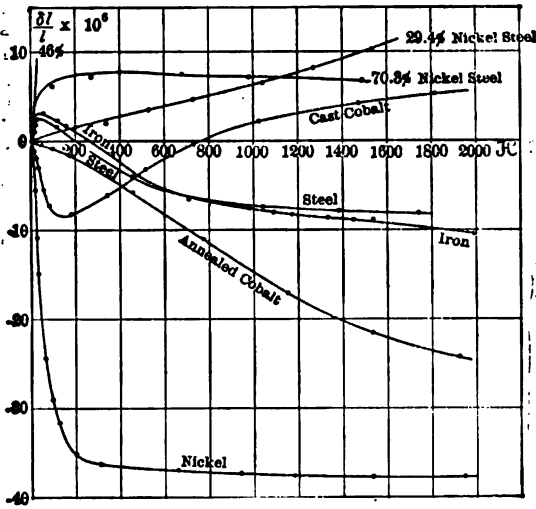

FIG. 2.

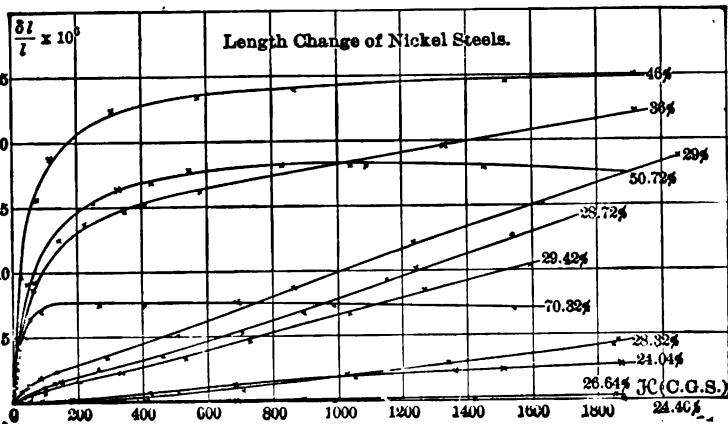

FIG. 3.

Effect of tension on the change of length. By suspending the weight to the wire under examination, we can easily observe the effect of tension on the change of length. Bidwell showed that loading brings down the maximum in an iron wire, and finally makes the wire always contract. Steel is similarly affected by tension as in iron. The contraction in nickel is generally diminished by loading, while in nickel steels, there is continuous diminution of elongation by increasing the tension.

An interesting experiment by Rhoads shows that a rolled or stretched sheet of iron shows a different behavior as regards the length change, showing that the previous history is still to be traced in magnetostriction.

Effect of temperature on the change of length. The subject was studied by Honda and Shimizu⁴ between the temperatures ranging from -184° to 1200° , by means of a special optical lever. A fine wire which is attached to one end of the rod is wound round a small cylinder which carries a mirror. The displacement of the ovoid or rod causes a small rotation of the cylinder, which is read by the Poggendorff method. The specimen was dipped in liquid air or electrically heated by means of a coil wound anti-inductively. The result seems to have an important bearing on the theory of molecular magnetism, so that it would not be superfluous to enumerate the principal results.

(a) *Iron.* As the temperature is raised, the contraction in high fields gradually disappears, and at 312° the change of length is similar to that in tungsten steel at ordinary temperature. With further increase of temperature, the elongation, after passing a maximum, gradually decreases. The elongation can be traced to 970° , which is far higher than the critical temperature for magnetization. The effect of cooling by liquid air is considerably large in strong fields, producing an increase of contraction. The maximum elongation in weak fields, which is characteristic for iron, remains constant for temperatures ranging from -184° to 200° . Above this temperature, the elongation increases, till it reaches a maximum, and then rapidly decreases.

Tungsten Steel. The course of curves for elongation and its change with temperature are similar to those of soft iron at temperatures higher than 500° . The change of length disappears at the critical temperature, which is about 900° . Cooling decreases the elongation in weak fields, but increases it in the strong.

4. *Journ. Coll. Sci.*, 19, Art. 10, 1903.

(b) *Nickel*. The rise of temperature markedly reduces the magnetic contraction of the metal. At a temperature of 240° , the contraction in $H = 800$ is already reduced to half its ordinary value, and at 400° it almost vanishes. In liquid air, the contraction is reduced in weak fields, but is increased in the strong.

(c) *Cast Cobalt*. As the temperature is raised, the magnetic contraction in weak fields gradually lessens and the elongation in strong fields increases, till it attains a maximum. At temperatures higher than 800 , the initial contraction altogether disappears, and the course of the curve resembles that in iron and steel at high temperatures. If the temperature be further increased, the elongation diminishes steadily, but at a diminishing rate and even at 1020° , we still observe a considerable elongation of the metal. It is also to be noticed that the field of maximum contraction gradually decreases as the temperature is raised, and that the temperature of maximum elongation in a given field diminishes as the field is increased.

Annealed Cobalt. As the temperature is raised, beginning with that of liquid air, the contraction increases at first slowly, and then rapidly till it reaches a maximum. It then decreases, and after passing the state of no contraction, it is changed to an elongation, which again increases with the temperature up to a maximum, and then gradually diminishes. At such a high temperature as 1034° , we can still observe a considerable elongation of the metal. It is interesting to observe that the curve of length change at a temperature near to 450° is similar to that of iron at ordinary temperature. At a temperature higher than 500° , the cast and annealed cobalts resemble each other in their behavior as regards the change of length.

(d) *Nickel Steels*. At the temperature of the liquid air the elongation diminishes in the weak but increases in the strong. Our knowledge on the effect of high temperatures is still wanting.

On comparing the results in soft iron, tungsten steel, cast and annealed cobalts, we notice the remarkable fact that the changes of length by magnetization of these metals are, at ordinary temperature, so very different from each other, but assume, at sufficiently high temperatures, an extraordinary simple character; they then tend to become proportional to the magnetizing force.

Hysteresis accompanying the change of length by magnetization.
— The hysteresis is of a very complex character; graphically represented, the curve of hysteresis is symmetrical about the line of

zero magnetizing force, and presents four loops during a complete magnetic cycle. Rhoads⁵ found remarkable coincidence of hysteresis in thermoelectric power of magnetized iron with that due to elongation by magnetization. The accompanying diagram will clearly illustrate the nature of hysteresis.

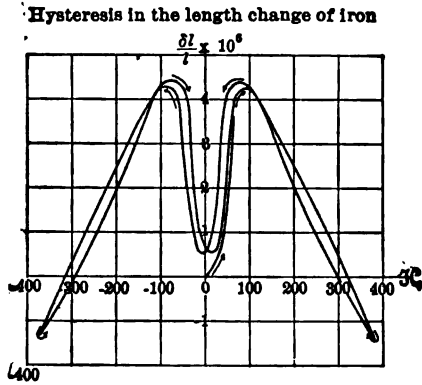

FIG. 4.

2. CHANGE OF VOLUME BY MAGNETIZATION.

Joule showed that there is no change of volume by magnetization; Cantone was the first to notice a slight change of volume in nickel. The change in the internal volume of ferromagnetic tubes was observed by Knott; Bidwell showed indirectly with iron rings that the volume change must exist. On experimenting with iron, nickel, and nickel steel ovoids, I, with Mr. Honda, found that the change of volume, though very small, may ultimately become tolerably large in strong fields, so that the motion of capillary meniscus of a dilatometer can sometimes be followed by the naked eye. In experimenting with the volumenometer, extreme care is necessary to place the ovoid axially in the magnetizing coil, and to keep it free from the wall of the dilatometer tube. Non-uniformity of the field may become another source of error which has often been neglected. Although the magnetizing coil is water-jacketed, the lack of temperature compensation makes it difficult to observe the change continuously, so that the motion of the liquid must be almost instantaneously measured after making the current. In some of the metals, the change is almost instantaneous, but in a few specimens we noticed a distinct time lag.

5. *Phys. Rev.* 15, 321, 1902.

Iron, steel, and nickel.— In all of these metals, there is a slight increase of volume amounting to about one-millionth in iron and steel, and one-fourth of that amount in nickel.

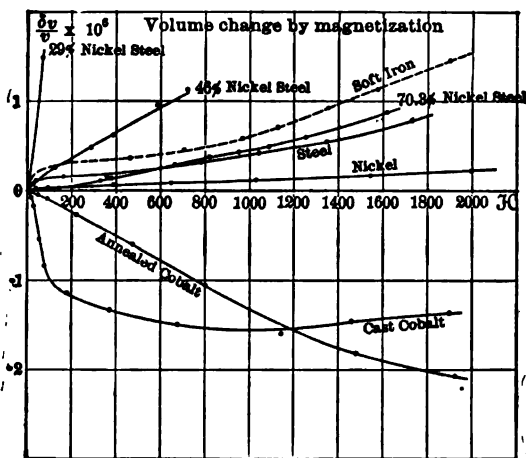

FIG. 5.

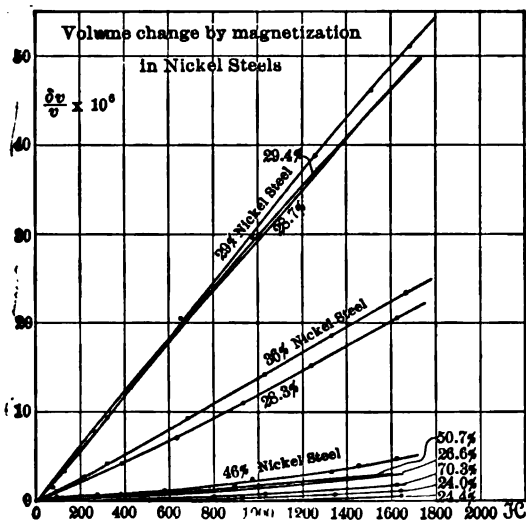

FIG. 6.

Cobalt.— Cast cobalt shows diminution of volume at a rapid rate in low fields, but above $H = 100$, the rate becomes less, and the contraction reaches a maximum in $H = 900$, whence to decrease

gradually with increase of the field. Annealed cobalt contracts in volume at a steady rate as the field is increased. The contraction ultimately becomes greater than in cast cobalt.

Nickel steel.—The volume change in nickel steels is characterised by its simplicity, being approximately proportional to the magnetizing force, and its amount greatly surpasses that in ferromagnetic substances before mentioned. The accompanying figure gives the change of volume in nickel steels containing different percentages of nickel. The change in 29 per cent nickel steel is nearly 40 times greater than in soft iron. Even the 25 per cent nickel steel shows a volume change, which, in spite of its minute magnetizability, could be distinctly measured by a microscope.

When we consider the magnitude of the volume change in nickel steels, and compare it with that observed in iron, nickel, and cobalt, we are but struck with the immensity of the effect, which is not shared in such an extraordinary degree by either of these constituents of the alloy. The same remark applies to the magnetizability of some of the samples. Generally speaking the volume change by magnetization is of a differential nature, since

$$\text{Volume change} = \text{Elongation parallel to magnetization} + 2 \times \text{Elongation perpendicular to magnetization.}$$

The elongation in the direction of magnetization is of opposite sign to that in the direction perpendicular to it. In iron and nickel, the sum of these elongations representing the volume change nearly vanishes, while in nickel steels, this is by no means the case. The sum of these respective elongations is maximum in 29 per cent nickel steel, in which the position of maximum effect is very prominent. The border line which marks the transition of nickel steel from *acier dur* to *acier doux* is little short of the same percentage, which will probably account for the existence of the maximum change of volume considered as a differential effect.*

3. TWIST PRODUCED BY THE INTERACTION OF CIRCULAR AND LONGITUDINAL MAGNETIZATIONS.

The direction of twist in iron, so long as the magnetizing field is not strong, is such that if the current is passed down the wire from the fixed to the free end, and the wire is magnetized with north pole upwards, the free end, as seen from above, twists in the

* Literature on volume change by magnetization:—Quineke, *Berl. Ber.*, 20, 391, 1900; Nagaoka a. Honda, *Journ. Coll. Sci.*, 13, 57, 1900; *Nature*, 65, 246, 1902; *Phil. Mag.*, 4, 45, 1902; *Comptes Rendus*, 134, 536, 1902; *Journ. Coll. Sci.*, 19, Art. 11, 1903.

direction of the hands of a watch. By keeping the circular field constant, the amount of twist increases at first till it reaches a maximum, in a field of about 20 units; it then goes on diminishing till it ultimately changes the direction, and continues to twist in the opposite direction with increasing field. In nickel, the direction of twist is opposite to that in iron, the only difference being that even in fields of great strength, the twist is not reversed. In cobalt, the Wiedemann effect resembles nickel, but the direction of twist is reversed in strong fields. The direction of twist in nickel steel is the same as in iron; the twist reaches a maximum, whence to decrease gradually as the field is further increased. Generally the Wiedemann effect is diminished by loading the wire or rod.⁷

4. RECIPROCAL RELATIONS AND THE THEORY OF MAGNETOSTRICTION.

The effect of longitudinal stress, of hydrostatic pressure and of twist, on the magnetization of ferromagnetic substances, stands in reciprocal relation with the elongation, the change of volume, and the twist produced by magnetization respectively. Instead of describing the results of various experiments on the effect of stress, the following parallel statements will elucidate the mutual relations at a glance.

STRAIN PRODUCED BY MAGNETIZATION.

1. Longitudinal magnetization produces increase of length in iron till it reaches a maximum, thence to diminish gradually with increasing fields till the length becomes shorter than in the unmagnetized condition.
2. Longitudinal magnetization produces continuous diminution of length in nickel up to high fields.
3. Longitudinal magnetization in cast cobalt produces diminution of length in low fields, which after reaching a maximum gradually lessens, and finally produces increase in strong fields.
4. Longitudinal magnetization in annealed cobalt produces diminution of length, which gradually increases with the strength of the field.

5. Longitudinal magnetization produces increase of length in nickel steels.

7. Literature on Wiedemann effect:—Barus, *Sill. Jour.*, 10, 407, 1900; *II*, 97, 1901; *Phys. Rev.* 14, 283, 1901; Nagaoka a. Honda, *Journ. Coll. Sci.*, 13, 283, 1900; *Phil. Mag.* 4, 45, 1902; Honda a. Shimuzu, *Phy. Zeit.*, 577, 1902; Jouaust, *Eclair. Electr.*, 34, 185, 1903.

VOL. I—23

EFFECT OF STRESS ON MAGNETIZATION.

1. Longitudinal pull produces increase of magnetization in iron till it reaches a maximum, thence to diminish till the magnetization becomes less than in the unstretched condition.
2. Longitudinal pull produces diminution of magnetization in nickel up to high fields.
3. Longitudinal pull in cast cobalt produces diminution of magnetization in low fields, which after reaching a maximum gradually lessens, and finally produces increase in strong fields.
4. Longitudinal pull in annealed cobalt produces diminution of magnetization, which gradually increases with the strength of the field.

5. Longitudinal pull produces increase of magnetization in nickel steels.

6. Longitudinal magnetization produces minute change of volume in iron, nickel, cobalt, and nickel steels.

7. A longitudinally magnetized wire is twisted by circular magnetization.

8. A circularly magnetized wire is twisted by longitudinal magnetization.

9. Up to moderate fields, the twist produced by the longitudinal and circular magnetizations of an iron wire is opposite to that in nickel.

10. The twist due to longitudinal magnetization of a circularly magnetized iron or nickel wire reaches a maximum in low fields.

11. In strong fields, the twist due to longitudinal magnetization of a circularly magnetized iron wire is reversed and takes place in the same direction as in nickel.

6. Hydrostatic pressure produces minute change of magnetization in iron, and nickel (cobalt and nickel steels not yet tested).

7. Twisting a longitudinally magnetized wire gives rise to circular magnetization.

8. Twisting a circularly magnetized wire gives rise to longitudinal magnetization.

9. Up to moderate fields, the transient current or the longitudinal magnetization produced by twisting a longitudinally or circularly magnetized iron wire resp., is opposite to that in nickel.

10. The transient current produced by twisting a longitudinally magnetized iron or nickel wire reaches a maximum in low fields.

11. In strong fields, the direction of the transient current produced by twisting a longitudinally magnetized iron wire is reversed and is in the same direction as in nickel.

The reciprocal relations coordinating the strains produced by magnetization and the effect of stress on magnetization, as found by actual experiments, will be found to be of great importance in arriving at a correct theory of magnetostriction. In his valuable work on the applications of dynamics to physics and chemistry, Prof. J. J. Thomson has propounded a new method of investigating the mutual relations between the effects of various physical agencies. He showed that the existence of a certain phenomenon involves as a natural consequence that of another reciprocating with it. Most of the relations above cited can be simply elucidated by considering the ferromagnetic body carrying an electric current as an approximate dicyclic system, and developing most of the above relations as consequences of dynamical theorems.

The stress which would be brought into play by the magnetization of a ferromagnetic body was first discussed by Maxwell; the theory was extended by Helmholtz and notably by Kirchhoff. The peculiar feature of Kirchhoff's theory lies in the simple and natural way of elucidating the relations between the various kinds of strain caused by magnetization and the effects of stress on magnetization. Just as we can study the various elastic behavior of isotropic bodies by knowing the bulk and stretch moduli, we have to deal, in Kirchhoff's theory, with two strain coefficients, which play the rôles of different moduli in the theory of elasticity. Later developments by

Hertz, Pockels, Sano, and Kolacék, are more or less extensions of Kirchhoff's idea. They generally show qualitative coincidence, but fail to give quantitative details of the phenomena. The theories, numerous as they are, have one common defect; they put at the outset either explicitly or implicitly that there is no hysteresis in the phenomena in question. This rough approximation seems to be the principal cause of the discrepancies between theory and experiment. It is moreover to be remarked, that the greatest difficulty in establishing the relations between the effects of stress on magnetization and the strain caused by magnetization lies in the great difference of strain coefficients, according to the nature of the specimen. If all the experiments be performed in a proper manner on one and the same specimen of ferromagnetic metals, we may feel assured of being able to discern the true merits of the theory, or to detect its various defects, not only from qualitative points of view, but also in quantitative details.

CONCLUDING REMARKS.

Closely connected with magnetostriction is the question of the change of elastic moduli by magnetization. Experiments by Noyes, Brackett, Stevens, Tangl, and Honda show that there is apparently change of elasticity by magnetization. It appears to me quite plausible that the change observed by elongation or flexure method is a joint effect of the variation of length change and that of the modulus of elasticity. How these two effects are to be discriminated is a problem still to be solved. By flexure experiments, Honda found that there is apparent increase of Young's modulus in iron and steel, except in weak fields. In nickel Young's modulus decreases in weak fields and increases in the strong, while in cobalt, there is increase. Torsion experiments show that there is apparent increase of rigidity in iron, steel, and cobalt. Nickel shows decrease of rigidity in weak fields and considerable increase in the strong.

The sound emitted by magnetizing an iron wire by intermittent or alternate current was long known, but the actual measurement of the change of length was undertaken quite recently by Honda and Shimizu. With a given wire, the amplitude varies with the frequency; generally there are two maxima in iron and nickel as the frequency is increased. The phenomenon is evidently due to magnetostriction.

Closely allied with magnetostriction is the effect of magnetization on the permanent torsion of ferromagnetic wires; the nature of the change is well illustrated by the experiments of Wiedemann on iron wire and of mine on nickel.

No experiment has as yet been tried on the magnetostriction of ferromagnetic crystals. The axial behavior of crystals would be the most interesting subject of investigation. Probably there are a good many problems on the magnetoelastic properties, which still remain untouched and which are intimately connected with magnetostriction.

The theory really satisfying the various aspects of the phenomenon, as before remarked, is still in its infancy; no one has as yet dared to break through the barrier line of the phenomena presenting hysteresis; when once the path for attacking physical problems involving residual effect is opened, we may look forward for a complete description of the phenomena in a concise mathematical language.

NOTE.—Stevens, *Phys. Rev.*, 10, 161; 11, 95, 1900; Schreber, *Phys. Zeit.*, 2, 18, 1900; Löffler, *Diss. Zürich*, 1901; Tangl, *Drude Ann.*, 6, 34, 1901; Honda, Shimizu, a. Kusakabe, *Phys. Zeit.*, 3, 380, 1902; *Phil. Mag.*, 4, 459, 1902; *Phys. Zeit.*, 3, 381, 1902; *Phil. Mag.*, 4, 637, 1902; Honda a. Shimizu, *Phil. Mag.*, 4, 645, 1902; Arnoux, *Journ. de Phys.*, 2, 258, 1903; Grimaldi a. Arcolla, *Bollatino*, Catania, Feb., 1904; Sano, *Phys. Rev.*, 13, 158, 1902; *Phys. Zeit.*, 3, 407, 1902; Heydweiller, *Drude Ann.*, 12, 602, 1903; Koláček, *Drude Ann.*, 13, 1, 1904; 14, 177, 1904; Gana, *Drude Ann.*, 15, 634, 1904.

ON SECONDARY STANDARDS OF LIGHT.¹

BY PROFESSOR J. VIOLLE, *École Normale Supérieure, Paris.*

A practical standard of light must satisfy certain conditions of applicability, accuracy and convenience. For, as regards applicability, it must possess a definite color and size; for accuracy, an invariable relation to the fundamental standard and permanence; while for convenience it must be simple and easily operated.

Let us examine these different points successively. A unit is by definition a quantity chosen from all others of the same nature to serve as a means of comparison in terms of which we express the respective values of their magnitudes. According to this, each kind of light constituting a special category should be compared with a particular unit belonging to that category.

In considering all the various luminous sources in use, let us note that the same lamp, forced to a greater or less degree, constitutes a whole series of different luminous sources, and let us consider what complicated systems of units we are forced to face, although we consider each kind of source as a distinct individuality without troubling to sift it to its elements.

In truth the only correct way to define a source of light is to establish the intensity of each frequency of radiation with respect to that of the corresponding standard. But our eye, on which we must rely in photometry, makes the synthesis of all these radiations according to its own laws. We shall therefore take the position that a source of light is one and only one quantity, determined by the two essential properties—the color and the intensity. It follows that two sources of light of as different kind as may be desired, shall be practically and physiologically equal, if they have the same color and the same intensity. And as the judgment of our eye allows a certain latitude, we shall

1. This paper should be considered as following that presented by the author on the same subject at the International Electrical Congress at Paris in 1900. Questions have been here avoided which were treated in the preceding paper, to which the reader is requested to refer.

take advantage of this in order to secure, in practice, the greatest simplicity possible.

We have to-day photometers to measure the intensity of light with all desired exactitude when we compare two sources of light of the same color. In comparing successively different photometers, and measuring at different distances, we always obtain the same result. This is not so with two different sources of color. Notwithstanding the most ingenious devices, we have not yet succeeded in establishing a satisfactory method of color-photometry, and this is indeed not surprising. Uncertainty grows as the difference of color increases. Our eye cannot establish a sharp distinction (omitting a spectro-photometric analysis) between the smoky candle of our ancestors, and the brilliant sources of light which give us illumination to-day. Leaving aside those sources of light which have been abandoned, if we do not want to use a number of different standards, which would complicate matters considerably, the condition that the only practical standard must satisfy will be to be as close as possible in color to the sources of light commonly used.

Although this statement may appear vague, it nevertheless corresponds to the true state of affairs. To-day the red-colored flames have disappeared. Our light has become whiter, or, rather, more yellow, getting closer to the green and blue. The green will not likely prevail, if we judge by the first mantles of the Auer light mostly affected with that tint. As far as blue is concerned, our eyes are too poorly adapted to it to give it predominance in lighting. It appears, therefore, that the color of the best light not only to-day, but for the future, must be yellowish white, similar to that of a good oil lamp, or of an incandescent lamp (either the electric incandescent lamp with high enough voltage, or incandescent gas or alcohol with the usual mantles), or again, of an acetylene lamp. Although the color of all these lights is not identical, yet it does differ so much as to prevent a comparison with a common standard.

Our eyes, it is true, do not require as exact a comparison as can be detected, or an absolute identity of color. It adapts itself to circumstances, small differences being allowed, due to physiological effects. Even if the total color comparison should present some difficulty, it would be preferable to a comparison apparently more correct, when restricted to a part only of the radiations; for the parts left aside may play an important part. The use

of absorbents capable of removing certain rays is really useful only as a convenient form of spectrum analysis.

The last condition required by the practical standard is a certain magnitude with respect to the usual sources of light to be compared. It seems right that the size should be 10 or perhaps better 20 decimal candles (*bougies decimales*). Nothing, however, will be easier than to have multiples and submultiples of the desired standard.

According to the above considerations, the practical standard should be taken from the usual sources of light, or from similar sources of light suitable for that purpose. These sources are of two kinds: Incandescent solids or liquids, and flames. Amongst the first are to be mentioned platinum and carbon, and the bodies which have been substituted for them—the mantles of the rare earths. Platinum, which has furnished the fundamental unit, seems suitable for furnishing the required standard.

The remarkable instrument of Lümmer and Kurlbaum has been used with advantage at the Physico-technical Laboratory at Charlottenburg to verify the Hefner lamp. It possesses it is true very little of the Hefner tint, and presents consequently the above-mentioned inconvenience. The instrument would be found, however, very sensitive and regulable for general use.

M. Petavel, who has studied the fundamental standard with so much care, proposes as a secondary standard a platinum strip alloyed with 25 per cent of iridium, electrically heated to a temperature which he determines by a measurement of the relative intensity of two different radiations. This secondary standard, first compared with the absolute standard, might serve to calibrate the commercial standards. For the measurement of the relative intensity of two different radiations, he makes one part of the rays go through a glass plate, which absorbs the ultra-red rays, and another part through highly colored fluorspar which stops nearly all the visible rays. He then receives these two different parts on two thermo-junctions connected in opposite series with the same galvanometer. The current supplied to the strip is regulated until there is no deflection on the galvanometer. The process is simple, and deserves to be studied with care.

There is nothing new to be noted in the trials made for the purpose of utilizing as a standard the positive crater of the arc. It seems to remain just as hard to handle, while, on the contrary, the incandescent lamps become every day easier to use and are

for that reason more and more used as intermediary standards. Even if a little yellow, and not always closely enough watched, the incandescent lamps have the great advantage of being free from the variations which affect the flames caused by changes in atmospheric conditions. They also offer the advantage of operation in any position, horizontal as well as vertical, being very useful in certain cases. One can also standardize a number of them at once, and set aside a certain number as primary standards, with which comparisons can be made when required. The lamps in general use, which are operated for only a very short period of time, may be kept a good many years without any appreciable change, as Dr. Fleming has shown. He recommends, however, in order to avoid blackening of the glass, using a very large bulb of a radius greater than the average path of the carbon molecules at the pressure of the residual air. In this bulb should be mounted a filament of good quality, tested beforehand for a period of 50 hours, at a voltage slightly higher than that at which it is intended to be used.

Again, in order to reduce the continuous diminution in the intensity of light owing to the alteration in the resistance of the filament, M. Fabry has devised a lamp which operates at constant power. He employs a method of electric equilibrium very readily applied, and avoids also the accidental variations which too frequently affect such measurements. The regulation of the lamp is reduced to the measurement of the difference of potential between a part of the main circuit separated from the lamp by a small resistance, and a part of a high resistance connected between the two terminals of the lamp and conveniently arranged in such a manner that the difference of potential in question may be balanced by the e.m.f. of a standard Weston cell which has a negligible temperature coefficient.² By pressing a key, the differences of potential are offered on a galvanometer which should read zero. If a deflection is observed, the reading is brought to zero by a rheostat in the main circuit.

Many attempts have been made to replace the carbon filament in the incandescent lamp by a more advantageous substance. Thus Mr. Crawford Voelker has used carbide of titanium, in a very interesting lamp tested with great care by Mr. Holden, in the arsenal at Woolwich.

2. We should use also for the resistance a metal of no temperature coefficient, such as constantin or manganin.

The celebrated inventor of the incandescent mantle for gas, Dr. Auer, also sought to produce an incandescent electric lamp. His lamp, according to M. Gabriel, shows great constancy when closely watched and is very sensitive to slight changes of voltage. In a report presented to the German Society of Incandescence of Berlin, the chief engineer, Remané, declares that the specific consumption of the Osmium lamp is 1 watt per cp, the light resembling daylight very closely, an important property in a photometric standard. The Nernst lamp would be less advantageous in this respect, although so remarkable in many ways. According to M. Wedding, the expenditure of power in the Nernst lamp is less than that in carbon filaments, and the steadiness greater, without being complete: Troublesome variations sometimes occur (as shown by lamp No. 2 of the Wedding tests, one of the best of the twelve lamps tried). If we examine the mode of variation of the intensity of light along the lines studied by Mr. R. P. Hulse, it appears that Fabry's system would do very well for constant measurements.

We come finally to the mantles of rare earths, invented by Dr. Auer, which gave such an impetus to gas lighting, and which had previously remained unemployed notwithstanding several remarkable attempts. It does not appear that we could use them as practical standards. We will not seek our standard from among them, if we consider that mantles of the same material placed on the same burner give a very different intensity of light, that the same mantle on the same burner presents a diminution of light varying irregularly with time, and that we are still ignorant of the effect of the calorific power of the gas on the intensity of light given by the mantle. Moreover, it is to be remembered that the conclusion arrived at by the International Commission of Photometry appointed by the International Congress at Paris in 1900, was that the adoption of a secondary incandescent mantle standard for the measurement of the intensity of incandescent gas burners can not be made in the present state of the art of mantles.

Let us pass now to flames. It is not necessary to repeat here the inconveniences that are justly charged to them. On the other hand we find that they are so far outweighed by the advantages of simplicity and usefulness, that up to this date they have furnished all of the various secondary standards in use, amongst which are, in particular, to be noted the Carcel, the Vernon-

Harcourt and the Hefner. Each has its particular well-known advantages and defects, so that it is unnecessary to recount them.

Concerning the standards themselves, it may be mentioned that the Vernon-Harcourt standard of one c.p., which was presented by the author to the British Association of the Plymouth meeting in 1877, was too complicated and too difficult to handle for general use, and, not being, therefore, suitable to serve as a primary standard (to be compared as is well understood with the fundamental standard). Mr. Vernon-Harcourt has lately constructed a standard of six candles.³ A description of which was given by the "Gas Referees" in their report of Oct. 9, 1901. At the top of a hollow pillar is a reservoir in which air becomes saturated with the vapor of pentane that has first been introduced, and from this the mixture of air and vapor, syphoned from the top of the liquid, comes down by gravity to an Argand type of burner, made of soap-stone, where it burns, giving a well-defined flame. A long chimney, made of brass, placed at a certain distance above the burner, hides the top of the flame; a small mica window allows the top of the flame to be seen, and its height to be thus regulated. Around the chimney is a large tube, open at the bottom to the air. The air becomes heated in rising, and feeds the interior of the flame affording a real regeneration. In the interior, air arrives by a second mantle placed at the base of the burner. The flame is, however, surrounded by a conical screen, pierced by an opening which allows the portion beneath the chimney to be clearly seen. There is no gas nor any clearly exterior mechanism to bring the vapor from the pentane to the burner. This process shows a marked advance. It has been studied jointly with the Carcel and the Hefner by the International Commission of Gas Photometry. The conclusion of the commission, as far as concerns the relative value of the three standards, will be very interesting to learn.

It would also be desirable for this commission to study acetylene, which has been recently the object of numerous interesting papers. Prof. Nichols has measured the temperature of the flame (1900) and has determined its luminous efficiency⁴ (1901). Following the same determinations, Mr. Stewart has succeeded, by the Paschen method, in establishing the amount of energy in

3. The magnitude of this standard is very useful in practice, as noted above.

4. Proportion of the light energy to the total radiating energy.

the flame; he has recognized that the application of the formula $\lambda_m T = A$ requires that one should know, like MM. Lümmer and Pringsheim, the reflective power of the flame with respect to its absorbing power, and also, as Mr. Kurlbaum and Mr. Nichols have shown, of the selection that is manifested in the yellow region of the spectrum for the radiations of particles of carbon. I have recently obtained very similar results relative to the separation of the various radiations in the flame of acetylene, by photographing it on isochromatic plates behind screens colored in such a way as to obtain lights truly monochromatic. The flame has appeared to me to be a little whiter than Mr. Stewart indicates it. This is no doubt due to the fact that I was working with a lamp in which the flame was located in the interior of a metal box producing the effect of a chimney, which accelerates combustion and renders the flame whiter, as well as less sensitive to exterior disturbances.

The acetylene flame has the drawback of being affected by the accumulation of carbon deposited in the burner. It is, no doubt, to obviate this that the commission of the American Institute of Electrical Engineers burns a mixture of two parts of acetylene and one part of hydrogen in a current of oxygen. If we could operate with pure gases, under identical conditions, we would have a perfectly constant flame. Oxygen renders the flame blue, burning besides any free carbon, and, as the purity of the combustion is the first condition to be imposed, the difficulty is doubled by having a mixture of both hydrogen and acetylene.

Dr. Sharp prefers, with reason, to burn pure acetylene in pure oxygen. He uses for that purpose a very ingenious blowpipe in which the central tube is cooled by a water-jacket circulation while the oxygen arrives by the annular space between this central tube and the socket. For a certain proportion of the two gases the luminous intensity is a maximum, and a horizontal slit, made at a convenient height in a screen, allows a perfectly well-determined and fixed amount of light to go through. The flame thus produced is very brilliant; according to the author, "its color is perfectly correct for a secondary standard for the photometry of the arc, but is too white for the incandescent lamp, just as the Hefner is too red. This defect is in the right direction, the tendency of the average color of the different sources of light tending toward the white." One must not, however, overestimate, because bluish white is stern and tiring. The eye, doubtless, prefers a

golden tinge, rich and gay, better adapted to the normal play of our vision. In any case we owe much to Dr. Sharp, for he has realized an instrument which offers the great advantage of producing a flame completely shielded from exterior disturbances, which are so great on the ordinary flames, especially atmospheric conditions.

Another well-defined substance could be employed as a combustible. M. von Hefner Alteneck has proposed acetate of isobutyl. It is also evident that the mixture of alcohol and benzine employed by M. Blondel burns in constant proportions, and is equivalent to a single liquid. But it seems as if the acetylene which is extending every day for lighting should be preferred thereto.

It is desirable that the users of electricity and gas should agree on the choice of a practical unit, the value of which should be determined with respect to the fundamental standard, and which would serve afterwards in all photometric laboratories to control the apparatus in general use. This eminently useful understanding appears so much easier than the rivalry, which has, unfortunately, manifested itself between different countries, about the standards of light, and which does not exist between gas users and electricians. Gas people frequently use incandescent lamps as intermediary standards, while electricians, on their side, make daily use of the flame standards to control their lamps. The work of the International Commission of Photometry should then be broadened according to the indications which might be given to it by the International Electrical Congress at St. Louis.

CONDENSATION NUCLEI.

BY C. T. R. WILSON, F. R. S., *Fellow of Sidney Sussex College,
Cambridge.*

If we take the ordinary air of a room, and enclose it in a glass vessel containing some water and provided with some means of increasing or diminishing the volume at will, we are able to observe the following phenomena. If the air has been allowed to stand sufficiently long to become saturated with water vapor, any increase of volume, even if very slight, causes the formation of a fog throughout the volume of the moist air. This is easily made visible by concentrating a powerful beam of light on the contents of the vessel; or, by placing a small source of light behind the vessel, brilliant colored rings or coronas may be seen surrounding the source. If the air be made to contract again to its original volume, a second expansion like the first will again give a similar fog, but when this process has been several times repeated, the fogs become thinner, the drops being fewer and larger; we get at length a fine rain on expansion rather than a fog, the drops falling to the bottom of the vessel within a few seconds, instead of remaining in suspension for many minutes like the first-formed fog particles. When this stage has been reached, the next and all succeeding expansions produce no drops at all, no condensation resulting elsewhere than on the walls of the vessel. If ordinary air be now admitted into the vessel, drops will again be seen on expansion, unless the air introduced has entered through a tightly pressed plug of cotton-wool, or has been otherwise filtered, in which case no drops are seen.

The phenomena are readily explained if we suppose that water cannot under ordinary circumstances condense in the form of drops unless suitable nuclei are present to serve as starting points for the drops. These nuclei are present in very varying numbers in ordinary atmospheric air, from which they may be removed by filtering, or by repeatedly forming a cloud by expansion, and allowing the drops to fall to the bottom of the vessel. Both the facts and

the explanation have been long known. The particles which serve as the nuclei of the drops formed, when ordinary atmospheric air is allowed to expand slightly, are conveniently called "dust" particles; they are generally too small to be themselves visible, and it would be difficult to find a means of determining whether they consist of solid particles or of minute drops of liquid. The number of these dust particles per c.c. of air in different localities and under different weather conditions has been investigated by Aitken, and by others, with the aid of his ingenious dust-counting apparatus.

It is not difficult to understand why nuclei should be necessary for the condensation of water in the form of drops. Lord Kelvin proved that the pressure of aqueous vapor necessary for equilibrium over a convex or concave surface of water differed from that over a flat surface, being less over a concave and greater over a convex surface. He shows how we may calculate the difference. A very small drop of pure water will, if we assume the surface tension to remain the same for very small drops as for large ones, evaporate even when surrounded by vapor many times more dense than that in equilibrium at the same temperature over a flat surface. Thus unless the initial stages of the growth of the drops can be, as it were, omitted, owing to the presence of not too minute nuclei, a high degree of supersaturation may exist without any condensation in the form of rain or cloud resulting. Lord Kelvin showed that to alter the equilibrium vapor-pressure by one part in a thousand, the radius of curvature of a spherical drop must amount to about 10^{-4} cm. Thus very minute nuclei will enable a cloud to be formed with a very slight degree of supersaturation, in other words, as a result of a very slight expansion of the air if this has been initially saturated with water vapor.

Lord Kelvin refrained from extending his calculations to curvatures of greater amount, as the surface tension cannot remain independent of the radius much beyond that limit. It is convenient, however, to extend the calculations to greater curvatures; for although the results obtained cannot be considered as quantitatively correct, they enable us to form a picture of the mode of action of nuclei of different kinds. Let us imagine an arrangement equivalent to that considered by Lord Kelvin¹; but since we are

1. *Proc. Roy. Soc. Edin.* VII, p. 63. 1870.

here concerned with convex surfaces, let the capillary tube be joined as a side tube to the lower part of a tall vessel of water. The capillary must be supposed to have walls of such a nature as not to be wetted by water, and let us suppose the open end of it to be bent round, so that it points vertically upwards, and that the height of the vertical portion can be adjusted to bring the meniscus to the open end of the tube. Let the whole apparatus be contained in a closed vessel containing only water vapor.

We have then the convex water-air meniscus depressed below the level of the flat surface in the large vessel to a depth h , such that $gwh = 2T/r$, where g is the acceleration due to gravity, w the density of the liquid* ($w = 1$ in the present case), T is the surface tension and r the radius of curvature. Thus the pressure of the vapor in contact with the meniscus must be greater than that over the flat surface by that due to the weight of a column of water vapor of height h , the pressure at the top of the column being that required for equilibrium over a flat surface at the given temperature. This increased pressure must, moreover, be the pressure necessary for equilibrium over the curved surface, distillation from the one surface to the other would otherwise take place resulting in a continuous circulation. To find this pressure p_2 , p_1 being that at the flat surface, we have $dp = g \rho dh$,

$$h = \frac{1}{g} \int \frac{dp}{\rho}$$

ρ being the density of the steam. If we assume Boyle's law to be obeyed, this gives

$$h = \frac{Rt}{g} \log_e \frac{p_2}{p_1} = \frac{Rt}{g} \log_e \frac{\rho_2}{\rho_1}$$

R being the constant in the equation $pe = Rt$, t being the absolute temperature, ρ_1 , ρ_2 the density of the vapor at the two surfaces respectively. But $h = 2T/rg$, thus

$$\log_e \frac{p_2}{p_1} = \log_e \frac{\rho_2}{\rho_1} = \frac{1}{Rt} \cdot \frac{2T}{r}$$

We have thus the means of calculating the pressure, or the density, which water vapor must have, in order that it may be in equilibrium in contact with a drop of any size. The equilibrium is obviously unstable, a drop if too big for equilibrium will grow,

* The weight of a column of the vapor is neglected in comparison with that of a column of the liquid of the same height.

so long as the supersaturated condition is maintained, if too small it will evaporate completely. The possession of a charge of electricity by the drop, or the existence of a dissolved substance within it, will cause the drop to be stable, if its size be less than a certain limit, depending on the magnitude of the charge, or the quantity of dissolved substance. Let us consider the case of electrification. We may imagine the water surface in one limb of a U-tube, in an arrangement like that described above, to be uniformly charged with electricity, by holding a very short distance above it a parallel conducting surface maintained at a different potential. It is immaterial whether the water surface be flat or curved; a tension of $2 \pi \sigma^2$ dynes per square cm will be exerted on the end of the column, σ being the charge per sq. cm. This will raise the electrified surface, above the level which it would have occupied in the absence of the charge, through a distance $2 \pi \sigma^2/g$ and there will be a corresponding diminution in the saturation vapor-pressure. The vapor pressure necessary for equilibrium over a charged drop is now given by the equation

$$\begin{aligned} \log_e \frac{p_2}{p_1} &= \frac{1}{R t} \left(\frac{2T}{r} - 2 \pi \sigma^2 \right) \\ &= \frac{1}{R t} \left(\frac{2T}{r} - \frac{e^2}{8 \pi r^4} \right) \end{aligned}$$

where p_1 is the saturation vapor-pressure over a flat uncharged surface, p_2 that necessary for equilibrium at the same temperature in presence of the drops, and e is the charge on each drop. In an atmosphere saturated with respect to a flat uncharged surface, a drop carrying a charge e , would be in stable equilibrium if its radius were such that the two terms on the right-hand side of the above equation were equal, i. e., when $r^3 = e^2/16 \pi T$. If the density of the vapor were increased, the drop would become larger, the equilibrium remaining stable until the vapor-pressure reached the maximum value corresponding to the above equation. To find this we have on differentiating

$$\frac{1}{\rho} \frac{dp}{dr} = \frac{1}{R t} \left(-\frac{2T}{r^2} + \frac{1}{2} \frac{e^2}{\pi r^5} \right)$$

The maximum vapor-pressure in contact with the drops occurs when $r^3 = e^2/4 \pi T$, and has the value given by

$$\log \frac{p_2}{p_1} = \frac{3T}{2 R t r}$$

If the pressure of the vapor be increased beyond this limit, the unstable condition is reached, and the drop increases in size so long as the supply of vapor is unlimited. In most cases the final size of the drops would be determined by the amount of vapor initially present, and the number of drops among which the water is distributed; unless they are very numerous, and, therefore, very small when full grown, they will grow until the vapor is not sensibly supersaturated; it will only be in very rare cases that the final size of the drops is so small that equilibrium will be reached while the vapor is at all supersaturated.

It is easily seen that the behavior of drops containing dissolved substances will be quite similar; if we start with very small drops, there is for a given size of drops a certain vapor-pressure corresponding to equilibrium, if we increase the density of the vapor the drop grows, the equilibrium remaining stable, until a certain size is reached, after which the drops suddenly grow to their full size. The theory of condensation on ions or other nuclei has been treated by J. J. Thomson² and by Langevin and Bloch.³

LIMITING SUPERSATURATION IN DUST-FREE GASES.⁴

When air saturated with water vapor has been freed from dust particles, no drops are formed on expansion, provided that a certain critical degree of supersaturation has not been exceeded. To produce the supersaturation necessary for condensation in the form of drops in dust-free air, the air must be allowed to expand suddenly, till the final volume is 1.25 times the initial volume. The condensation is rainlike in form, and the number of drops remains small although the expansion considerably exceeds this lower limit. Expansions exceeding a second limit, $v_2/v_1=1.38$ give fogs, which increase rapidly in density, i. e., in the number of the drops, as the expansion is increased beyond this limit. In such experiments it is of course necessary that the apparatus used should be such that a very rapid change of volume can be brought about, and that the ratio of the final to the initial volume is known with certainty. Some years ago I introduced a method which has proved suitable for the purpose. When this method is

2. J. J. Thomson, "Conduction of Electricity through Gases," p. 149.

3. Bloch, "Recherches sur la conductibilité électrique de l'air produite par le phosphore et sur les gaz récemment préparés" (Paris, 1904).

4. C. T. R. Wilson, *Phil. Trans.* 189, p. 265, 1897.

used, it would appear from the consistency of the results obtained with cloud-chambers varying in capacity from 15 to 1500 c.c., that the expansion is adiabatic and is completed before any appreciable quantity of water has had time to separate out. From the ratio of the final to the initial volume, knowing the initial temperature, we can deduce the temperature at the moment when the expansion was completed from the equation for the cooling of a gas by adiabatic expansion,

$$\frac{\theta_2}{\theta_1} = \left(\frac{v_1}{v_2} \right)^{\gamma-1}$$

γ may be taken as not differing sensibly from its value for the dry gas. Knowing the final temperature we have the data from which we can obtain the density of the vapor which would be required for saturation at the moment of completion of the expansion, and we know the actual density at that moment from the initial temperature and the ratio of the final to the initial volume. Thus the supersaturation, measured by the ratio of the actual density of the vapor at the instant when the expansion is completed, to the density of the saturated vapor at the temperature which the supersaturated gas then possesses, can be calculated.

The supersaturation required for the rainlike condensation is found in this way to be approximately fourfold, that required for the cloudlike condensation being nearly eightfold. There are these two classes of nuclei always present in moist dust-free air, and always being produced, for, however often the process of condensing water on the nuclei and allowing the drops to settle is repeated, the number of drops formed in subsequent expansions is undiminished. The nuclei which give rise to the rainlike condensation and which are at any moment present in quite small numbers are, as we shall see, ions continually being produced in the gas. They can be removed by an electric field. The cloudlike condensation occurring with large expansions is entirely unaffected by an electric field; it is independent also of the nature of the gas. If we calculate how large a drop of water would require to be in order that it should just be able to grow in vapor of eightfold supersaturation, we obtain the very small value 6.4×10^{-8} cm for the radius of such drops. Thus drops not large in comparison with molecular dimensions might be expected to grow into visible drops in an atmosphere supersaturated to this extent.

THE IONS AS CONDENSATION NUCLEI.⁵

If we expose the cloud chamber of an expansion apparatus to the action of Röntgen rays, the air having been previously freed from dust, just the same expansion is required as in the absence of the rays to produce drops, but now we get comparatively dense fogs in place of the rainlike condensation. The cloudlike condensation obtained with expansions exceeding the second limit is not sensibly affected. Thus, when X-rays pass through moist air, they produce nuclei of exactly the same efficiency in promoting condensation, as those which are always being produced in small numbers, and to which the rainlike condensation is due. The conducting power imparted to air by the action of X-rays being explained as due to the setting free of ions in the gas, it was natural to identify the nuclei with the ions.

This view was verified by studying the action of an electric field on the nuclei produced by X-rays. Between two parallel plates, which formed the top and bottom of the cloud chamber of an expansion apparatus, a difference of potential of some hundred volts could be applied. With the electric field acting the number of drops produced on expansion in air exposed to the rays was exceedingly small in comparison with the number seen in the absence of the field. The nuclei carry a charge of electricity, and are driven by the electric field against the plates immediately after being set free. The direct proof that the few nuclei, which are always present and which give rise to the rainlike condensation, are also ions has been more difficult to carry out. Attempts made with small apparatus led to negative results, the number of drops being inconveniently small whether the field was applied or not. Recent experiments on a large scale, however, showed in a striking way the removal of these nuclei by the electric field. The subject has been further cleared up by proof by purely electrical measurements that the air in a closed vessel is continually being ionised.⁶

Air ionised by any of the various types of Becquerel rays, or containing ions from a zinc plate exposed to weak ultra-violet light, behaves, on expansion, like air exposed to X-rays; fogs being produced in air initially saturated if the lower expansion limit $v_2/v_1 = 1.25$ be exceeded. The action of an electric field in re-

5. C. T. R. Wilson, *Phil. Trans.* 192, p. 403, 1899.

6. Geitel, *Physikalische Zeitschrift*, 2, p. 116, 1900; C. T. R. Wilson, *Proc. Roy. Soc.*, 68, p. 152.

moving the nuclei is the same in air ionised by Becquerel rays, as in air ionised by X-rays. The ions produced by the discharge from a point are similar in their action; but there is here a tendency, due probably to the products of chemical combinations brought about by the luminous discharge, for the nuclei to grow, or for larger uncharged nuclei to be formed, so that a much smaller degree of supersaturation may be required to produce a cloud. The ions produced by these various methods are also identical in the velocity with which they move through air under a given potential gradient. The degree of supersaturation required to make water condense on the ions is independent of the gas.

If we make use of the equation which has been given above, connecting the maximum supersaturation with the charge of the drop, we obtain the result $e = 6 \times 10^{-10}$ electrostatic units for a fourfold supersaturation. To obtain this number we have of course extended to drops of almost molecular smallness, $r = 7 \times 10^{-6}$ cm, an equation which could only be used with confidence when the radius was at least a thousand times as great. It is, therefore, somewhat remarkable that the value obtained approximates fairly closely to the values found by J. J. Thomson and by H. A. Wilson for the ionic charge. The action of the ions as condensation nuclei is not, however, completely explained, for our formula would make efficiency of the electrification in helping condensation independent of the sign of the charge. Now the negative ions are found to require a less degree of supersaturation to make water form visible drops upon them than do the positive.

DIFFERENCE BETWEEN POSITIVE AND NEGATIVE IONS.*

To study this question, we may use an expansion apparatus provided with a cloud chamber, in which the air under examination is contained between two horizontal plates kept at slightly different potentials. A thin stratum of the air immediately over the lower plate is exposed to the action of X-rays. A series of observations are then made in which the rays are cut off at a definite interval of time before the expansion is made, the interval being such that all the downward moving ions have had time to reach the lower plate, while only a small proportion of the upward moving ones have reached the much more distant upper plate before the

* 7. C. T. R. Wilson, *Phil. Trans.* 193, p. 239.

expansion takes place. Thus, at the moment of expansion, we will have practically ions of only one kind present, those namely which are moving toward the upper plate.

In this way it has been found that in order that water may condense upon them to form visible drops, the negative ions require an expansion $v_2/v_1=1.25$, the positive an expansion 1.31, the corresponding supersaturations being fourfold and sixfold respectively.

When ions of both kinds are present in approximately equal numbers, it is often possible to observe a difference in the density of the resulting cloud according as the expansion is below or above the limit corresponding to the degree of supersaturation necessary for the condensation of the positive ions. The increase in density was first described by J. J. Thomson, and it was suggested by him that it might be due to a difference between the positive and negative ions in their efficiency as condensation nuclei; he pointed out that such a difference, if established, would have important bearings on the subject of atmospheric electricity. For an electrical field might be expected to result in ionised air if such a degree of supersaturation was reached that condensation took place on ions of one kind only, these loaded ions being then carried down by gravity. That the drops produced under these conditions are actually negatively charged, as was to be expected from the greater efficiency of the negative ion as a nucleus, was proved by H. A. Wilson, by observing the movement of the drops in a strong electric field applied after their formation by expansion.

CHARGE CARRIED BY THE IONS.

The most important use which has been made of the fact that ions act as nuclei for the condensation of water vapor has been in the determination of the quantity of electricity carried by each ion. Two entirely different methods have been employed, both requiring the use of the expansion apparatus. In the first, that of J. J. Thomson⁸, a measurement of the leakage of electricity through the air of the cloud chamber allows $n \cdot e$, the product of the number of ions and the ionic charge, to be measured; n , the number of the ions is given by the number of the drops. The number has been obtained, not by direct counting, but from a knowledge of the quantity of water condensed, and the size of the drops

8. J. J. Thomson, *Phil. Mag.* v. 46, p. 528, 1898; *Phil. Mag.* v. 48, p. 547, 1899; *Conduction of Electricity through Gases*, p. 121.

as obtained from their rate of fall. The second method (used by H. A. Wilson⁹) in its simplest form reduces itself to a determination of the strength of the electric field necessary to maintain in suspension the drops condensed upon the ions. We then have $F e$, the product of the strength of the field and the charge on the drop, equal to its weight. The size of the drops, and hence their weight, is again deduced from the rate of fall in the absence of the field.

OTHER PROPERTIES OF THE IONS.

There is no room for doubt that the nuclei produced by X-rays and similar agents, and requiring a fourfold or sixfold supersaturation to make water condense on them, are negatively or positively charged ions. We know by other methods of studying them a great deal about the properties of ions, their velocity in an electric field, their diffusion constants and rates of recombination under different conditions. Their behavior when studied by condensation has been entirely in agreement with the results obtained by other methods; for example, the rapidity with which their number diminishes after the source of ionisation has been cut off.

NUCLEI SIMILAR IN EFFICIENCY TO THE IONS, BUT NOT REMOVABLE BY AN ELECTRICAL FIELD.

Moist air exposed to weak ultra-violet light is found to contain a plentiful supply of nuclei, which require a degree of supersaturation approximately the same as do the ions, in order that a cloud may form upon them. Yet even very strong electric fields appear to be without effect in reducing the number of drops formed on expansion. Certain metals also produce in the air in contact with them similar nuclei, the clouds in this case, however, not generally attaining any considerable density, unless the expansion is great enough to cause condensation on positive ions. It is possible that we have in both these cases ions produced as a result of the expansion, there being, therefore, no time for the ions to be removed by the field before the cloud is formed.

NUCLEI MORE EFFECTIVE IN PROMOTING CONDENSATION THAN THE IONS PRODUCED BY X-RAYS.

If we expose moist air to ultra-violet of moderate intensity, the result is not so simple as when the intensity is very small. Nu-

⁹ H. A. Wilson, *Phil. Mag.* [6], p. 576, 1903.

clei are produced, which appear to grow under the action of the light, the expansion required to produce a cloud becoming less than that required by the negative ions, and becoming less and less the stronger the light and the longer the exposure. For a given intensity of the light, there appears to be a maximum size beyond which the nuclei cease to grow. A very moderate intensity is sufficient to produce nuclei which grow till the slightest expansion will form a cloud, and the growth is very rapid so that the earlier stages are difficult to follow. With very intense ultra-violet light, the growth continues till the nuclei become visible in suitable illumination, and we get a cloud without expansion, even in unsaturated air. There can be little doubt that the growth of these nuclei into visible drops is to be attributed to the formation of some substance in solution within them. Vincent has recently studied these visible nuclei and found some of the particles to be positively, some negatively charged, and others neutral; but he finds the evidence to be in favor of the view that the charges are, as it were, accidental, being simply due to ions which have come in contact with them. Lenard had previously shown the ionisation of the air by these rays.

The very small nuclei, i. e., those which require large expansions to make drops form upon them, diffuse rapidly to the sides of the vessel, so that a fog is not formed if the radiation be cut off even one minute before the expansion is made; the nuclei which are large enough to be visible may persist for hours on account of their very slow diffusion.

Other nuclei, which like those produced by ultra-violet light, vary in size with varying conditions, are those produced by heating a wire, studied some time ago by Aitken and recently by Owen. The latter has shown that the lower the temperature at which they have been given off by the wire, the greater is the expansion required to catch them. They can be detected when the wire has been raised to a temperature of less than 150° C. in air. The nuclei produced by the slow oxidation of phosphorus, like those formed by the action of strong ultra-violet light, form visible clouds in air which is not supersaturated. These clouds have been studied by Barus and others. As in the cases just considered, the production of the nuclei is associated with the acquisition of conducting power by the gas. There has been a considerable amount of controversy as to the nature of the conduction of elec-

tricity in air which has passed over phosphorus. The experiments of Bloch¹⁰ have, however, proved from the nature of the curve obtained for the relation between current and potential difference, that we have here a true case of ionisation. His measurements of the velocity of the ions showed that they have a very small mobility as compared with the ions due to X-rays. His experiments leave little room for doubt that these slow-moving ions are identical with the nuclei. The mobility is about a thousand times smaller than that of the ions formed by X-rays.

Certain experiments of Harms¹¹, and of Elster and Geitel¹², appear to show that by the oxidation of phosphorus, free ions are produced, in addition to the visible cloud particles. These we should expect to be rapidly removed by diffusion and recombination, and, after passing through any considerable length of tubing, we should expect only the loaded ions to persist. The absence of unloaded ions in Bloch's experiments is perhaps to be explained in this way.

The nuclei found in freshly prepared gases, and studied especially by Townsend, resemble in many ways those resulting from the oxidation of phosphorus. Like them, they form clouds without supersaturation, and they carry a charge of electricity. In some cases at least, as was shown by Townsend's experiments, the charge on each nucleus is the ionic charge. Bloch has studied the mobility of these ions, and in agreement with Townsend has found it to be of the same order as that of the phosphorus ions.

By the splashing of water or aqueous solutions, or the bubbling of air through water or solutions, nuclei are produced requiring only a slight expansion in order that water may condense upon them. These nuclei have lately been studied by Barus. He finds that the nuclei produced from salt solutions are much more persistent than those arising from distilled water. It is most natural to regard these nuclei, as does Barus¹³, as small drops which have evaporated till the strength of the solution is such, that the effect of the dissolved substance on the vapor-pressure counterbalances that of the surface tension. The splashing or bubbling process also imparts temporary conducting power to the gas. According

10. *Bloch, loc. cit.*

11. *Harms. Phys. Zeit.* 1st May, 1903.

12. *Elster and Geitel, Phys. Zeit.* 15th May, 1903

13. *Barus.* "The Structure of the Nucleus."

to Kaehler¹⁴, with pure distilled water the conduction is practically unipolar, and due to the presence of negative ions having a mobility equal to that of the ions produced by X-rays; with salt water positive ions of very small mobility are produced in addition.

In the products of combustion from flames, we find again ions of small mobility, and no appreciable degree of supersaturation is required to produce a cloud.

As Bloch points out, there are apparently two classes of ions. We have first ions like those produced by X-rays and similar agents, which have a definite velocity in an electric field of given strength, and require a definite degree of supersaturation, fourfold or sixfold according to the sign of the charge, in order that water may condense upon them. The second class consists of ions of variable mobility, about one-thousand part of that of the ions of the first class, and they have the power of condensing water to form visible drops without supersaturation. Ions with intermediate properties are rarely, if ever, met with. Bloch points out that we should expect an important difference between the two classes with respect to the result of recombination of positive and negative ions. In the first class the nucleus owes its existence to the charge; if two oppositely charged ions (which we may regard as minute charged drops) combine, we should expect the resultant uncharged nucleus to evaporate at once. On the other hand, the persistence of the ions of the second class cannot be due to the charge alone, and neutralisation of the charge will not result in evaporation of the nucleus. From recombination of these ions persistent uncharged nuclei will result. The facts are found to be in complete accord with these considerations.

If we produce a cloud in dust-free air by an expansion exceeding 1.25 after exposure to X-rays, or exceeding 1.38 in the absence of ionising agents, the drops formed, if made to evaporate by compression, appear to leave behind nuclei requiring only slight expansion to make water condense on them. J. J. Thomson has pointed out that there may be a certain size for which even uncharged drops of pure water may be stable in an unsaturated atmosphere. For, according to the experiments of Reinold and Rucker, the surface tension of thin films has a minimum for a certain thickness. There may, therefore, be a certain size (somewhat

14. Kaehler, *Ann. der Phys.* XII, p. 1119, 1903.

smaller than that corresponding to minimum surface tension) for which the potential energy of a drop due to surface tension has a minimum value. Such a drop would be in equilibrium in vapor saturated with respect to a flat surface.

Bloch, following Langevin, works out, in the paper already referred to, the theory of condensation of water vapor on ions. He shows that we might expect drops of about $10 \mu\mu$ in diameter to be stable, on account of the variation in surface tension in that region, but we should not expect to meet with drops of which the diameter was comprised between that limit and a very low value, the equilibrium of such particles being unstable. The behavior of other substances than water would probably be similar. In this way Bloch explains the fact that we do not meet with ions of mobility intermediate between about 1 cm and $1/300$ cm per second for a field of 1 volt per cm.

There are then three principal classes of nuclei: (1) The ions proper, requiring a fourfold or sixfold supersaturation to cause water to condense on them, and having a mobility exceeding 1 cm per second in a field of 1 volt per cm; (2) loaded ions requiring little or no supersaturation to make water condense on them, and having a mobility generally less than a thousandth part of that of the ions proper; (3) uncharged nuclei, resembling the second class in requiring little or no supersaturation in order that visible drops may form upon them.

CONCERNING NATURAL RADIOACTIVITY OF THE ATMOSPHERE AND THE EARTH.

BY J. ELSTER AND H. GEITEL.

The discovery of radioactivity by H. Becquerel, followed by the magnificent work of M. and Mme. Currie, has proved itself to be a great step forward in stimulating new associations of ideas and in enlightening those engaged in many different lines of investigation and thought. The physics of the earth and especially the theories concerning atmospheric electricity also shared in this scientific impulse. The well known property of the atmosphere, definitely established by Coulomb, of slowly discharging insulated electrically charged bodies, has thereby received a new significance, just at the time when it was needed for our further knowledge of atmospheric electricity. If nature had not offered us in uranium and thorium compounds, materials, whose peculiar radiations, if investigated at all, could not have escaped observation, an incomparably longer road might have had to be traveled to lead to the discovery of radioactivity in connection with atmospheric electricity. This laborious road, probably blocked by manifold errors, has not been necessitated, and meteorology and geophysics can gratefully take the results now offered on the part of physics and chemistry. The following exposition gives the radioactive properties of the atmosphere and the earth which have been found to date,— and invites further investigations of the results under consideration.

Besides the three kinds of radiation, by means of which radioactive bodies give up a part of their energy, namely the α rays, the β -rays and the γ -rays, thorium, radium and actinium (which is still hypothetical) show special effects, by means of which they, in a still higher degree than by radiation, can exert their influence in places where they are not even present, by sending out so-called radioactive *emanations*. The emanation is comparable to a gas, which develops in a small constant amount per second from the unit of weight of the radioactive substance, spreads by means of diffusion through the air and other gases, penetrates capillary canals, and

dissolves in proportion to a definite absorptive coefficient in water from which it may be again expelled by boiling, or by bubbling gases through it.

The emanation is in itself radioactive, that is to say, it causes gases with which it is mixed to become conductors of electricity; it excites phosphorescent bodies; it blackens photographic plates; and it imparts the same properties to all bodies with which it comes in contact. But the activity peculiar to this emanation is not constant in intensity.

According as it comes from radium, thorium or actinium, it disappears in time in accordance with an exponential law characteristic of its origin, and likewise the induced activity, exerted by it upon neutral bodies, dies out in a manner determined by its origin, but quite different from the one just mentioned. The intensity of the latter may be increased in an extraordinary manner by keeping the body, to which an induced activity is to be imparted, charged negatively during its contact with the active gas. Let it suffice to call to mind these facts so well known through the works of M. and Mme. Curie, and Rutherford.

After Wilson¹ and the writers² had almost simultaneously reached the same conclusion, though by different ways — Wilson by the study of the condensation of water vapour on electric nuclei, and the writers proceeding from the dissipation of electricity into the air — namely that the atmosphere has a real conductivity, that is a power of conduction depending upon the presence of free electric ions, the following investigations³ unveiled a far-reaching analogy between the electric properties of natural air and of air mixed with emanation from radioactive substances.

The difference lay essentially in the intensity, not in the quality of the effect. The attempt to prove directly the presence of radioactive emanation in the air by means of induced activity, therefore, did not appear hopeless. It was successful without any difficulty; neutral bodies may be made fairly radioactive, without the presence of radium, thorium or actinium, simply by exposing them to the contact of the open air, being charged negatively to a potential of several thousand volts.⁴

1. C. T. R. Wilson, Cambridge Philosophical Soc., 26 Nov. 1900; *Nature*, 63, p. 105, 1900.

2. *Phys. Zeit.*, 2, p. 116, 24 Nov. 1900.

3. *Phys. Zeit.*, 2, p. 560, 1901.

4. *Phys. Zeit.*, 3, p. 76, 1901; 3, p. 305, 1902. Rutherford and Allen, *Phys. Zeit.*, 3, p. 225, 1902. Allen, *Phil. Mag.*, 7, p. 140, 1904.

But what is the source of the emanation contained in the atmosphere which according to previous experience was always due to radioactive elements? Is the air itself radioactive, and does it develop emanation from itself, or does it receive it from the earth or even possibly from universal space?

The first question is easily answered; since emanation in time loses its activity it should gradually disappear in hermetically sealed spaces if the air itself does not produce it. This test applied to several cubic meters of air, enclosed in an iron vessel, confirmed this expectation.⁵ The air does not contain any permanent radioactive constituent.

Several facts which had been found in the course of these investigations were of assistance in determining between the possible terrestrial or cosmic origin of the emanation. The electric conductivity of air proved to be considerably greater when the air had been in the closest possible contact with the earth, as for instance in cellars or caves, and especially in air which had been directly sucked up from the capillary pores and fissures in the earth.⁶

An easy test, in which negatively charged metal wires were introduced into samples of air of this kind, showed that it is far richer in emanation than the open air.⁷ So the source of the radioactive properties of the latter was found to be in the earth. Emanation is uniformly developed in it, exudes from the pores of the surface of the earth, and by means of diffusion it penetrates the atmosphere.

How then does the material of the earth get this property of generating emanation, when, in the different places where these tests have been successfully carried on⁸ there is scarcely a trace of radium, thorium or actinium chemically to be detected? One might suggest, and different physicists have expressed the idea, that radioactivity is by no means confined to a few elements but that it is a common property of all matter, and manifests itself in different substances only in different degrees of intensity. If this hypothesis is true, the radioactivity of air taken from the ground needs not to be due to the presence in the earth of authentically active

5. *Phys. Zeit.*, 3, p. 574, 1902.

6. *Ibid.*

7. *Phys. Zeit.*, 3, p. 76, 1901.

8. H. Ebert and P. Ewers, *Phys. Zeit.*, 4, p. 162, 1903; F. Himstedt, *Berichte der Naturforschenden Gesellschaft in Freiburg*, i. Br., 13, p. 101, 1903; *Ann. der Phys.*, 12, p. 107, 1903; R. Börnstein, *Verhandl. der Deutschen Physikal. Gesellschaft*, 5, No. 22, p. 404, 1903.

elements. But apart from every hypothetical assumption, it seemed rational to seek in the earth for constituents, which might prove as properly radioactive. A direct examination of samples of different earths actually showed that they are all in general slightly radioactive. This quality is comparatively strongly pronounced in the clayey products of erosion of rocks, especially of those of eruptive origin, but it is wanting in pure quartz, in chalk, and in the mould formed from organic substances. Similarly, the air which is drained from this clay soil contains substantially more emanation than the air from chalk or sand. Also carbonic acid gas, which has risen from great depths in places of extinct volcanic action, has proven generally to contain emanation.⁹

With the extremely small amount of activity of the earth just mentioned, the chemical isolation of the active principle is a rather hopeless task. Notwithstanding we succeeded in showing that its chemical reactions are very much like those of radium, and point to the view that the activity may be confined to a peculiar substance.

In a most valuable manner these investigations have been completed by Sella and Pochettino,¹⁰ J. J. Thomson,¹¹ and Himstedt¹² who have found the same ever-present emanation of the earth in the water of springs, in which it dissolves according to its general properties. Especially important was the fact discovered by Himstedt.¹³ that, above all others, those waters which rise from great depths, as for example the hot springs, carry with them greater amounts of emanation, similar to the previously mentioned exhalations of natural carbonic acid gas.

The writers were likewise fortunate in finding in the mud given off by a hot spring at Battaglia in Northern Italy (the Fango) a radioactivity which by far exceeded the highest that had been observed in similar substances.¹⁴ The chemical concentration (not the isolation) of the active principle in this case was successful in so far as photographic impressions could be taken, through aluminum foil.¹⁵ The existence of an independently radioactive

9. *Phys. Zeit.*, 5, p. 11, 1904.

10. Sella and Pochettino, *Rendiconti Reale Acc. dei Lincei*, Ser. 5, vol. 11, p. 527, 1902.

11. J. J. Thomson, *Phil. Mag.*, 5, p. 591, 1902.

12. F. Himstedt, *Phys. Zeit.*, 4, p. 482, 1903.

13. F. Himstedt, *Berichte der Naturfor. Gesellsch. zu Freiburg*: Br. 14, p. 181, 1903.

14. Report of the British Association, p. 537, 1903; *Phys. Zeit.*, 5, p. 14, 1904.

15. *Phys. Zeit.*, 5, 1904 (im Druck).

substance in the material was thereby established beyond a doubt. In this connection we mention the discovery of radioactive sediments in the hot springs at Bath¹⁶ in England and at Baden-Baden¹⁷ in Germany. The assumption is probably warranted that, generally speaking, all hot springs carry in themselves suspended radioactive substances and, therefore, are charged more or less with their emanation.¹⁸ Oil wells, according to Himstedt,¹⁹ also contain this emanation. The importance of these still incipient investigations cannot yet be fully realized.

According to this there can be no doubt of the distribution of radioactive substances from the surface of the earth down even to great depths. And the question is of the greatest importance whether they be elements already known from pitchblende and thorium minerals, or new ones not yet chemically isolated, which betray their presence in this radioactivity surrounding us on all sides.

As previously mentioned, the means offered by chemistry for the separation of the substances will hardly suffice for the isolation of the radioactive element from ordinary earth. The quantity of material needed for this purpose would reach the immeasurable, as in the separation of radium alone from pitchblende, which exceeds the clay in activity more than 4000 times, the limits of possibility were reached. Only the mud of the hot springs, in which nature has provided a greater amount of the active principle, offers any prospect of success to the chemist, provided sufficient quantities of it could be procured. At present the problem must be decided by indirect physical means, and here the characterization of the radioactive elements by the character of the emanation developed by them and the rate of decay of the induced activity, serves in good stead. Experiment proves that the induced activity brought about by the emanation from the ground and from the open air (at least in Germany) acts very similarly to that derived from radium,²⁰ and that the activity induced by the emanation driven off from the water of springs obeys the same law.²¹ The activity induced by the mud from the hot springs of

16. R. T. Strutt, *Nature*, 69, p. 230, 1904.

17. *Phys. Zeit.*, 5, 1904.

18. P. Curie and A. Laborde, *Comptes Rendus*, 138, p. 1150, 1904.

19. F. Himstedt, *Berichte der Naturf. Gesellschaft zu Freiburg*: Br. 14, p. 183, 1903.

20. *Phys. Zeit.*, 5, p. 18, 1904.

21. E. P. Adams, *Phil. Mag.*, 6, p. 563, 1903; H. A. Bumstead and L. P. Wheeler, *Am. Jour. Sci.*, 17, p. 97, 1904.

Baden, on the contrary, is of quite another nature, and is not identical with either that of radium, thorium, or actinium.²² Whether this peculiarity is due to the presence of several of both these elements at the same time, or to a new one, which is still unknown, cannot yet be decided, as there is only a very small quantity of the raw material at hand. A systematic investigation for traces of radioactivity in different sorts of minerals and earths, especially in the deposits of hot springs,²³ wherever such are found, promises to throw light on some problems in chemistry, geology, and perhaps on the therapeutic problem concerning hot springs.

But the radioactivity not only of the earth but also of the air, which beyond doubt originates from the former, deserves further investigation. Many particulars have been learned from incidental observations, but measurements in extremely different climates, upon oceanic islands, and in the interior of great continents are still entirely wanting. Probably in the radioactivity of the air lies the essential source of the ions contained in it; according to Ebert²⁴ the fundamental phenomena of atmospheric electricity, the difference in potential between the atmosphere and the body of the earth, is but a consequence of the different ionic concentration in the open air and in the air of the ground. All these phenomena suggest questions of great importance and invite further investigation.

May this short sketch do its share to direct a part of the deep interest now taken in radioactive processes upon this related province so easily approached, the radioactivity of the atmosphere and of the earth.

22. *Phys. Zeit.*, 5, 1904.

23. *Phys. Zeit.*, 4, p. 522, 1903; n. 5, p. 11, 1904; W. Saake, *Phys. Zeit.*, 4, p. 626, 1903; G. C. Simpson, *Proc. Royal Soc.*, 73, p. 209, 1904.

24. H. Ebert, *Phys. Zeit.*, 5, p. 135, 1904.

THE ELECTRICAL CONDUCTIVITY OF GASES.

BY PROF. PERCIVAL LEWIS, *University of California.*

Gases are usually good insulators, but under certain conditions they transmit electricity with more or less facility. The conductivity of a gas under large electric stresses reaches a maximum at a low pressure, and then decreases with further reduction of pressure. The lowest attainable vacua will not transmit electricity in appreciable quantities, either silently or disruptively. It seems, therefore, that electricity can pass from one body to another only when associated with matter.

A fundamental problem in the study of the relations between matter and electricity is to form some conception of the mode of conductivity in gases which will be consistent with known phenomena and lead to further discoveries. The theory of electrolytic conduction in solutions is simple, consistent and fruitful, and attempts have been made to extend it to gases. The object of this paper is to show how it has been found necessary to modify and extend this theory before it can be consistently applied to the more complex processes of conduction through gases and vapors.

When the utmost care is taken to insulate the supports of a charged body under ordinary conditions the rate of electrical leakage through the surrounding gas is exceedingly small, and appears to be the same whether the gas be dry or moist. A very significant fact, discovered by Kinnersley, of Philadelphia, more than a century ago, is that the steam from electrified water is uncharged, and the same has since been found to be true for other liquids. Such facts, and the insignificant leakage in a gas, as compared with the conductivity possible in the same gas under certain conditions, lead to the inevitable conclusion that a molecule of gas or vapor cannot act as a carrier of electricity. This is in harmony with the theory of electrolytic conduction, which assumes that the unmodified chemical molecule cannot receive a free charge.

As mentioned above, there is always an infinitesimal leakage in any gas, which cannot be attributed to the supports of the charged body. It is found that this leakage is proportional to the density

of the gas. At low pressure it is exceedingly small, and is less in small enclosures than in large ones. The conducting parts can be filtered out by passing the gas through glass, wool or porous material, and can be removed by a strong electric field. These facts suggest the presence in the gas of electrical carriers, relatively few in number as compared with the total number of molecules. As in electrolytic conduction, we may consistently assume that a certain fraction of the molecules are dissociated or otherwise modified so that they can become charged and act as carriers. In some cases the carriers appear to be projected into the gas from neighboring charged or uncharged bodies. The carriers are called ions, and a conducting gas is said to be ionized.

In the electrolysis of solutions there is no reason to believe that the ions are other than charged chemical atoms or radicals. It is found, however, that gases supposed to be monatomic, such as mercury, argon, and helium, will conduct electricity at low pressures better than many diatomic gases under similar conditions. This and other reasons to be mentioned later indicate that in many cases the ions must be quite different from the ions in electrolysis.

Accepting the assumption that electricity is transported through gases by charged particles, or ions, let us consider to what conclusions experimental evidence will lead us as to their nature and properties. The problem is a complex one, but we shall find it possible to arrive at fairly definite conclusions regarding the methods of ionization and the subsequent history of the ions, the ionic charge, mass and velocity, the size of ions, their distribution between electrodes, the validity of Ohm's law and of the electrolytic laws.

On account of the limitations of space only a few references to the most recent literature will be given.¹

Methods of Ionization.

For convenience, we may roughly divide the various methods of ionization into two classes. In class *A*, dependent upon electric stress, the conduction is negligible until a certain minimum potential difference between the electrodes has been attained, after which ionization goes on vigorously and the current passes with considerable intensity, usually accompanied by luminosity. These

1. Full details and bibliography may be found in J. J. Thomson's "Conduction of Electricity through Gases;" Stark's "Die Electricität in Gasen;" Rutherford's "Radioactivity;" Langevin's Paris Thèse.

types of discharge may be grouped under four subheads: (a) Spark; (b) arc; (c) point or brush; (d) vacuum tube discharge. There is no sharp differentiation between these types, but one may be made to pass into another by altering the distance between the electrodes, the source of current, or the conditions of pressure and temperature.

The second class, *B*, includes a number of methods by which a gas may be more or less ionized by external agencies so that it will conduct a current (usually a very small one) under the action of any potential difference, however small it may be. There are usually no luminous effects, although some exceptions may be noted: The luminosity of a flame appears to be dependent on ionization, and Huggins has shown spectroscopically that the so-called "spontaneous" luminosity of radium salts in air is really luminosity of the nitrogen bombarded and ionized by the corpuscles of radium. These ionizing agencies may be grouped under the headings; (e) cathode and Lenard rays, which have been shown to be negatively charged corpuscles, and canal or anode rays, positively charged corpuscles; (f) negative corpuscles similar to cathode rays emitted from zinc and other metals when exposed to ultra-violet light; (g) Röntgen rays; (h) Becquerel rays, the α , β , and γ components of which are in some respects similar to canal, cathode, and Röntgen rays respectively; (i) high temperature; (j) contact with incandescent carbon and metals, an effect probably due both to high temperature and to the emission of negative corpuscles from these solids; (k) chemical action; some gases set free by electrolysis or chemical reaction have a charge; (l) flames, a complex effect, probably due jointly to high temperature, chemical action, negative corpuscles from suspended solids, and the ultra-violet light of the flame (m) ultra-violet light directly absorbed by the gas; (n) heated sulphate of quinine,—probably due to molecular disturbances; (o) the splashing of water, which sometimes highly electrifies the air around the foot of waterfalls. There is, further, a "spontaneous" ionization in the atmosphere or enclosed gases, usually attributed to one or several of the above causes. This readily accounts for the small leakage found in all gases.

Diffusion and Recombination of Ions.

Ions appear to diffuse according to the gaseous laws; eventually they meet ions of opposite sign and recombine with them, or diffuse to the walls of the enclosure and there give up their charge. In

such ways ionization usually disappears a few seconds after the ionizing agent has ceased to act.

Observations on the rate of ionic diffusion made by Townsend and others show that it is greatest in hydrogen and least in heavy gases. A noteworthy fact is that the negative ion usually diffuses about 30 per cent faster than the positive; unless the gas is moist, when there is less difference. The rate of diffusion appears to be the same in a given gas at ordinary temperatures and pressures, whatever the ionizing agency may be.

The reduction of velocity of the negative ion in moist gas, and the fact that ions, particularly the negative, produce condensation of water vapor around them as nuclei, suggests that the negative ions in moist gas move more slowly because they are loaded down with water molecules. It is a remarkable fact that both positive and negative ions diffuse more slowly than the molecules of the gas in which they are formed. The conclusion is obvious that both ions may act as nuclei of condensation not only for water molecules, but also for molecules of any gas. These hypothetical clusters of molecules are sometimes called *molions*. Low temperatures might naturally be expected to favor their formation, and McClelland has actually found that the ions in flame gases diffuse more slowly as they are cooled.

Ionic Charge.

Certain relations between the ionic charge, speed, and coefficient of diffusion, pointed out by J. J. Thomson, make possible a fairly exact determination of the ratio between the ionic charge in gases and that of the hydrogen ion in electrolysis. Results calculated from the coefficients of ionic diffusion in a number of different gases show that in every case this ratio is very nearly unity for both positive and negative ions.

J. J. Thomson has further, by a very ingenious method, made a direct determination of the charge on the negative corpuscles from cathodes and from metals either incandescent or illuminated by ultra-violet light. It appears to be the same as the charge on the hydrogen ion in electrolysis, as determined from the electrochemical equivalent and the kinetic theory of gases.

These results make it highly probable that the ionic charge in gases is in all cases equal to the charge on the hydrogen ion in electrolysis. This is one of the postulates of the ionic theory.

In electrolysis the charge carried by an ion is proportional to the

valency of the ion. In this lies an important distinction between gaseous and electrolytic conduction.

Velocities of Negative Corpuscles and Ratio of Charge to Mass.

It has been shown that the cathode in electric discharges, metals and carbon heated to incandescence, certain metals exposed to ultra-violet radiation or Röntgen rays, and some radioactive substances, emit negatively charged corpuscles which appear to move with great velocity. They are subject to deflection in electric or magnetic fields, which makes it possible to determine from simple electrodynamic relations their velocity and the ratio of the charge e to the mass m . These results may be checked by other methods, depending on the relation between the electric energy, the kinetic energy of the corpuscles, and the heat developed by impact. J. J. Thomson first made such measurements, and they have been repeated by others, and by Becquerel for Becquerel ray corpuscles. The results are remarkably consistent, considering the experimental difficulties and the uncertainty of the necessary assumptions. The velocities found vary between 0.2 and 0.9 the velocity of light; the values for the ratio e/m between 0.6×10^7 and 2×10^7 in electromagnetic c. g. s. units. The value of e/m for the hydrogen ion in electrolysis is about 1×10^4 . If we accept the conclusion that the ionic charge is invariable and equal to that on the hydrogen ion, it follows that the mass of the negative corpuscles produced by various methods is about the thousandth part of that of the hydrogen atom. It seems to be the same whatever gases or electrodes are used.

But there seems to be an alternative conclusion. J. J. Thomson and others have shown that a free charge of electricity moving with a velocity comparable with that of light would have an apparent mass (self-induction) due to the diversion of kinetic energy to set up the electromagnetic field, this effect increasing with the velocity. Kaufmann found that the value of e/m for the very rapid corpuscles emitted by radium actually decreases somewhat with their velocity, and by an amount which has been shown by J. J. Thomson to harmonize almost exactly with his theory, assuming all the corpuscular inertia to be of electromagnetic origin.

Such negatively charged corpuscles of apparent mass much less than that of the hydrogen atom are called *electrons*. They are the indivisible unit of the atomic theory of electricity.

The Velocity and Mass of the Positive Ion.

Goldstein found that at low pressures luminous pencils—"canal rays"—pass through perforations in a cathode, away from the anode. They are deflected in an electric or magnetic field in a direction indicating that they are positively charged ions, either projected from the anode or arising from the ionization of the gas. Only in the steep potential gradient of the cathode do they acquire sufficient kinetic energy to excite luminosity, and in all probability their impact on the cathode greatly stimulates the projection of negative electrons. From their deflections in an electric and magnetic field Wien has determined their velocity and the value of e/m . Their velocity appears to be only the hundredth or thousandth that of the negative corpuscles, and the value of e/m is of the same order as that for the ions in electrolysis. J. J. Thomson has obtained similar values for the positive ions arising from red-hot platinum in an atmosphere of oxygen. These results indicate as wide a range of ionic masses as of the atomic weights; indeed in some cases molecular aggregates seem probable.

Spectroscopic Evidence.

Zeeman has found that the spectral lines of a source placed in a magnetic field are separated into polarized components, with distances apart proportional to the field. As shown by Lorentz, the simpler cases of this phenomenon can be accounted for by assuming that the sources of radiation are electrons revolving about atoms. One component of motion may be accelerated, another retarded, and the third unaffected, resulting in the observed doubling or tripling of the lines. All metallic lines appear to be affected; the gases have so far been little studied. We may, therefore, consider the radiation corresponding to line spectra as arising from ether disturbances synchronizing with the simple harmonic component motions of electrons revolving in atomic orbits, their periods being controlled by the size or structure of the atom.

Banded spectra are characteristic of compounds, and hence they have been supposed to arise from electrical disturbances within the undissociated molecule. Consistently with this view and with the idea that a molecule cannot be charged, it is found that a magnetic field has no influence on banded spectra.

From the change of period produced by the magnetic field the ratio e/m may be calculated. It has been found to lie between

1×10^7 and 2×10^7 . The state of polarization indicates, moreover, that the electrons have a negative charge. This is a striking confirmation of results obtained in other ways.

Ions in Gases at Ordinary Pressures.

At low pressures the negative corpuscles are projected with great velocity in definite directions by electric forces, but the ions produced in a gas at ordinary pressures move more slowly, like gaseous molecules. In an electric field they are subject to a directed velocity proportional to the electric intensity, and may thus be swept out of the field to the electrodes. If ionization steadily maintains the number n of each kind of ion per cubic centimeter, if E be the electromotive intensity, and u and v the respective velocities of the ions for a fall of potential of 1 volt per centimeter, the current delivered to the electrodes will be

$$i = E(u + v)ne.$$

If N ions are formed between the electrodes per second, the maximum current possible for any potential difference will be Ne . This is called the saturation current; u and v are called the specific ionic velocities.

Several ingenious methods of measuring ionic velocities, based on the above relations and the mechanical motions of the ions with gas currents, have been applied by Rutherford, Zeleny and others. The specific velocities thus measured are usually only a few centimeters per second. The ions in different gases appear to be different, the ionic velocities being much greater in a light gas such as hydrogen than in heavy gases. It seems doubtful whether the ions can be as small as atoms, for in all cases the negative ions move faster than the positive; and this would not be the case for the negative chemical ions of some gases, if velocity depends only on mass. Again we are thrown back on the hypothesis of molecular aggregates or molions, containing possibly between 10 and 30 molecules.

McClelland found that the ions of flame gases move more slowly as they grow cooler. Alkali salts in the Bunsen flame increase the conductivity, but the writer has recently found that the conductivity of the hot gases above the flame is greatly lowered by the introduction of the salt. This does not seem to be due to lowered temperature, but rather to smaller velocity or greater rate of recombination of the salt ions.

Mechanism of Ionization.

J. J. Thomson attributes the conductivity of metals and carbon to electrons diffused through them. It is not difficult to believe this when we find that these substances when incandescent will "evaporate" electrons in vacuo at an enormous rate, with small potential differences, if they form the cathode. Richardson² has found that at white heat a carbon cathode will give a saturation current due almost entirely to electrons as high as two amperes per square cm. Great electric stresses and in some cases the synchronous vibrations of ultra-violet light will also liberate these electrons.

The surrounding gas is ionized by the impact of the electrons. The positive ions so produced will, if the electric field at the cathode be great, return the blows with interest, and scatter fresh corpuscles from the cathode. That the bombardment of the cathode by canal rays produces such results is shown by the fact that a small object placed in the negative glow will stop the emission of cathode rays behind it; and it also casts a shadow of non-ionization before it. At low pressures there is a chance for these projectiles to acquire momentum; at high pressures they are so crowded and loaded down that they can do little damage. Herein seems to lie the secret of the fact that at high pressures a gas will not conduct to any great extent.

Thomson has shown that very high temperature will ionize most gases and vapors, but little is known as to the nature of the ions. The gases escaping from chemical reactions are sometimes charged, but their charges are erratic, and seem to have no relation to the charges of the same gas in electrolysis.

Relation between Luminosity and Ionization.

The spectroscope is of great assistance in investigating luminous discharges; because it has been shown that in most cases luminosity and conductivity, or ionization, are proportional. It may also give indications of the nature of the ionization, because, as said before, banded spectra appear to be characteristic of undissociated molecules; lines, of positively charged atoms with electron satellites. Electrons projected in straight lines do not appear to emit line radiation — at least there is no Doppler effect in the lines of the negative glow. It seems that the negative ion can take little part in radiation, except possibly in modifying electronic vibrations by its

2. Richardson, *Phys. Zeit.*, 5, 9, 1904.

presence. It surely cannot maintain an electronic satellite about itself. In this may lie the explanation of the fact that in the spectrum of a metallic compound, the lines of the metal are alone to be seen. We might expect the metal as a rule to become the positive ion on dissociation; to emit radiation it must in addition throw off a negative electron, the system as a whole remaining positively charged. That the luminous ions of a colored flame have a resultant positive charge is shown by the fact that the luminous part of a colored Bunsen flame is attracted by a negative electrode. Lenard³ has found for the luminous positive ions in the sodium flame a velocity of only .08, while Wilson and others observed velocities of from 100 to 200 for the conducting positive ions in such flames. This suggests that there may be at least two classes of positive ions.

The ease with which metallic vapors may be ionized by cathode rays is shown by the fact observed by the writer⁴ that the vapors of sodium, potassium, zinc, cadmium, magnesium and thallium will glow brightly when bombarded by rays from a distant cathode. A line spectrum is given, showing electronic dissociation. In vacuum tubes showing an afterglow the writer has also found that the vapors of such metals as mercury and aluminum may take an active part, emitting line radiation at least one-tenth of a second after the discharge has passed. The cause may be chemical or allotropic readjustment following the discharge, accompanied by changes in ionization.

Potential Gradient.

The potential gradient in a gas is greatest near the electrodes, the fall at the cathode being usually greater than that at the anode. An applied potential difference at least equal to the sum of the two — several hundred volts in most cases — is necessary to drive a current through the gas. As the temperature of the electrodes rises the electrode fall diminishes; thus in the carbon arc a comparatively small potential difference will maintain a current. In vacuum tubes the potential gradient is small in the Faraday dark space, and larger but uniform in the unstriated positive column. In conduction of type *B* there is a considerable fall near the electrodes, and a smaller uniform gradient between them.

If in any region the number of positive ions is greater or less

3. Lenard, *Ann. der Phys.*, 9, 642, 1902.

4. Lewis, *Astrophys. Journal*, 16, 31, 1902.

than that of the negative, there will be free positive or negative electrification — a condition never met with in metallic or electrolytic conduction. The volume density of the charge can be determined from the potential gradient by the application of Poisson's equation

$$\frac{d^2 V}{dx^2} = -4\pi\rho.$$

An inspection of the curves of potential gradient obtained by Graham shows that at the cathode there is a large excess of positive ions, an excess of negative at the anode and in the Faraday dark space, and equal numbers of each in the negative glow and the unstriated positive column.

Validity of Ohm's Law.

In electrolysis this law holds in all cases; in conduction through gases it is not generally true. In discharges of type *B* the current is proportional to potential gradient while this is small; with larger potential differences a limiting saturation current is approached, as the supply of ions becomes exhausted. In electrolytic conduction the current diminishes as the distance between the electrodes is increased; in this type of gaseous conduction it increases, because of the greater available number of ions.

In a vacuum tube of uniform cross-section there is great variation of conductivity, as tested by cross-electrodes. It is greatest in the negative glow, where corpuscular impact is greatest.

Ohm's law holds in the unstriated positive column, where the potential gradient is constant; it seems to hold in the striations likewise if proper account is taken of the free charges. Around the cathode it does not hold at all. The current is there largely carried by corpuscles projected with great velocities normal to the cathode, not following stream lines and sometimes even moving opposite to the local potential gradient. The difference is that between the flow of water in a pipe and its projection in a jet, in which case motion is no longer maintained by pressure.

Joule's law does not in general hold. The heat developed is not always greatest where there is the greatest potential gradient. The highest temperature is found at the cathode, and is probably a purely surface effect due to the bombardment of positive ions falling through the steep potential gradient; but on the other hand, there is a temperature maximum in the negative glow, where the potential gradient is least. When water flows in a uniform pipe, the develop-

ment of heat is most active where the pressure gradient is greatest; but the heat developed by a jet (or cathode corpuscles) is greatest where the particles are brought to rest by impact.

The apparent resistance in a vacuum tube is largely localized at the electrodes, and appears to be due to the energy required to eject electrons, or absorb them; for according to theory a charge can pass from metal to gas only in the form of electrons. The ohmic resistance is comparatively small, as shown by J. J. Thomson's experiments on the electrodeless discharge.

Traces of impurities such as water vapor and oxygen appear to have a considerable effect on the cathode fall of potential, and possibly on the degree of ionization. Observations are too meager, however, to justify any conclusions on this point at present.

Unipolar Effects.

The potential difference required to start a brush discharge from a point is much less if the point be a cathode than if it is an anode. As shown by Fleming, a current will readily pass from an incandescent carbon cathode to a cold anode, but not in the opposite direction. (Edison effect.) The ionization of a metallic vapor seems generally to go on more vigorously at the cathode. A bead of sodium salt held near the anode in a Bunsen flame or between the electrodes does not greatly increase the conductivity; but if held near the cathode the increase is great. Stark and Cassuto⁵ have recently found that an arc cannot be maintained unless the cathode is hot; it matters not how cold the anode may be. Weintraub⁶ has found that if ionization is started at a mercury cathode an arc will spring to a distant anode, whatever its material or temperature may be. Thomson believes that the vigorous emission of corpuscles from the cathode is necessary to maintain ionization; this corpuscular emission will set free positive ions which will in their turn by impact keep the cathode hot.

Division of Current between Components.

In mixtures of such gases as nitrogen or hydrogen with mercury or sodium vapor the spectra of both components will appear throughout the tube, the metallic lines being stronger at the cathode. E. Wiedemann found that when the metallic vapor is very dense it will completely extinguish the radiation (and presumably the con-

5. Stark and Cassuto, *Phys. Zeit.*, 5, 264, 1904.

6. Weintraub, *Phil. Mag.*, 7, 95, 1904.

duction) of the non-metallic gas, and the writer has found that minute traces of mercury vapor will greatly reduce the luminosity of nitrogen or hydrogen. This need not be attributed to any mysterious "metallic conduction" different in kind from that of the gas, but is probably due to the simple fact suggested before that the metal is more easily ionized. Stark⁷ has found that mercury vapor appears to be ionized by corpuscles from incandescent carbon with a cathode potential fall of only 11 volts, while nitrogen seems to require the greater kinetic energy corresponding to a fall of 27 volts. The arc can be maintained only with large quantities of carbon or metallic vapor present, this being more easily ionized than air; and Schuster and Hemsalech found by spectroscopic analysis that the initial spark of oscillatory discharge passes through air, while succeeding sparks pass by preference through metallic vapor set free by the first spark.

Electrolysis in Gases and Vapors.

The band spectra due to feeble discharges through a compound vapor show that some sort of ionization may exist without molecular dissociation. As shown by E. Wiedmann and Ebert, HgCl_2 vapor in a vacuum tube will give a band spectrum, and the absence of mercury lines is conclusive evidence that there is no dissociation. With strong discharges, however, the mercury lines appear, and in most cases a vigorous discharge is certainly accompanied by dissociation. Whether the ions are the same as those in electrolytic conduction is, however, another question. Some facts have been held to prove that they are. Perrot found that the spark discharge through water vapor freed an excess of hydrogen at the cathode and of oxygen at the anode, in equivalent proportions; but J. J. Thomson found that with a very short spark (arc) the excess of hydrogen appeared at the anode. The deficiency of oxygen at the hotter electrode in each case suggests that the dissociation may have been due in part to heat, and the deficiency of oxygen to oxidization. Wiedemann and Schmidt observed a slight excess of chlorine at the anode in the discharge through HCl , but it was far short of the amount required by Faraday's law. From the fact that the hydrogen spectrum is brighter at the cathode, that of chlorine at the anode, in a vacuum tube, Thomson concluded that there was electrolytic separation; but Morris-Airey showed that there was no appreciable difference of

7. Stark, *Phys. Zeit.*, 5, 51, 1904; also Merritt and Stewart, *Phys. Rev.*, 18, 239, 1904.

concentration of the two gases at the electrodes. Such effects may in part be due to differences of temperatures between the electrodes, but the fact that metallic elements are more readily dissociated than non-metallic would alone explain the greater brightness of the positive element at the cathode where ionization is most active in all forms of discharge. It is significant that nothing corresponding to electrolytic polarisation has ever been demonstrated in discharge through gases.

To sum up, the conductivity of a gas or vapor seems undoubtedly to depend on ionization, but in several respects this appears to be different from that in electrolytes. As conduction may take place in an elementary gas, its atom must be able to take either a positive or a negative charge; the ionic charge is invariable, not proportional to valency; Ohm's law does not in general hold; volume charges of electricity are possible; instead of only two kinds of ions there are several. No doubt the positive carriers move toward the cathode, the negative toward the anode, but this cannot result in electrolytic separation of the chemical components in definite proportions because ions of both kinds and of various magnitudes may exist for both elements. If we accept the electron theory, the current through HCl, for example, may be initiated by ionization due to electrons. There may be more or less chemical dissociation; the resulting H and Cl atoms may each be either positively or negatively charged by the ejection or absorption of a corpuscle. Some of these ions may become nuclei of molecular aggregates of different sizes. At the anode the current may be delivered by carriers consisting of negative electrons, hydrogen ions, chlorine ions, hydrogen molions, chlorine molions, and HCl molions; and similarly at the cathode. With such a medley, it is not strange that no law of definite electrolytic separation has been established.

For many years the investigation of electrical discharges and of spectroscopic phenomena has been rather ineffective because a unifying and suggestive theory was lacking. Thanks to the labors of such men as J. J. Thomson, this lack has been at last supplied, by the electron theory and problems which seemed altogether hopeless are yielding to this new method of attack.

In view of a growing tendency to abandon the use of all scientific hypothesis and confine investigation to the measurement of observed energy relations, it may not be out of place to ask the question: "How much progress would have been made in these directions without a daring use of the imagination?"

ON THE RADIOACTIVITY OF MINERAL OILS AND NATURAL GASES.

BY PROF. J. C. McLENNAN, *Toronto University.*

I. RADIOACTIVE EMANATIONS FROM ORDINARY MATERIALS.

In the course of their investigations on the radioactivity of the atmosphere, Elster and Geitel¹ have shown that the soil and rock-masses constituting the surface layers of the earth are the source of an emanation, or gas, which gradually escapes into the air, and there exhibits properties analogous to the radioactive emanations from thorium and radium. In a conjoint paper by Mr. E. F. Burton and myself² on the conductivity of air confined in receivers of different metals, some observations are cited which indicate that metals generally are, to a slight degree, the source of a similar emanation. This result has since been confirmed by Strutt,³ who found that air drawn through a glass tube, heated just below redness and containing scrap copper, acquired a conductivity three or four times its normal value. Strutt³ has also shown that a highly radioactive emanation can be obtained by bubbling air through mercury heated to about 300° C. More recently, Professor J. J. Thomson⁴ established the existence of a radioactive gas in the Cambridge tap-water, as well as in the water from a number of wells in different parts of England. Similar results have been obtained by Himstedt⁵ at Freiburg, and by Lord Blythwood and H. S. Allen⁶ with the mineral waters of Bath. Later still Adams⁷ made a careful study of the radioactive gas in Cambridge tap-water, and his results, as well as those of Strutt on the emanation from mercury, go to show that the activity in all these cases is

1. *Phys. Zeit.*, 3 Jahr. 24, p. 574. Denkschr. d. Kommission für luft-elect. Forschungen (München, 1903).

2. *Phil. Mag.*, 5th series, June, 1903, p. 699.

3. *Phil. Mag.*, 6th series, July, 1903, p. 113.

4. *Proc. Camb. Phil. Soc.* XII. 3, 1903, p. 172.

5. *Berichte der Naturf. Ges. von Freiburg I. B.*, 1903, XIII, p. 101.

6. *Nature*, Jan. 14, 1904, p. 247.

7. *Phil. Mag.*, 6th series, November, 1903, p. 563.

due to the presence of a substance very similar to, if not identical with, the emanation from radium.

In the following paper an account is given of some experiments by Mr. E. F. Burton⁸ with a highly radioactive gas obtained from crude petroleum, together with an extension of these experiments and some additional observations made by the writer upon the electrical conductivity of a number of the natural gases of Western Ontario. The results of the investigation show that the petroleum and the natural gases examined, when freshly drawn from the wells, were charged to a greater or a less degree with an active emanation, which, both in the rate at which its activity died out, and in the nature of the induced radioactivity it produced, very closely resembled the emanations dealt with by the investigations mentioned above.

II. GEOLOGY OF THE ONTARIO OIL AND GAS FIELDS.

The greater part of the petroleum used in the experiments was obtained from some of the older wells at Petrolia⁹ where the oil is drawn directly from the corniferous limestone, which in that locality lies at a depth of four hundred and sixty-five feet below the surface. The remaining portion was obtained from a well recently sunk near the city of Brantford, the source being the Medina formation, which is much lower in the Geological scale than that of the Petrolia oil field. The log of this well as furnished by the drillers is as follows.

8. University of Toronto, Studies, Physical Science Series, p. 35, 1904.

9. The writer wishes to acknowledge his great indebtedness to Mr. A. C. Edward of Petrolia and Mr. Shuttleworth of Brantford for samples of oil furnished during the course of the investigation, and to Mr. Eugene Coste of Toronto and Mr. W. J. Aikens of Brantford, both of whom kindly afforded him every facility for studying the natural gases of the fields under their control.

REPORT OF WELL No. 1, "BOW PARK FARM." Drilled Feb., 1904.

Formation.	Strata.	Thickness	Depth
		(feet).	(feet).
Drift	Surface clay and sand	18	18
	Blue clay	30	48
	Quicksand	10	58
Onondaga.....	Hard pan	10	68
	White limestone	267	335
Niagara	Black shale	40	375
Clinton	White limestone	15	390
Medina.....	Red limestone	40	430
	Blue shale.....	20	450
	Sand rock.....	20	470
	White limestone	15	485
	Rock and shale.....	5	490
	Red shale.....	112	602

NOTE.—Surface water shut off at 73 feet. Deep water shut off at 338 feet. Gas struck at 490 feet, pressure 232 pounds per square inch.

The natural gases investigated were obtained chiefly from the wells which constitute the Welland field in the neighborhood of Niagara Falls. These wells are of varying depths, and the Niagara, Clinton, Medina and Trenton formations are the horizons from which the gas is drawn. The following logs¹⁰ of two of the wells of the group illustrate fully the underground geology of the Welland district.

WELL No. 22, POINT ABINO, "BERTIE TOWNSHIP." Elevation 580 feet.

Formation.	Strata.	Thickness.	Depth.	Remarks.
Drift.....	Sand	10	10	
Corniferous.....	Grey limestone with flint....	82	92	
Onondaga	Grey and drab dolomites, blue shales and gypsum ...	368	460	
Guelph and Niagara..	Grey dolomites	235	715	Gas in large quantities at 500, 530 and 580 feet. Salt water at 600 to 630 feet.
Niagara shales	Blue shales.....	55	770	
Clinton	White limestone.....	60	800	
Medina.....	Red sandstone.....	80	880	
	Blue shale.....	18	898	
	White sandstone	17	910	Gas at 908 feet.

10. Eugene Coste, Natural Gas in Ontario. *Proc. Can. Mining Inst.* 1900.

WELL No. 61, LOT 2, IN 4TH CONCESSION, WILLOUGHBY TOWNSHIP. Elevation 610 feet.

Formation.	Strata.	Thickness (feet).	Depth (feet).	Remarks.
Drift.....	Clay.....	18	18	
Onondaga.....	Dolomites and shale with gypsum	203	220	
Guelph and Niagara..	Grey dolomites	220	440	Salt water at 330 feet.
Niagara shale	Blue shale.....	50	490	
Clinton	White limestone	30	520	A little gas at 495 feet and a little salt water.
Medina	Red sandstone and shales....	73	593	
	White sandstone	10	603	
	Blue shale.....	12	615	
	White sandstone	18	633	
	Red shale.....	890	1,463	
Hudson river	Blue shale.....	717	2,180	
Utica	Black shale	160	2,340	
Trenton	White and grey limestone...	670	3,010	Gas at 2,940 feet 1,000 pounds per square inch, original rock pressure.
Calcareous	Grey coarse sandstone.....	19	3,029	
Archean	White quartz.....	1	3,030	

With a few exceptions, the wells of the Welland field contain no petroleum, and the gas, as in other fields in America, is found in isolated pools or pockets in porous rocks, often exerting enormous pressures. At the present time, this field comprises nearly two hundred wells, the first of which was drilled in 1889. A record of the initial rock pressures of these wells has been preserved and it shows a characteristic pressure for each stratum. In the Guelph dolomite the original rock pressure of the gas was about 300 lbs. to the square inch, in the Clinton limestone 400 lbs., in the Medina white sand 525 lbs., and 1000 lbs. in the Trenton limestone. In all the wells, the pressure is decreasing more or less rapidly according to the amount of the gas withdrawn.

In the Brantford district which is a new field, eleven wells have been drilled recently and with one exception they all contain either gas or oil. Generally they contain both. The gas pockets, however, are not as large as those of the Welland field and the supply of oil is small compared with that of the Petrolia area.

III. A RADIOACTIVE EMANATION IN CRUDE PETROLEUM.

In conducting the experiments with petroleum, the tests were made with oil as fresh as possible, but as Petrolia is about 300 miles distant from Toronto, twenty-four hours generally elapsed from the time when the oil was pumped until measurements were begun. The petroleum to be tested was contained in a large three-litre flask, *D* (Fig. 1), supported in a water-bath. This flask was connected to a wash bottle *E*, partly filled with concentrated sulphuric acid, and to a second flask, *F*, embedded in ice, for the purpose of condensing any vapors from the heated oil. The tube, *G*, was filled with phosphoric pentoxide, and the tube *H*, tightly packed with glass wool. The vessel *A*, made of thin galvanized iron, 62 cms long and 25 cms in diameter, was provided with an exploring elec-

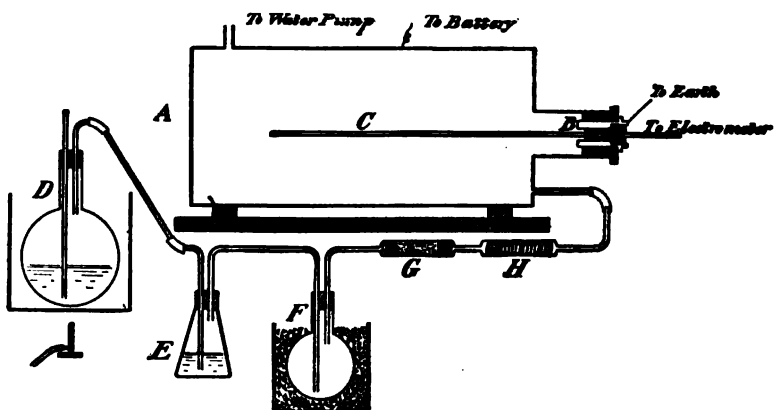

FIG. 1.

trode, *C*, which was supported by an ebonite plug carrying a guard tube, *B*. The rod, *C*, was connected to one of the pairs of quadrants of a quadrant electrometer of the Dolzaleck type, whose sensitiveness was such that a potential difference of one volt between the quadrants gave a deflection of 1,100 mms on a scale at a distance of one metre. Throughout the experiments the cylinder, *A*, was maintained at a potential of 168 volts by a battery of small storage cells, and the conductivity of the gas which it contained was determined by measuring the saturation current to the exploring electrode. This saturation current when the cylinder, *A*, was filled with ordinary dry air was about 16.5 scale divisions per minute. After heating the water in the bath to the boiling point,

air was bubbled for fifteen minutes through the oil and drawn into the cylinder, *A*, by means of a water pump. The cylinder was then disconnected from the tube, *H*, and hermetically sealed, after which measurements were made from time to time, on the conductivity of the gas which it contained. The density of this gas was determined, and in the different tests found to be about 1.05, air being taken as unity.

On first introducing into the cylinder the air which had passed through the oil, it was found to have an initial conductivity very greatly in excess of that of normal air. Its conductivity steadily increased after the cylinder was closed for about three hours, when it reached a maximum value, after which it slowly decreased approximately in a geometrical progression with the time. Fresh air passed through different samples of petroleum into the cylinder under exactly similar conditions was found to possess different initial conductivities, but, in every case, the conductivity of the confined air steadily rose in about three hours to a maximum about 40 per cent. in excess of the initial value. It then decayed according to an exponential law, always dropping to one-half value in a little over three days. Typical sets of observations on the conductivity of air bubbled through samples of oil from Petrolia and also from Brantford are given in Table I, the time being reckoned from the moment when the cylinder was closed.

TABLE I.

Time.		Current.	Time.		Current.
Hours.	Minutes.	Arbitrary Scale.	Hours.	Minutes.	Arbitrary scale
PETROLIA OIL.					
....	10	99	37	99
....	30	95.6	41	30	88.5
1	4	108	50	77.8
1	35	111.7	67	71
2	8	116.5	73	30	67.7
2	43	119.7	95	60.3
9	30	111.6	116	30	55.5
20	101	123	50.8
23	95.7	133	30	48.6
BRANTFORD OIL.					
....	5	243.2	23	236.2
....	25	230.3	44	232.7
....	55	314.3	51	229.7
2	5	345.3	71	206.5
2	355.7	117	137.4
2	45	356	123	82.4
5	346	212	70
20	309.3			

These results are shown graphically in Fig. 2, where the ordinates of the curves represent the conductivity of the gas, and the abscissae the times in hours.

As in the experiments of Professor Thomson with the Cambridge tap-water, and those of Strutt with mercury, all of the observed phenomena lead to the conclusion that the air, in passing through

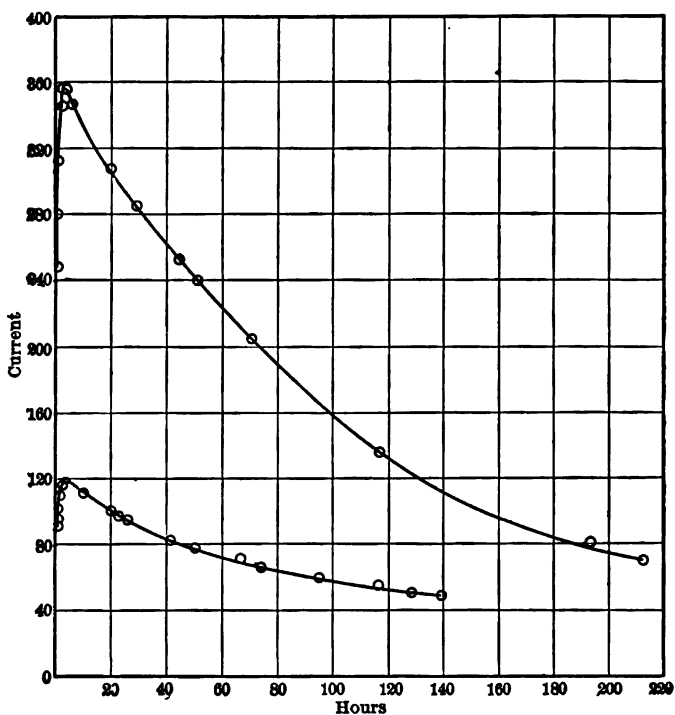

FIG. 2.

the petroleum, becomes mixed with some radioactive gas or emanation. The initial portion of the curve leading up to the maximum corresponds exactly to that of the curve given by Rutherford¹¹ for the emanation from radium, and also to that of the curve given by Strutt for the radioactive gas obtained by bubbling air through mercury and may be explained in the same way. The value of the conductivity immediately after the cylinder has been sealed measures the ionization due to the emanation itself. But, according to

11. *Phil. Mag.*, 5th series, April, 1903, p. 445.

the disintegration theory proposed by Rutherford, the emanation is continuously producing by its decay the matter which causes excited radioactivity, and the ionizing power added by this latter material more than neutralizes, for a time, the decrease due to the decay of the emanation. Thus the conductivity of air freshly charged with this emanation gradually increases to a maximum state, which is reached when the loss in the ionizing power due to the decay of the emanation is just equalled by the gain contributed by the excited radioactivity produced in this process of decay.

From this time, the rate of change indicated gives the rate of decay of the emanation. The law which the rate of decay of the emanation from radium follows may be expressed by the equation:

$$I_t = I_0 e^{-\lambda t}.$$

Where I is the value of the conductivity at any given time, I_0 the value after an interval of t seconds, e the base of natural logarithms and λ a constant. By using this equation the values of $\frac{1}{\lambda}$ have been determined for a number of pairs of the readings given above and the results are tabulated in Columns I and II, of Table II. In deducing these values an allowance of 16.5 divisions per minute was made for the ordinary conductivity of the gas.

It will be noticed that with the emanation from the oil of both districts, the maximum conductivity was obtained in about three hours after the receiver was closed. The rates of decay in both cases were also practically the same, one-half value being reached with the Petrolia oil in 3.4 days and in 3.2 days with the Brantford sample.

An extensive series of tests made with the Petrolia oil showed it to be less highly charged with the active emanation than the oil from Brantford. In no case was the conductivity of the air drawn through the former greater than one-third that of the air drawn through the latter.

TABLE II.

Column I.			Column II.		
(Petrolia oil.)			(Brantford oil.)		
Time in hours.	Current arbitrary scale.	$\frac{1}{\lambda}$	Time in hours.	Current arbitrary scale.	$\frac{1}{\lambda}$
0	119.7	306,184	0	356	374,750
17	101	386,470	24	286.8	437,647
47	77.8	530,636	47.3	289.7	440,578
64	71	470,984	67.3	206.5	366,937
92	60.3	492,887	113.3	187.4	451,831
185.6	48.6	189.3	62.4	340,868
....	208.3	70
Mean value of $\frac{1}{\lambda} = 425,430$			Mean value of $\frac{1}{\lambda} = 408,542$		
Half value in 8.4 days.			Half value in 8.3 days.		
Column III.			Column IV.		
Strutt. (Mercury.)			Adams. (Cambridge water.)		
Time in hours.	Current arbitrary scale.	$\frac{1}{\lambda}$	Time in hours.	Current arbitrary scale.	$\frac{1}{\lambda}$
0	140	379,000	0	188	366,000
18	118	389,000	16.7	160	401,000
42	94.5	472,000	40.4	129	494,000
66	78.7	504,000	64.8	108	381,000
90	66.3	371,000	88.9	86	372,000
140.5	40.6	139.6	58	573,000
....	160.8	46
Mean value of $\frac{1}{\lambda} = 423,000$			Mean value of $\frac{1}{\lambda} = 425,000$		
Half value in 8.18 days.			Half value in 8.4 days.		

In Column III of Table II a set of Strutt's readings is given for the ionization due to the radioactive gas in mercury, and in Column IV the values obtained by Adams with the active emanation in

Cambridge tap-water. The calculated values of $\frac{1}{\lambda}$ are inserted in both cases, and agree fairly well with those given in Columns I and II.

In his experiments with the water from the Cambridge mains, Professor J. J. Thomson found that when the water had once been well boiled, the gas expelled on any subsequent re-boiling was not appreciably radioactive. In the present investigation, air was drawn through a selected sample of the Petrolia oil into the cylinder on three consecutive days and again on the sixth day, the first measurement being made about 24 hours after the petroleum had been pumped from the well. Each time the oil was used, the bath was brought up to the boiling point and the air bubbled through it for 15 minutes, when observations on the conductivity of the air in the cylinder were commenced and continued at intervals over a period of about 20 hours.

TABLE III.

Time.		Current.	Time.		Current.
Hours.	Minutes.	Arbitrary scale.	Hours.	Minutes.	Arbitrary scale.
Curve I.			Curve II.		
....	10	158.7	30	80
....	30	174.2	1	88.4
1	5	196.7	1	30	87.2
1	30	208.7	3	40	92.6
1	50	214.2	5	92
2	30	222.5	16	84.3
3	30	226
4	224.2
8	15	211.1
22	176
Curve III.			Curve IV.		
....	40	49	35	29.6
3	10	53	55	30.3
13	43	3	31.6
24	41.0	22	25.2

The results, which are embodied in Table III, and illustrated by the curves in Fig. III, show that the activity acquired by fresh air when drawn through the oil gradually decreased from day to day. The curves corresponding to the different tests exhibit the same characteristics as that in Fig. II. In each case the conductivity rose to a maximum in about three hours, and then gradually decreased. The maximum currents in the four trials were

respectively 13.9, 5.6, 3.2, and 1.9 times the conductivity of the ordinary air, thus showing that the oil at the end of a week still possessed in a marked degree the power to impart radioactivity to air drawn through it. Experiments made with a sample of oil which had been used in some preliminary tests and had been placed aside in a tightly corked glass vessel for over a month, gave values

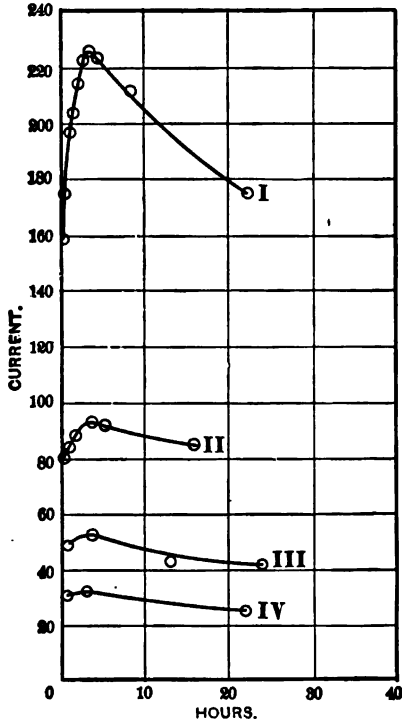

Fig. 3.

almost identical with those represented by Curve IV, Fig. III, the maximum conductivity impressed in this case being 1.6 times that of the normal air. From these results it would appear that there is present in crude petroleum, at least in some samples, an active substance more persistent than the emanation from radium, perhaps a minute quantity of radium itself.

IV. A RADIOACTIVE EMANATION IN NATURAL GAS.

In conducting the experiments with natural gases, the same method was followed as that adopted in measuring the conductivity of the air drawn through petroleum. The wells tested were all piped and, at the time the experiments were made, were providing a supply of gas for consumption in the neighboring towns and cities. In making a test the cylinder *A* was taken to one of the wells and filled with fresh gas. The conductivity of the gas was then measured by means of the quadrant electrometer described above, which in these experiments possessed only a moderate sensitiveness, a difference of potential of 1 volt between the quadrant giving a deflection of 600 mms on a scale at a distance of 1 metre. The saturation current when the cylinder *A* was filled with air was about 11 scale divisions per minute.

As many of the wells were situated at a considerable distance from the testing station, it was generally between two and three hours after the gas was drawn from the well before measurements on the conductivity were begun.

As already stated, the wells in the Welland field fall into four groups. The majority of them have their source in the Medina formation, a considerable number in the Clinton stratum, a few in the Niagara limestone and one, which is exceptionally deep, penetrates the Trenton limestone, which is only a few feet from the quartz. The first measurements were made on gas from the Clinton formation. Some 20 or 30 wells, having their source in this stratum, are located in the neighborhood of Port Colborne and provide the gas supply for this town. Samples of this gas, taken from the mains on several different days, showed a uniform conductivity of about 110 scale divisions per minute, which was about ten times that observed for ordinary air. Tests made on the gas of a number of individual wells of this group, showed but little variation from this rate. In one case, however, a conductivity as high as 313 was obtained, and in another a conductivity as low as 40. The high conductivity was obtained with gas from one of the first wells sunk in the district, while the low value was obtained from a well which had been flowing but a few months. The average of all the measurements on the conductivity of the gas from the wells in the Clinton formation was 145.

The second set of wells examined consisted of those belonging

to the Medina group. Ten of these wells, which have been flowing for about three or four years, are connected together and furnish part of the supply for the city of Buffalo. Measurements made on the gas from the mains of these wells gave an average conductivity of 745 scale divisions per minute, which is considerably higher than that of the gas from the Clinton horizon. A test made on one individual well from this formation, outside the group just mentioned, gave a conductivity of 770, while still another gave 947. The well which gave this high conductivity had been flowing for about fourteen years. One cannot conclude however that high conductivity is always characteristic of the gas from the older wells, for in one instance one of the oldest Medina wells tested gave a conductivity of only 260 divisions per minute. The average conductivity for all the wells of the Medina group was 680.

An opportunity was afforded of examining the gas from two wells, whose source was in the Guelph or Niagara limestone. The conductivity of one of these wells was found to be 1420, and that of the other 915. This gas, unlike that from the other horizons, contained about one per cent of hydrogen sulphide. It also possessed the highest conductivity of all the gases tested in the Welland field, the average of the two wells being 1168.

The deepest well tested was one which terminated in the Trenton formation. It had been sunk as an exploring well when the gas field was first opened up, and, when drilled, showed the enormous rock-pressure of 1000 pounds per square inch. The supply of gas from this well proved less than that from many of the wells which were not so deep, and which did not exhibit such high initial pressures. At the present time, its pressure is not greater than 100 pounds per square inch. The conductivity of its gas was found to be 147 on the same scale as those given above.

During the course of the investigation, the gas from one of the wells of the Medina group was examined upon a number of successive days and, while variations in the conductivity were observed, none of them exceeded five per cent of the average value.

Summarizing the results obtained in the Welland field, it would appear that the gas from each of the horizons possesses a characteristic conductivity, which, as will be seen later, is very probably due to the presence in varying amounts of an active emanation similar to that found in crude petroleum. The great differences observed cannot be due to variations in the density of the gases, for chemical

analyses have shown that with the exception of the gas from the Niagara limestone, all of the gases from the Welland field have practically the same composition, about three per cent being nitrogen, and the remainder hydrocarbons of the paraffin series.

The average conductivity corresponding to the different strata, together with the approximate depths of the formations, are given in Table IV.

TABLE IV.

Source of the gas.	Average conductivity arbitrary scale.	Approximate depth of formation (feet).
Niagara formation.....	1,168	500
Clinton "	145	750
Medina "	680	900
Trenton "	147	8,000
Medina (Brantford).....	8,405	600

After concluding the experiments in the Welland field, the gas from one of the wells near the city of Brantford was examined. This well is one of a number which have been drilled but recently. They all have their source in the Medina formation, and most of them contain oil as well as gas. Their pressures are small compared with the wells in the Welland field, and from present indications the output of gas from them is not likely to be considerable. The conductivity of the gas from this well proved to be exceedingly high and it was found necessary to add a capacity to the electrometer in order to accurately record the movement of the needle. The conductivity reduced to the same scale as that adopted in the Welland observations was 8404.5. It is interesting to note that this high conductivity was obtained with gas which was in close association with crude petroleum and especially with the oil which was found to be the most highly charged with a radioactive emanation.

A series of observations was made upon the conductivity of this gas with a view to ascertaining the number of ions produced in each cubic centimetre of its mass per second. The effective capacity of the electrometer and its connections was found to be about 190 centimetres and the mean of a number of determinations gave 14,968 as the number of ions produced per second at normal pressure in each cubic centimetre of the gas, about three hours after it had been taken from the well. In making this determination,

the charge on one ion was taken as 3.4×10^{-10} electrostatic units.¹² A similar series of observations gave 32 as the number of ions produced per second in each cubic centimetre of ordinary air, when confined in the receiver used in measuring the conductivity of the natural gas. The conductivity of this sample of natural gas was, therefore, about 500 times that of normal air, which is probably the highest conductivity hitherto observed in gases having their source in the earth's crust.

TABLE V.

<i>Brantford Gas.</i>			<i>Welland Gas.</i>		
Time.		Current.	Time.		Current.
Hours.	Minutes.	Arbitrary scale.	Hours.	Minutes.	Arbitrary scale.
....	8404.5	469.2
2	30	7701.1	36	460
6	7042	5	389
24	30	5502.6	17	339
50	4585	19	331
76	15	3495.5	24	327
101	2715.8	40	307
130	2059.1	48	30	248
176	45	1841.0	64	30	221
197	30	1033.7	90	168.2
224	765.6	112	137
....	137	112
....	161	92.8
....	187	80
....	214	65.3
....	236	58.5
....	262	46.2
....	312	42.4
....	364	33.5

In order to see whether the high conductivity of the natural gases was due to the presence of a radioactive emanation, observations were made over an extended period and it was found that the saturation current through a mass of the gas, confined in the receiver *A*, Fig. 1. diminished progressively and fell to half value in about three days. In Table V. the results obtained with a sample of the gas from Brantford, as well as with one from the Welland field, are recorded, the time being reckoned from the first reading which was made, as already stated, about three hours after the gas was taken from the well. Curves representing these values are given in Figs. 4 and 5. As the numbers show, the conductivity fell in the case of the Brantford gas to half value in 2.76 days, while with the

12. *Phil. Mag.*, Vol. V, p. 346, 1903.

Welland gas the decay was not quite so rapid, the half value being reached in 3.11 days. It is possible that some of the emanation may have escaped from the receiver while the observations were being

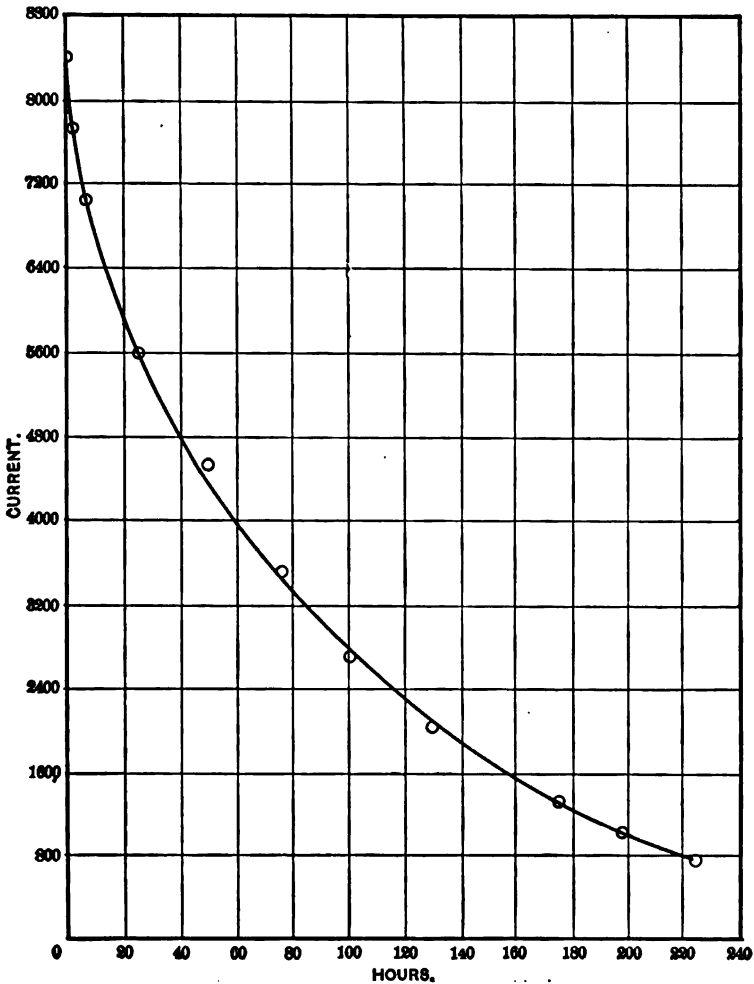

FIG. 4.

made upon the Brantford gas, although special care was taken to have the vessel hermetically sealed. Such a loss would account for the low rate of decay obtained. Possibly, too, the difference in

the ranges over which the observations were made may have had some bearing upon the variation in the results. Assuming the law of decay to be represented by $I_t = I_0 e^{-\lambda t}$ the values of $\frac{1}{\lambda}$ have been calculated for the two sets of observations and are shown in Table VI.

The averages of the four series of values of $\frac{1}{\lambda}$ given in Table II and of the two series in Table VI are given in Table VII. The

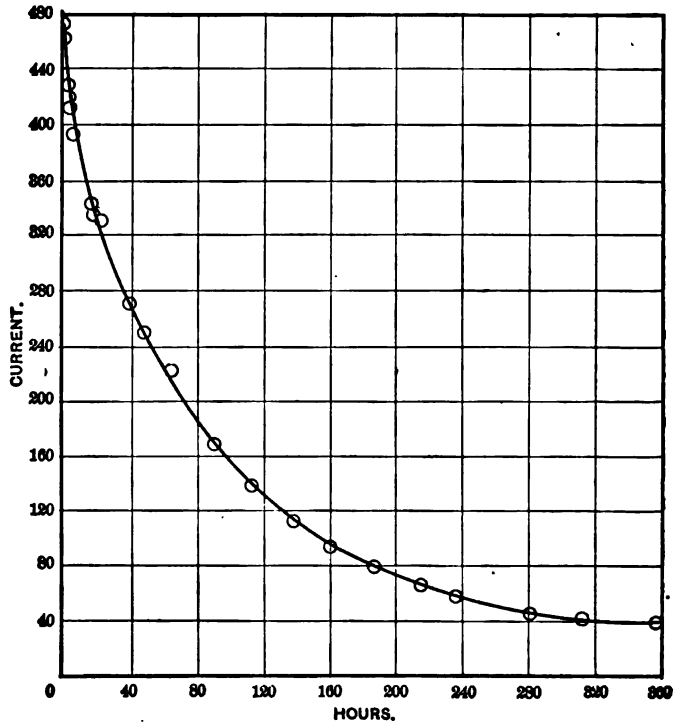

FIG. 5.

mean values of the same constant obtained by Mme. Curie¹³ and by Rutherford¹⁴ for the decay of the emanation from radium as well as the mean value calculated from Himstedt's result for the radioactive gas in water are also added. The values show a very

13. Thèses prés. à la Faculté des Sci. de Paris 1903.

14. *Phil. Mag.*, 5th series, April, 1903, p. 445.

fair agreement, and lead to the conclusion that the active substances in natural gases, petroleum, spring water and mercury, are very probably identical with the emanation from radium.

TABLE VI.

Column I.			Column II.		
<i>Brantford Gas.</i>			<i>Welland Gas.</i>		
Time in hours.	Current arbitrary scale.	Seconds.	Time in hours.	Current arbitrary scale.	Seconds.
0	8,404.5	213,787	0	469.2	233,431
24.5	5,569.6	449,394	24	329	304,530
50	4,535	363,210	48.5	248	447,331
76.25	3,495.5	282,857	64.5	200	313,356
101	2,715.8	237,031	90	168.2	345,230
130	2,059.1	191,773	112	137	336,353
176.75	1,341	106,417	137	112	337,201
197.5	1,038.7	818,053	161	92.8	513,333
224	755.6	187	80	372,471
.....	214	65.3	533,031
.....	236	58.5	434,002
.....	262	46.2	
Mean value of $\frac{1}{\lambda} = 344,308$			Mean value of $\frac{1}{\lambda} = 392,239$		
Half value in 2.76 days.			Half value in 3.11 days.		

TABLE VII.

Experimenter.	Source of Emanation.	Value of $\frac{1}{\lambda}$
Mme. Curie.....	Radium.....	497,000
Rutherford.....	Radium.....	453,000
Strutt.....	Mercury.....	423,000
Adams.....	Tap-water.....	425,000
Himstedt.....	Water.....	491,000
Burton.....	Petroleum (Petrolia).....	423,430
McLennan.....	Petroleum (Brantford).....	403,542
McLennan.....	Natural Gas (Brantford).....	344,303
McLennan.....	Natural Gas (Welland).....	392,239

V. EXCITED RADIOACTIVITY FROM PETROLEUM.

In his experiments, Burton found that when air containing the emanation from crude petroleum had been allowed to remain in the testing cylinder for some time and was then replaced by fresh air from the room, the saturation current through the new air still remained abnormally high. Repeated tests showed that the initial conductivity of this fresh air was about 35 per cent of that of the displaced gas, but in every case it rapidly died down, until, after about two hours, the conductivity reached its normal value.

TABLE VIII.

Time in minutes.	Current : Arbitrary scale.
5	73.8
15	58.2
25	50.6
35	47.2
45	41
55	35.6
65	35.4
75	32
91	26
200	16.7

The results of one of these tests are given in Table VIII. In this particular case, the cylinder, while filled with the air containing the emanation, was maintained at a negative potential of 168 volts for 22 hours and during this time the conductivity rose from its initial value of 158.7 to a maximum of 226 and then fell to 176.3.

At this stage a blast of air was sent for five minutes through the testing cylinder after which it was sealed up and measurements on the conductivity of the newly admitted air begun. The curve given in Fig. 6, in which the ordinates represent currents and the abscissae intervals of times, illustrates the results in Table IX. From this curve it is seen that the conductivity decreased in a geometrical progression with the time, falling to one-half value in about 35 minutes. This phenomenon is exactly analogous to that which other investigators have found in working with the radioactive emanations from thorium and radium and which has been explained on the assumption that these emanations have but a transitory existence and are gradually transmuted into a new substance which has a definite rate of decay and which is the cause of the so-called induced or excited radioactivity. On this view it is clear from the observations above, that the active emanation from

petroleum also produces the substance which is responsible for induced radioactivity, and that the presence of this substance in the cylinder is the cause of the high conductivity of the fresh air which replaced that blown out.

An experiment giving similar results was conducted under the same conditions as that just described, except that the cylinder was maintained for 22 hours before the emanation was expelled at a positive potential of 168 volts. This would show that the substance

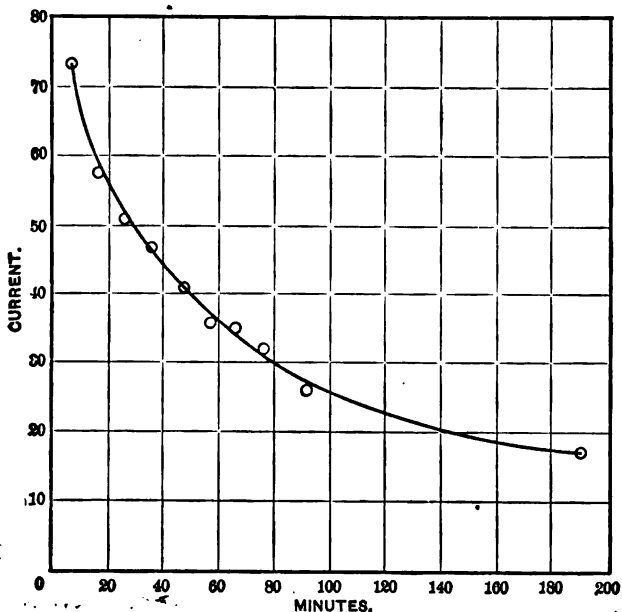

FIG. 6.

responsible for excited radioactivity was left in the cylinder in both cases when the air was blown out. As it is known that negatively charged conductors in the presence of radioactive emanations become more active than those positively electrified, it is very probable that in the first experiment the excited radioactivity was deposited on the walls of the receiver, while in the second case it was concentrated upon the electrode, *C*.

A confirmation of this conclusion was obtained by exposing a conductor under negative electrification, and then under positive, to the petroleum emanation. The exploring electrode, *C*, was taken from the cylinder, *A*, and suspended in a large glass tube through which air containing the radioactive emanation was drawn. It was

connected for half an hour with the negative terminal of an electrical machine giving a potential of about 10,000 volts, and on being replaced in the receiver it increased the conductivity of the air to about three times its normal value. The conductivity in this case fell to a half value in the same time as before. When the exploring electrode was suspended under a positive electrification of 10,000 volts for the same time in the current of air containing the emanation, it did not acquire any appreciable activity.

VI. EXCITED RADIOACTIVITY FROM NATURAL GAS.

A confirmation of the conclusion that the abnormal conductivity of the natural gases examined in this investigation was due to the presence of an active emanation, similar in its properties to that from radium, was obtained from a series of observations on the radioactivity which the Brantford Gas was found to excite in all bodies placed in contact with it.

As with the emanation from crude petroleum, the excited radioactivity was mainly concentrated upon negatively charged wires and metallic rods immersed in the gas; but in this case uncharged substances, and even bodies charged positively, also became active when exposed to the gas.

In one set of the experiments, a brass rod carefully cleaned with emery was supported by an ebonite plug under various conditions of exposure, in a large galvanized iron tank filled with gas fresh from the well. Immediately after exposure, this rod was inserted as an exploring electrode in the testing cylinder *A*, Fig. 1, when filled with ordinary air, and a series of observations was made on the saturation current which its activity produced.

In Column I. of Table IX. the results are given when the rod was exposed in the gas for two hours under a negative potential of 10,000 volts, and in Column II. the results for a similar exposure in the same gas three days later. In Column III. the values of the saturation current produced by the rod after being exposed uncharged for two hours in the gas, are recorded and in Column IV. the number obtained when the rod was exposed for two hours under a positive potential of 10,000 volts. The results given in Columns II., III. and IV. were all obtained on one day from exposures made in the same gas. All the results are represented graphically in Fig. 7.

In making these tests care was taken to remove all traces of activity from the exploring electrode before submitting it to a new exposure.

TABLE IX.

Column I. (negative exposure.)			Column II. (negative exposure.)		
Time.		Current.	Time.		Current.
Hours.	Minutes.	Arbitrary scale.	Hours.	Minutes.	Arbitrary scale.
....	0	657.5	0	294.6
....	5	602.5	12	242.8
....	15	552.0	20	228.5
....	25	488.2	36	182.5
....	15	288.4	56	138.3
1	55	100.8	80	77.5
2	40	44.6
3	25	32.7

Column III. (uncharged.)			Column IV. (positive exposure.)		
Time.		Current.	Time.		Current.
Hours.	Minutes.	Arbitrary scale.	Hours.	Minutes.	Arbitrary scale.
....	0	90	0	50
....	14	72.5	9	41.4
....	22	61.2	19	37.2
....	52	42.4	29	33.4
....	20	27.0	53	27.7
1	53	22.0	88	18.9
2	30	15.5

It is interesting to find that the initial excited activity given in Column II. is approximately one-half of that recorded in Column I. As stated above, the exposures were made three days apart in the same gas, and under precisely similar circumstances. In this period parallel experiments showed that the conductivity of the gas decreased by one half and that, therefore, the amount of emanation present in the exposing chamber during the first exposure was about twice that remaining in the gas when the second took place. This result leads to the conclusion that the amount of excited radioactivity produced in any case is directly proportional to the amount of emanation present, which is in accordance with the deductions of Rutherford¹⁵ and other investigators from their experiments with active emanations from radium and thorium.

As the numbers in Column IV show, a considerable amount of activity was concentrated upon the rod when positively electrified. In this exposure, the rod was connected to the positive terminal of a Toepler-Holtz machine with its negative joined to earth. The

15. Rutherford "Radioactivity," Chap. IX, p. 255.

polarity of the machine was examined from time to time during the experiment but no indication of the occurrence of a reversal was observed. The experiment was repeated upon a number of

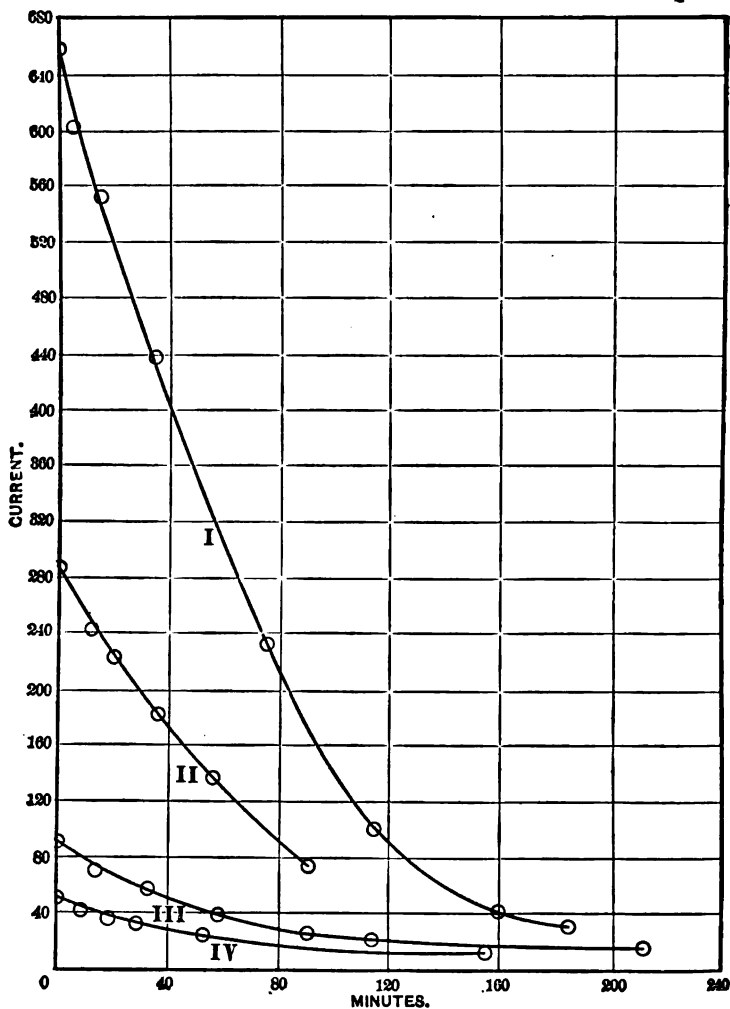

FIG. 7.

different occasions and the rod was always found to possess a small but well-marked activity after an exposure in the gas positively charged. The result was checked by exposing the rod positively

charged in a second receiver which contained only ordinary air, but in this test no trace of radioactivity was observed.

Allowing a deflection of 11 divisions per minute for the so-called "spontaneous ionization," it will be seen from the numbers given in Table IX. that the activity excited under positive exposure was about one-half that obtained with the uncharged rod and about 15 per cent of that obtained with negative electrification. A number of exposures made, first under negative electrification and then under positive, showed this ratio to be fairly constant.

The concentration of excited radioactivity upon positively charged conductors exposed in the open air has been observed on certain occasions by R. M. Stewart¹⁶ and by Elster and Geitel¹⁷, but in smaller proportions than the amounts found in this investigation. Rutherford also found that bodies positively charged in the presence of radium emanation became active, but the amount of activity produced upon the positive electrode in most cases was not more than 5 per cent of the corresponding amount when the body was negatively electrified. Up to the present time, no one seems to have observed any appreciable production of excited radioactivity on positively charged bodies exposed to the emanation from thorium.

The excited radioactivity obtained from natural gas, just as that obtained from other sources, decayed according to an exponential law and the rates of decay deduced from the numbers corresponding to the Curves I, II, III, and IV, Fig. VII, give 38, 44, 41 and 45 minutes respectively as the periods required by the activity to fall to half value. The mean of these values, which is 42 minutes, differs but slightly from the time, 40 minutes, required for the activity excited in wires exposed in the open air to die down to half value and one cannot but conclude from this result that the active emanation present in the atmosphere, and that in the natural gases investigated, are identical. It is also highly probable that much of the radioactive emanation which is present in the air in certain districts, finds its source in the numerous wells, which are steadily pouring out their contents at times in great volumes and under exceedingly high pressures.

It has been shown by Mme. Curie, Rutherford and others that the induced radioactivity from the radium emanation decays to one-half value in about thirty minutes, and Adams has found that the induced radioactivity from the gas in Cambridge tap-water falls

16. Stewart, *Trans. Canadian R. S.* Second series, 1902-3, p. 97.

17. Elster and Geitel, *Phys. Zeit.* 4 Jahrgang, No. 2, p. 97.

to half value in about thirty-five minutes. These values are of the same order as those determined in the present investigation, and lend support to the conclusion already arrived at that the active substance present in crude petroleum and in natural gas is very probably the same as the emanation from radium.

REMARKS.

On the assumption that the active emanation present in natural gas is produced from radium it is possible to form a rough estimate of the amount of the latter requisite to account for the conductivity observed. It has been found that the saturation current in air contained in a sealed vessel of 100 litres, due to the emanation from one gram of radium chloride, corresponds to a current of 2.5×10^{-5} electromagnetic units.¹⁶ Taking the charge on an ion as 1.1×10^{-20} electromagnetic units, this corresponds to a production of 2.3×10^{15} ions in the air per second. The highest conductivity observed in the present investigation was that obtained with the gas from the Brantford well. The conductivity in this case corresponded to the production in the gas of 1.5×10^4 ions per cubic centimetre per second and in 100 litres this would mean the production of 1.5×10^9 ions per second. It would therefore require the emanation present in 1.5×10^5 litres of the natural gas to obtain a conductivity equal to that which would be produced by the emanation from one gram of radium chloride. In other words every five million cubic feet of gas produced by the well would correspond to the existence of radium at its source, of approximately the amount contained in one gram of radium chloride.

The discovery of a natural gas so highly charged with a radioactive emanation as that observed in the present investigation presents a number of interesting features. It is possible that other natural gases still more highly charged may be found, and as it should not be difficult to concentrate the active constituent, additional light may be thrown by this means upon the various stages of the process of disintegration brought forward and developed by Rutherford and Soddy as an explanation of radioactivity.

The presence of nitrogen in such large proportions in the natural gases dealt with in the investigation should also not be overlooked. It is possible a portion of this gas, on closer examination, may prove to be helium, and if so, additional support will thereby be gained for the disintegration theory.

18. Rutherford "Radioactivity," Chap. XI, p. 370.

ON ELECTROSTRICTION.

BY PROF. LOUIS TRENCHARD MORE, *University of Cincinnati.*

By electrostriction is meant the strain in dielectrics, and their consequent mechanical deformation, produced by the passage of electricity through them. The action is supposed to take place in solid, liquid and gaseous non-conductors when they are electrified. The first observations date back to the beginning of the last century. In its early stages, electrostriction was looked upon as an isolated property of electricity, and, although laws were formulated, it was not until Faraday and Maxwell adduced the effect as one of the fundamental phenomena on which to build their new theory of ethereal stresses, that any considerable theoretical importance was attached to this property of electricity. That they did so regard it as one of the cornerstones of their theory is clearly shown by their own statements. Thus Faraday says (§ 1297): "The direct inductive force, which may be conceived to be exerted in lines between the two limiting and charged conducting surfaces, is accompanied by a lateral or transverse force equivalent to a dilatation or repulsion of these representative lines,"—and (§ 1224): "The attractive force which exists amongst the particles of the dielectric in the direction of the induction is accompanied by a repulsion or a diverging force in the transverse direction." Maxwell ("Electricity and Magnetism," Vol. I, p. 165), writes even more explicitly:—"The hypothesis that a state of stress of this kind exists in a fluid dielectric, such as air or turpentine, may at first sight appear at variance with the established principle that at any point in a fluid the pressures in all directions are equal. But in the deduction of this principle from a consideration of the mobility and equilibrium of the parts of the fluid it is taken for granted that no action such as that which we here suppose to take place along the lines of force exists in the fluid. The state of stress which we have been studying is perfectly consistent with the mobility and equilibrium of the fluid, for we have

seen that, if any portion of the fluid is devoid of electric charge, it experiences no resultant force from the stresses on its surface, however intense these may be. It is only when a portion of the fluid becomes charged that its equilibrium is disturbed by the stresses on its surface and we know that in this case it actually tends to move."

And as is well known he measures this stress by the famous formula $p = \frac{k V^2}{8 \pi d^2}$ where p is the numerical value of the tension, k the specific inductive capacity of the dielectric and V/d the fall of potential per unit length in the dielectric.

In support of this theory and equation a number of investigators have obtained both an expansion in the volume of an electrified glass thermometer and an elongation of a glass tube electrified radially, and have apparently made these deformations agree with the theoretical formula. When the mechanical is substituted for the electrical pressure, by the formula $F/S = p$, where $F/S = \mu \frac{\delta l}{l}$ we obtain $\frac{\delta l}{l} \times \frac{d^2}{V^2} = \frac{1 k}{\mu 8 \pi}$. The left-hand number is the expansion per unit length of a tube under unit electrical conditions. By taking the average of Cantone's results we get the value $\frac{\delta l}{l} \times \frac{d^2}{V^2} = 6.5 \times 10^{-13}$, when the best values for Young's modulus, μ and the dielectric constant for glass are substituted in the right-hand side of the equation there results a value of the same order but perhaps one-half as large. Quincke's average results are somewhat closer in agreement. This discrepancy is assumed to be due to the inadequacy of Maxwell's formula, which should contain an additional term, signifying the relation between mechanical and electrical pressures.

Passing over the cruder work of early writers, the best direct results were obtained by Quincke¹ and by Cantone.² In previous papers³ I attempted to show by their own results that both neglected to consider extraneous effects which were of the same magnitude as their recorded values and which would have, if introduced,

1. Quincke. *Wied. Ann.*, Bd. X, pp. 161, 374, 513; Bd. XIX, pp. 545, 705; Bd. XXVIII, p. 529; Bd. XXXII, p. 503.

2. Cantone. *Rend. d. R. Accad. Linc.*, t. IV, pp. 341; 471; *Rend. d. R. Inst. Lomb.* (2), t. XXXIII; *Nuovo Cim.* (4), t. XII, p. 150.

3. More. *Phil. Mag.* (5), vol. I, p. 198; (6), II, p. 527; (6), VI, p. 1; *Elect. World and Eng.*, vol. XLIII, p. 127.

accounted for the entire deformations observed. These errors are due chiefly to heating, lateral displacements, distortions caused by using thin tubes more or less irregular in diameter and thickness or by the lack of sphericity in any blown bulb. Quite recently Wüllner and Wien⁴ attacked the problem in an indirect manner, attempting to show that the elasticity of glass is greater when obtained by calculations from electrical stress than when found in the usual manner from acoustical or mechanical methods. It is interesting to note the contradictions of the different observers, these writers confirm Quincke's conclusions, though not his values, and condemn Cantone's and mine, while Sacerdote and Cantone consider Quincke's to be of no quantitative value. In the first place the measurement of the rise or fall of a capillary electrified water column, such as Wüllner and Wien use, is a mistake and their agreement with Quincke who often employed the same method is natural. I may add that this method is condemned by other investigators, Wüllner and Wien themselves noting the irregularities in the capillary rise of the water. These results show great variations in the value of the elasticity, measured mechanically and electrically, for different kinds of glass. For some glass the latter is not more than 1/2 of 1 per cent but for other kinds as much as 100 per cent greater. A variation of such magnitude due solely to small differences in the composition of glass is out of all proportion and certainly if electrifying glass more than doubles its usual elasticity such an elaborate method of experimentation was unnecessary. Lastly a variation in elasticity is directly contrary to theory. Lippmann, and his formulæ are shown by Sacerdote to be essentially in agreement with the other writers on the theory of this subject, states that the dilatation produced electrically must be due to a direct action of electricity *and cannot be caused by a variation of the coefficient of elasticity or, the coefficient of elasticity is independent of the electrification;* on the other hand the dielectric constant varies with the electrification.

Some years ago I published a paper in the *Philosophical Magazine* containing experiments whose results did not confirm the work of others and in fact made me doubt the existence of electrostriction. It was criticised by Sacerdote and Cantone on the ground that my method was faulty as they claimed I had em-

4. Wüllner and Wien. *Drude's Ann.* (4), Bd. IX, p. 1217.

ployed a mechanical instead of an optical device for magnifying the elongations and that it was not sufficiently delicate to observe the minute effect. The criticism was easy to meet and in a letter to the *Philosophical Magazine*, I demonstrated that my apparatus was an optical system, as sensitive or even a little more sensitive than interference methods and that their criticism of its lack of sensibility and accuracy was founded on a misinterpretation of some of my statements. Later investigations published in the same journal confirm my first results. Shearer⁵ is the only one since the publication of my work who agrees with me in my conclusions. Later in this article will be found new experiments which also strengthen me in my opinions.

Maxwell's formula, not agreeing with experimental observations, has been discussed by Korteweg,⁶ Lorberg,⁷ Kirchhoff,⁸ Lippmann,⁹ Sacerdote¹⁰ and others. Their methods may be divided into two categories, first, the determination of the attractions and repulsions of electrified conducting particles immersed in a non-conducting medium, or in other words, the results of a polarization of the dielectric, and secondly, the application of the thermodynamic equation and the interdependence of the laws of conservation of energy of matter and electricity. Sacerdote has made a careful synopsis of all the articles published on this subject with a critical discussion of methods and results. He finds that, barring small errors, both general methods lead to the same conclusion, which may be expressed by the formula $p = (k_1 + a) \frac{k V^2}{8 \pi d^2}$ where a is the inverse of Young's modulus and k_1 , the variation of the dielectric constant with mechanical pressure, represented by $\frac{\delta k}{\delta p}$. It is then Maxwell's equation with the addition of a second constant. This variation of the dielectric constant must be an exceedingly small quantity for of the few who have investigated it, some have obtained a positive value, some a negative and others a nul-effect. So that the pressure p may be increased, unaffected or diminished, possibly even eliminated by this quantity.

There seems to be a considerable degree of confusion prevalent

5. Shearer. *Phys. Rev.*, vol. XIV, p. 89.

6. Korteweg. *Wied. Ann.*, Bd. IX, p. 48.

7. Lorberg. *Wied. Ann.*, Bd. XXI, p. 300.

8. Kirchhoff. *Wied. Ann.*, Bd. XXIV, p. 52.

9. Lippmann. *Annal. de Chim. et de Phys.*, (5), t. XXIV, p. 159.

10. Sacerdote. *Thèse*.

in regard to the significance of electrostriction. It does not involve the pressure produced by the attraction of two charged bodies but is a property of electric flux in a non-conductor. For example two charged bodies attract each other and if they touch a solid dielectric, glass for instance, placed between them, the glass must be deformed mechanically whatever theory is adopted. But those who believe in electrostriction maintain that if the charged plates be separated from the glass and if the intervening spaces be filled with a fluid dielectric of the same dielectric constant as the glass and filled in such a way that the mechanical force of attraction of the electrified armatures cannot be communicated by the fluid to the glass, still the latter will contract in the direction of the lines of force and expand perpendicularly to them. This mechanical deformation, called electrostriction, is due then entirely to the electrical stresses in the ether communicated to the glass immersed in it. As an illustration we may make use of the system of glass and liquid dielectrics just described. The lines of electric flux in the ether stretch from one charged armature to the other and may experience the tensions and pressures generally ascribed to them. Since both the glass and the liquid have the same dielectric constant there is no discontinuity of these lines at the surface of the glass, yet it is supposed to contract in their direction. The only mechanical arrangement I can think of is to assume that each line does not extend from armature to armature but is like a chain linking particle to particle of the glass. Let us to be precise consider the action of a tension in one of these chain lines on three particles, one in the surface of the liquid adjoining the glass, a second in the surface of the glass and the third just within the surface of the glass. Since the dielectric constant is assumed to be the same in the two media, the pull on the middle particle is the same in both directions and there is no tendency to a displacement of the surface of the glass. This is also true for any three particles *in* the glass and contraction does not occur. Of course where there is a discontinuity of the lines, either in passing from one dielectric to another of a different inductive capacity or from a dielectric to a contiguous conductor, an unbalanced force exists, but that is merely the attraction of two charged bodies. If the lines of flux are supposed to pass through the glass without being attached to its particles it is difficult to see how the stress in the ether affects the glass.

If we assume Maxwell's formula for electric stress in the ether, and I know no other adequate, we must not lose sight of a most important fact, that theories involving the ether must always remain purely hypothetical as we have no possible method of experimenting upon it. And only when matter is immersed in the ether does experimentation become possible by the modifications produced in it. Now all our observation goes to show that for static and even kinetic phenomena, at least where the velocity is less than that of light, the ether is unmodified by matter and does not affect the properties of it; witness the absence of friction between the earth and ether in its motion about the sun, the baffling Kerr effect on the polarization of electrified transparent bodies, Brace's¹¹ experiments on the action of a magnetic field on transparent media showing that the Faraday stresses affect the velocity of light by an amount less than 2.0×10^{-14} for a c.g.s. unit of intensity per centimeter, and many others all supporting the doctrine of the independence of the ether and matter. My claim is then, not that Faraday stresses may not exist in the ether, but that these stresses are not transferred in any appreciable degree to matter as *unbalanced* mechanical forces. If this is true, the absence of the electrostrictive effect does not preclude the existence of ethereal stresses but, on the other hand, its presence would be a striking proof of Faraday's assumption of these lines of inductive force.

Sacerdote and the other writers on electrostriction claim that the connecting link between the ether and matter is expressed by the coefficient $k_1 = \frac{\delta k}{\delta f}$ or by the variation of the inductive capacity with mechanical pressure. In the first place, no such variation has been found experimentally as the results so far are discordant and subject to serious criticism. The question yet remains whether if it were found that k changes when a body is distorted mechanically, electrostriction necessarily exists. We know already that as a general rule this constant is least for gases, greater for liquids and greatest for solids, or it is dependent roughly on the density of the matter. We may then readily imagine that an increase in density caused by pressure will change the dielectric constant slightly, but the theorists maintain that this effect is due to a direct action of electricity and not to a variation of

11. Brace. *Phil. Mag.*, vol. XLIV, p. 349.

the coefficient of elasticity, as shown by my former quotation from Lippmann, Wüllner and Wien who alone regard the effect as being due to such a variation in elasticity have certainly mistaken the nature of the problem. Their results, as stated before, often show large variations, equal at times to the value of the whole coefficient of elasticity, in the elasticity of electrified and unelectrified glass. And though I believe that this difference is much exaggerated by errors of experimentation, still such a variation might exist in a less degree, but it would have no bearing on the subject of electrostriction. The question may then be put in this form, does a mechanical pressure (a stretching force which produces a decrease in density should theoretically increase the dielectric power) cause a variation in the mutual relations of the ether and matter. Such a relation has not been found experimentally and if it does not exist or if it is negligibly small, we must fall back on Maxwell's formula and so far at least observations do not verify it.

The apparatus used for the new experiments to be described is the same used before and the brief description of it is taken from my paper in the *Philosophical Magazine*.

A brass tube *A* (Fig. 1) was screwed into a heavy flanged iron collar and this to a wooden base. The experimental tubes were placed coaxially over this brass tube and cemented to a brass collar *C* at the base. The brass tube thus formed one armature and the experimental tube the dielectric of a condenser. For the other armature two devices served, either a sheet of tinfoil was pasted on the outer surface of the experimental tube, or a brass tube *F* capped with short glass tubes at the top and bottom, as shown in the figure. The brass tubes were seamless, quite straight and of uniform thickness. The experimental tubes were of different materials cast in a mold.

The dimensions of all these tubes will be given later.

The system of optical levers used to magnify the expansion of the tubes is shown in Fig. 2. An incandescent electric lamp with a ground glass globe was clamped behind a metal screen pierced with a round hole 5 mm in diameter. Across this opening fine platinum wires were fastened horizontally, to serve for the movable image. The light from the lamp, after reflexion at right angles by a totally-reflecting prism, passed through an achromatic lens to the mirror *m* mounted vertically on a little tripod table. Upon

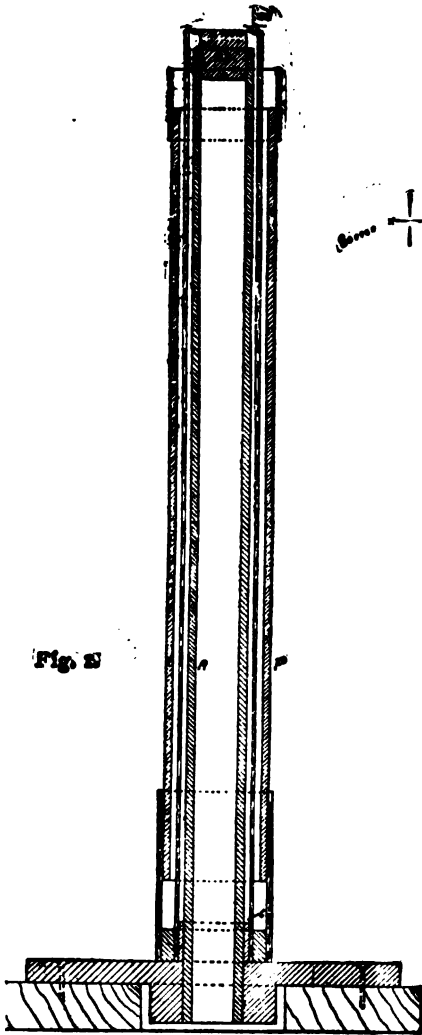

Fig. 1

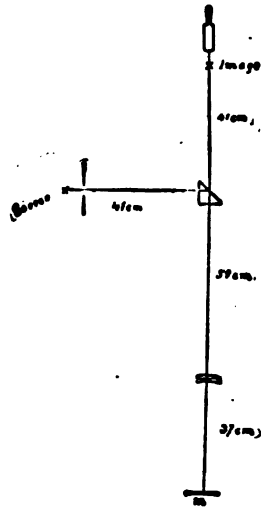

Fig. 2

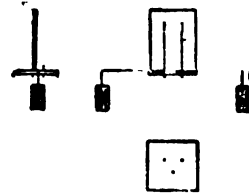

Fig. 3

reflexion from this mirror it again passed through the lens and on, above the prism, to a micrometer-microscope.

The mirror (Fig. 3), 1.5 cm x 2 cm, furnished by Brashear, was silvered on the front face and plane to $1/4 \lambda$. The tilting table of brass, 1.6 cm square, had three legs made of the finest needle points, one of which rested on the experimental tube and the other two on the brass cap *D*. By raising or lowering this cap, the beam of light could be reflected at any desired angle. Small weights which hung from an arm below the level of the table increased the stability to such a degree that the image showed no oscillation from outside disturbances. The prism and lens were both of the best construction, and the micrometer-microscope was a new instrument obtained especially for these experiments. The platinum wires and the microscope were each placed in the principal forms of the lens; the image of the wires was remarkably sharp and distinct.

By this arrangement, an elongation of the experimental tube caused the image of the fibres to fall in the microscope. The least change in length which can be observed is calculated from the following dimensions.

DIMENSIONS OF MAGNIFYING POWER.

Focal length of lens	100 cm
Distance between feet of tripod I.....	6 mm
Distance between feet of tripod II.....	3 mm
One division of micrometer on microscope.....	0.002 mm

A deflexion of one division of the micrometer, using tripod I, is equal to a change of length in the tube of

$$\frac{1}{2 \times 1000} \times 0.002 = 6 \times 10^{-6} \text{ mm.}$$

and with tripod II, 3×10^{-6} mm. This minimum deflexion could be observed readily. In compiling observations all readings were reduced to the basis of 6×10^{-6} mm for one division whichever tripod was used.

When electrically charged the inner armature and the tripod were grounded and the outer armature charged by a powerful static generator capable of giving an 8-in. spark of great volume. From one to four Leyden jars were placed in circuit to prevent irregularities in the charging. The potential differences were

measured by a spark-micrometer having balls 2 cm in diameter. With all the apparatus in the circuit the highest potentials could be reached in 10 or 15 seconds. When the tube was disconnected no disturbance reached the mirror when long sparks were passed across the terminals of the spark-micrometer.

The entire apparatus was fastened to heavy beams bolted to masonry piers in a basement-room. No experiments were made when the image showed changes due to variation in the temperature of the room during a period of time five or six times that of charging.

The apparatus was tested by determining Young's modulus for glass tubes and the results were consistent with each other and with the value of that constant.

Before discussing any new results I shall give a brief summary of my work with glass tubes. When the armatures are in contact with the glass a very rapid charge of 110 c.g.s. units, which required less than a quarter of a minute to attain, produces a small elongation but there is every reason for believing that it is produced by causes other than electrostriction. In the first place, the elongation depends on the manner and rapidity of charging, increasing with the length of time employed in obtaining the potential. Secondly the deflexion lags behind the potential and continues after the condenser is discharged. Both of these effects point to the influence of heat; in fact all observers state that the electrical action must be quick to avoid heating, but just what part is due to heat and what part to electricity none of them says: A simple calculation shows that a rise of temperature in the tube of 0.02 deg. C. would account for the entire deflexion. It is practically impossible to measure the heat developed in the glass, but an idea of the extreme delicacy of the experiment can be formed by the fact that if the hand is laid on the glass and *immediately* removed, the heat expands the tube much more than the electric charge.

A more accurate knowledge is obtained by measuring directly the rise of temperature of the surface of the glass. For this purpose a platinum-iron thermal element was attached to the surface and the tube charged a few times. The rise in temperature shown by the galvanometer varied from 0.4 deg. to 0.9 deg. C. for 10 chargings. There can be no doubt that such a rise of tem-

perature is amply sufficient to produce the entire observed elongation without ascribing it to a special property of electricity.

To this heating effect must be added the mechanical compression due to the charged armatures which were in contact with the glass. According to the value assumed for Poisson's ratio this effect is from a quarter to a third of the elongation.

The heating of the tube is due for the most part to discharges along the surface of the glass from the sharp edges of the tinfoil. If the armatures are separated from the dielectric and the intervening space filled with lard oil, these leakage currents are reduced in amount and the action on the glass is retarded. Besides this the effect of the mechanical compression of the armatures is reduced to a negligible quantity. With this arrangement of non-adherent armatures no effect which could be assigned to electrostriction was ever observed.

In a problem such as this, when the experiments contain extraneous effects, such as heating, etc., which act simultaneously and in the same direction as the true phenomenon, the question will be decided largely by accumulative evidence. I have for this reason undertaken a new series of observations on cylinders of paraffin, and of a compound of shellac.

A mixture of two parts by weight of Venice turpentine, four parts of shellac and one of resin, after being melted and cooled, was found to make a perfect casting and to be an excellent non-conductor. In character it was hard but neither very brittle nor spongy. Cylinders of this compound were cast in a mold made from two coaxial brass cylinders which were immersed in an oil bath kept at a temperature just below the melting point of the compound. Cylinders of pure paraffin were also cast in the same mold.

DIMENSIONS OF CYLINDERS.

Tube.	Composition.	Length.	Outer diam.	Inner diam.	Thickness.	μ	\bar{K}
7	Shellac	64.6 cm.	4.7 cm.	3.9 cm.	0.4 cm	1.2×10^{10}	3.5
9	Shellac	64.8	4.4	3.9	0.25	1.2×10^{10}	3.5
8	Paraffin	64.8	4.7	3.9	0.4	$< 10^{10}$	3.5

DIMENSIONS OF ARMATURES.

Inner cylinder, length, 64.8 cm; outer diameter, 3.7 cm; thickness, 3 mm.

Outer cylinder, length, 52.0 cm; inner diameter, 5.1 cm; thickness, 2 mm.

Space between armatures, 0.7 cm.

Length of tinfoil on each tube, 50 cm.

The values given for Young's modulus, μ , were obtained in the usual manner by placing weights on the end of the cylinder. They are fairly accurate for the shellac cylinders, but the compound is somewhat viscous and the action of the force is slow, so that 1.2×10^{10} is large for the elasticity. The value for the paraffin is less accurate and 10^{10} is certainly too high, as it is the modulus obtained from the instantaneous action of the force and the stresses of the electrical action always lasted at least a quarter of a minute.

Tube 7 was a little irregular in thickness, as it was somewhat distorted when taken from the mold. But the results are important as they show the marked effect of a slightly non-uniform field. Tube 9, after removal from the mold, was turned down in a lathe until it was perfectly uniform in shape and thickness.

TUBE 7 — ADHERENT ARMATURES.

Spark length.	Potential.	Mean elong. micr. div.	Mean elong. $\delta l \times 10^4 \text{ mm.}$	Time of charging.
5 cm.	60 c.g.s.	37.0	1.68	0.35 min.
7.5 "	85 "	35.0	2.10	0.35 "
7.5 "	85 "	70.0	4.20	1.00 "
10.0 "	100 "	55.0	3.30	0.25 "
10.0 "	100 "	100.0	6.00	1.00 "
10.0 "	100 "	180.0	10.80	5.00 "
12.0 "	110 "	133.5	8.01	0.35 "
12.0 "	110 "	243.5	14.55	1.00 "

The elongations, δl , are the mean in each case of a series of readings. Since one division of the micrometer equals 6×10^{-6} mm, the absolute value of the deflection is obtained by multiplying the observation in divisions of the micrometer by that number. The variations in each series of readings were not more than should be expected from the delicacy of the experiment and the irregularities in the conduction of the heat evolved.

In the first place, for the same time to charge, the elongation does not increase as the square of the potential. Secondly, the dependence of the deflection on the length of time used in charging the condenser is so pronounced as to make it imperative to account for it by the heat due to the action. When the condenser was discharged the return of the image, as Cantone also noticed, is quite irregular, at times the image returned quickly to the original zero, very often about half way, but most often there was no return. This is contrary to theory, as there should be no residual effect of the electricity.

TUBE 9 — ADHERENT ARMATURES.

Spark length.	Potential.	δl (mean) micr. div.	$\delta l \times 10^4$ mm.	Time.
5 mm.	60 c.g.s.	85.0	2.10	0.25 mm.
5 "	60 "	69.5	3.75	1.00 "
5 "	60 "	67.5	4.05	2.50 "
7.5 "	85 "	67.5	4.05	0.25 "

Greater potentials could not be used, as the tube was ruptured by a potential of 85 units.

According to theory the elongation varies inversely as the square of the thickness, thus for the same potential the ratio of deflections of tubes 7 and 9 should be 3 : 8. This is not verified, as the deflections for equal potentials and times of charging are about equal. In fact, the effect I ascribe to heating is so preponderant as to overshadow all others. Certainly the observations do not agree with the theory of electrostriction.

The tinfoil was then removed from tube 7, and the non-adherent brass-tube armatures were mounted in place. The space between the armatures and the dielectric was filled with pure lard oil, which has practically the same specific inductive capacity as the shellac compound. Thus the fall of potential between the armatures was uniform, and there was neither a free charge on the surface of the shellac tube nor any discontinuity in the lines of force. The elongation due to the mechanical compression of the charged armatures was eliminated, and, according to the value of Poisson's ratio taken, a decrease of from one-fourth to one-third of the deflection for adherent armatures of the same dimensions should result. Again, the distance between the armatures is now 7 mm, instead

of 4. which should theoretically reduce the deflection in the ratio of 16:49.

The results actually obtained are given in the following table:

TUBE 7 — NON-ADHERENT ARMATURES.

Spark length.	Potential.	δl (mean) micr. div.	$\delta l \times 10^4$ mm.	Time of charging.	Date.
10 mm.	100 c.g.s.	33.5	2.01	0.25 min.	Ap. 13.
10 "	100 "	64.5	3.87	0.25 "	" 14.
12 "	110 "	58.0	3.48	0.25 "	" 13.
12 "	110 "	80.5	4.88	0.25 "	" 14.
16 "	180 "	61.0	3.66	0.25 "	" 13.
16 "	180 "	98.5	5.91	2.00 "	" 13.
16 "	180 "	132.0	7.92	0.25 "	" 14.
16 "	180 "	170.0	10.20	2.00 "	" 14.

The table shows that the deflections, though somewhat less, are not nearly so small as they should be. Again, the influence of the duration of charging is evident. Lastly, the deflections are consistently different on the two days observations were taken; this I account for by the variation in the humidity of the room and its effect on the conducting power of the surface of the dielectric.

TUBE 8 — PARAFFIN WITH ADHERENT ARMATURES.

When experimenting with paraffin tubes the potentials were raised to an intensity which ruptured the tube. This occurred with a spark-length of 10 mm or 110 c.g.s. In no case were any deflections observed. I have not been able to account for this. Possibly, it may be due to the fact that paraffin is a homogeneous substance, while both glass and the shellac compound are highly heterogeneous, or it may be caused by resistance of paraffin to surface currents. After the tube had been charged and discharged, the image, as in all cases, showed a gradual elongation of the tube due to the heating. Paraffin is viscous and its action was probably slow and not very definite.

The results obtained with shellac and paraffin are not, I am sure, so reliable as those for glass. Tubes made of these substances bend easily and are liable to become distorted by extraneous static effects. They also distort gradually from day to day, and the discrepancies of the readings on different days and the uniformity of those taken on each day point to this. It is besides impossible to keep the tubes

from bending laterally when charged, and so altering their apparent length. But the results of these experiments do add to the evidence that the deflections observed may be fully accounted for without assigning the cause to electrostriction; certainly they do not confirm the theoretical laws which have been formulated.

The great objection to this form of experimenting is, of course, the fact that the effect perpendicular to the lines of force should be an expansion, and that an expansion in this direction is also produced by heating and mechanical causes. I have, for some time been designing an apparatus to measure the effect along the lines of force. As this should be a contraction, and as the effect due to heat is an expansion we should have a differential effect. The apparatus, as now designed, promises success, but unfortunately results for publication are not yet available.

THE UNOBTAINED WAVE LENGTHS BETWEEN THE LONGEST THERMAL AND THE SHORTEST ELECTRIC WAVES YET MEASURED.

BY PROF. E. F. NICHOLS, *Columbia University.*

We are accustomed to the use of two methods of producing transverse wave-trains in the ether: Molecular or atomic vibrations under the action of heat energy, and the oscillation of an electric charge on conductors of sensible mass at rest. It is doubtful whether the same wave frequencies will ever be obtained for direct comparison by both methods, nor is it any longer necessary to the electromagnetic theory that they should be, for nearly all known properties of light waves, except perhaps the magnetic rotation of the plane of polarization,¹ have been experimentally proved for electric waves, and certain properties first recognized in electric waves have been similarly established for waves excited by the agency of heat. Yet, if for no other reason than that of continuity, further effort to possess a part of the unexplored region between the longest thermal and the shortest electric waves would be well spent. After a brief survey of the limits of our present knowledge, several experiments directed toward the production and measurement of short electric waves are suggested.

PRESENT BOUNDARIES.

Growing out of the discovery of a region of metallic reflection in quartz² in the infra-red spectrum, a new method of isolating heat waves of great wave length by successive reflections from crystalline surfaces has been developed³ and by its aid the bounds of the known heat spectrum have been extended

1. A. Righi. *Beiblätter*, 1895, p. 357. Also A. Lampa, *Wiener Berichte*, 105, Ia, p. 1049, 1896.

2. E. F. Nichols. *Phys. Rev.*, 4, v. 297. Also *Wied. Ann.*, 60, p. 401, 1897.

3. H. Rubens and E. F. Nichols, *Phys. Rev.*, 4, p. 314, and 5, pp. 98 and 152; also *Wied. Ann.* 60, p. 418, 1897.

sixfold. After five reflections on sylvine surfaces waves 61μ in length have been isolated and measured.⁴ In character these longer waves already resemble electric waves more closely than they do light waves. All metallic surfaces reflect them about equally and almost totally.⁵ The necessary theoretical relations between reflecting power and electric conductivity⁶ and between refractive index and dielectric constant⁷ are more clearly manifested in them than in light waves. They can be polarized by gratings⁸ and it has been possible to demonstrate with conducting areas of suitable dimensions the same laws of resonance for heat waves which were known previously only for electric waves.⁹

It is, however, a question how much further the method of isolation by multiple reflection which has yielded so much can be carried. Several substances are known which according to the Ketteler-Helmholtz law should have regions of absorption and metallic reflection beyond 60μ ; but the difficulty of working beyond this limit is of another sort. Rubens¹⁰ has made computations from Wiens' law governing the distribution of energy in the spectrum of a black body at a temperature of 2000°C . The results show that the intensity of radiation at a wave length of 1.5μ is 800,000 times greater than at 60μ , and if the total energy between wave lengths 50μ and 60μ be taken as a unit, the total energy between 60μ and 100μ will be 0.7 and between 100μ and 1000μ about 0.2. While Wiens formula may not hold rigorously for very long waves, yet the outlook for a further extension of the known spectrum by this method is at least discouraging.

In the electric spectrum, beginning with Hertz 60-cm waves the wave length has been successively reduced by Righi, Lebedew¹¹ and Lampa.¹² Lampa with apparatus differing in no essential respect from the infra-red grating spectrometer, was able to obtain and make measurements with waves 4 mm long.

4. H. Rubens and E. Aschkinass, *Wied. Ann.*, 65, p. 241, 1899.

5. H. Rubens and E. F. Nichols, *l. c.*

6. E. Hagen and H. Rubens, *Phil. Mag.*, 38, p. 157, 1904.

7. H. Rubens and E. F. Nichols, *l. c.*; also H. Rubens and E. Aschkinass, *l. c.*

8. H. E. J. G. du Bois and H. Rubens, *Wied. Ann.* 49, p. 593, 1893; also H. Rubens and E. F. Nichols, *l. c.*

9. H. Rubens and E. F. Nichols, *l. c.* Electrical resonance also affords a possible explanation for certain peculiar phenomena observed in films of condensed sodium vapor in the visible spectrum by Prof. R. W. Wood.

10. H. Rubens. *Rapports au Congrès Internat. de Physique*, 2, p. 157. Paris, 1900.

11. Lebedew, *Wied. Ann.* Bd. 56, 1895.

12. A. Lampa, *l. c.*

Our present knowledge of the spectrum as a whole may be summed up in the terms of the wave frequency intervals familiar in music as follows: Beginning with Schumann's¹³ and Lyman's¹⁴ short ultra-violet waves of the order 0.1μ , we know about two octaves in the ultra violet, one in the visible and six in the infra-red spectrum making nine in all. Here the unknown region begins and the shortest electric waves yet obtained lie about six octaves lower in the scale.

POSSIBLE FUTURE EXPERIMENTS.

The conquest of the unexplored spectrum seems at present more hopeful from the electric than from the thermal side, as the difficulties encountered so far in the electric experiments are to some extent mechanical and depend less upon natural limitations. But to accomplish this extension new methods must be devised.

The short-wave electric experiments have so far been made with a vibrator, the thermal analogue of which corresponds theoretically to the isolation of a single molecule or atom forced to vibrate in a single plane. Limitations in the available quantity of energy with the diminishing capacity of the vibrator have not unnaturally been encountered and in all cases a form of radiation has been dealt with which is unknown to our optical experiments.

I hope sometime to undertake some experiments with a vibrator consisting of a very great number of small conducting spheres submerged in oil on the bottom of an insulating tray. Suitable electrodes will be introduced at the ends of the tray and the discharge from an induction coil driven either directly through the layer of spheres, or the equilibrium of the spheres disturbed inductively, while the tray is constantly agitated. If the spheres can thus be made to vibrate individually, the radiation from such a vibrator should be powerful and very complex because of necessity highly damped. The radiation would probably not be wholly plane polarized, for not only would the discharge follow a zig-zag path but spheres lying off the line of any one discharge would have their electrical equilibrium disturbed along diameters inclined to the direction of the main discharge. A radiation might, therefore, be expected not wholly different in character from the

13. V. Schumann, *Wiener Sitzungsberichte*, 102, pp. 415 and 625, 1893.

14. Theodore Lyman, *Astrophys. Jour.*, 19, p. 283, 1904.

emission of a very thin layer of a heated solid or liquid. It should be a continuous spectrum between broad limits, containing some shorter waves than the natural frequency of a single sphere acting independently. It is also not unthinkable that some interesting relations between the distribution of energy in this spectrum, could that be determined, and the energy of discharge, might be found. With some form of single-contact coherer similar to the one used by Herr Lampa combined with a transmission grating, it is possible that this spectrum could be explored and the distribution of its energy roughly determined. Herr Lampa's progress toward shorter waves was stayed by the difficulties of construction and failing energy of his single vibrator rather than from any lack in the receiver employed.

Of these selective and more strictly quantitative receivers the thermocouple introduced by Klemencic¹⁵ has been the one most

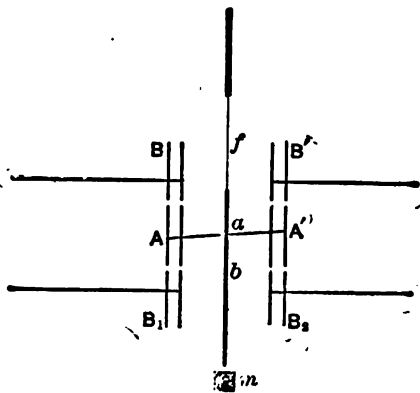

widely used, but I have the impression that the radiometric receiver due to Hull¹⁶ promises when perfected to be more sensitive. I want to mention one other possible form of receiver which, so far as I know, has not yet been tried — a receiver based on the electrostatic and electrodynamic action between equal resonators. The instrument would be essentially a torsion balance consisting of a rotation axis b , carrying a cross-arm a , and a mirror m , the whole system suspended by a fine fiber f , as shown in the accompanying diagram. Groups of resonators AA' , are to be fixed to the ends of the cross-

15. I. Klemencic, *Wiener Sitzungsberichte*, 99, IIa, p. 725, 1890.

16. G. F. Hull, *Science*, N. S., 16, p. 175. 1902.

arm a , and above and below these similar groups $B B_1 B' B_2$, mounted on fixed supports. The zero point of the balance should be chosen so that the plane of the suspended resonators will be turned through a small angle with the fixed plane of the other groups. Now if wave trains approach the system in a direction parallel to the cross-arm a , the resonator groups B, A and B_1 will always agree in phase and the phase of the groups B', A' and B_2 will likewise be in agreement with each other. Thus when the electric flux is a maximum, A will be magnetically attracted by $B B_1$, and a quarter period later when the electric displacement in the resonators is a maximum, the attraction will be electrostatic. In the interval between, the attraction will be both magnetic and static in changing proportions with the time. As similar conditions exist on the right of the figure there should be a constant moment to deflect the torsion system when exposed to waves of suitable length. The directive couple thus obtained may, however, be found so small that the receiver will not exceed in sensitiveness those already in use.

The foregoing suggestions are offered with all the uncertainty which must accompany ideas that have not been subjected to actual experiment, and they may be found wholly inadequate or even false, in practice.

THE MAGNETIC EFFECT OF MOVING CHARGES.

BY DR. HAROLD PENDER.

Maxwell, in his classic treatise on Electricity and Magnetism, makes the four following assumptions:

- 1.) An electric charge in motion produces a magnetic field.
- 2.) A varying electrostatic field produces a magnetic field.
- 3.) A magnetic pole in motion produces an electrostatic field.
- 4.) A varying magnetic field produces an electrostatic field.

Maxwell never attempted to test these conclusions experimentally — he considered them justified by the correctness of the conclusions to which his theory leads. This indirect method of verification is often the only possible means of testing the truth of an assumption. The greater the number of indirect tests the more probable does the assumption appear to express an actual fact, but absolute certainty can be attained only by direct experiment.

The great difficulty in the way of a direct verification of the above assumptions is that, in each case, at least one of the quantities involved is of such an order of magnitude, as to make its determination all but beyond the range of physical measurement. In fact, although it is now nearly 30 years since the publication of Maxwell's treatise, the first assumption only has been experimentally demonstrated, and that only after many years of patient research by a number of investigators. The second and fourth assumptions have also been submitted to experimental test, but up to the present they must still be considered doubtful, in so far as their truth depends upon direct verification.

In this paper I propose to consider briefly the experimental evidence we have in favor of the first assumption, to show how this evidence has been obtained, and to point out a few of the difficulties which have had to be overcome.

The original idea of a "convection current" is due to Faraday. In his *Experimental Researches*, Vol. I, art. 1644, he states that if a charged sphere should be set in motion in a space so large that the electrification of the sphere would be uninfluenced by any surround-

ing objects, there would be produced around the sphere a magnetic field. The first experiment, however, was performed by the late Prof. Rowland in 1876, in Berlin. The idea of his method occurred to him in 1868, before the publication of Maxwell's treatise, and is recorded in a note book of that date.

Briefly, Prof. Rowland's experiment was as follows: An ebonite disc with a gilded surface was caused to rotate about a vertical axis immediately beneath a metallic "condensing" plate connected to earth. Over the edge of the disc was suspended an astatic system.¹ When the disc was charged and discharged, or when the sign of the charge on the disc was reversed, the astatic system was observed to change its position of equilibrium. The deflection of the system remained permanent so long as the charge on the disc remained unchanged. Further, the deflection was in such a direction, and of such an order of magnitude, as to be accounted for by assuming 1) that the charge was carried around by the disc, and 2) that a charge so carried produces a magnetic field proportional to the speed of the disc and the surface-density of the charge carried. The maximum deflection observed by Prof. Rowland was 8 mm on a scale about 2 meters distant.

With various modifications in details, this experiment has been repeated by a number of investigators, and with one exception, all have obtained similar results.

Let us consider the orders of magnitude of the quantities involved. Suppose the disc is 30 cms in diameter, and that it revolves at the rate of 100 revolutions per second, between two condensing plates parallel to it at a distance of 1 cm each. Let the disc be charged to 10,000 volts, and the condensing plates be earthed. These figures represent the very best attainable conditions. Let us determine the quantity of charge carried per second past any fixed radial line, i. e., the strength of the convection current produced by the rotating disc.

The surface density of the charge on the disc is

$$\sigma = \frac{v}{4\pi d} = \frac{10,000}{300 \times 4\pi} = 2.65 \text{ c. g. s. units.}$$

The area of the disc is (both surfaces)

$$A = 2\pi r^2 = 2\pi \times 15^2 = 1414 \text{ sq. cms.}$$

1. In a metallic tube connected to earth.

Turns per second

$$n = 100.$$

Then the strength of the convection current will be

$$i = \frac{\sigma A n}{3 \times 10^{10}} = 1.25 \times 10^{-5} \text{ c. g. s. magnetic units}$$

or, roughly, 10^{-4} amperes.

The astatic needle cannot be placed closer to the disc than 1.5 cms. Assuming that a convection current produces the same magnetic action as a conduction current of the same intensity, what will be the strength of the magnetic field produced at this point? The accurate calculation of this is a long and tedious process, and can be found elsewhere. A moment's consideration, however, will show that only a very small ring of the disc near the periphery is effective — say a ring 3 cms wide. The intensity of the convection current produced by this ring is 4.5×10^{-6} c. g. s. units. This current flowing through a straight wire would produce a distance of 1.5 cms a magnetic field of strength

$$\frac{2i}{r} = 6 \times 10^{-6} \text{ c. g. s.}$$

lines per square centimetre. The field produced by this current distributed in a ring 3 cms wide will, of course, be considerably less, but it will be roughly of the same order of magnitude — 10^{-6} c. g. s. lines per square centimetre.

To detect such a field requires an astatic system of the greatest possible sensitiveness. But the great difficulty is not so much in devising the system, as in protecting this system from external disturbances. In the vicinity of any physical laboratory, especially in the large cities, there are innumerable sources of magnetic disturbances of a magnitude equal to, and, indeed, much greater than 10^{-6} c. g. s. units. In brief, to obtain satisfactory results with this method, the experiments must be carried on at a time when external disturbances are at a minimum, i. e., in the early morning hours; or the apparatus must be set up in the country at a considerable distance from any source of magnetic disturbance. Even then, a number of special precautions have to be taken. For example, unless the case in which the astatic system is suspended is kept at an absolutely constant temperature, the system will take up no constant position of equilibrium; for the system must be so extremely light that the slightest air current inside its case will cause a variation in its

equilibrium position for greater than the deflection which might be caused by the magnetic field to be measured. Again, the astatic system must be so mounted as to be free from all mechanical vibration. This is by no means easy to do, even when the apparatus is set up in a place where there are no external mechanical perturbations to contend with. Special precautions have to be taken to prevent the vibrations caused by the rapidly rotating disc from being transmitted to the system — a condition which requires extreme care to realize.

Without going into further details, it will suffice to say that when proper precautions are taken, Rowland's experiment gives results which are absolutely unquestionable; that is, there is no doubt that a charged metallic surface rotating opposite to a fixed condensing plate connected to earth does produce a magnetic field, and that this field is of the magnitude required by the above theory — at least to within 5 per cent.

In 1899, a new and extremely ingenious method of studying the magnetic action of a moving charged disc was devised by M. Cremieu. A flat coil of wire containing many turns is placed near the disc, coaxial with it, so that the magnetic field produced by the revolving charged disc will cut the coil. Any change in the charge on the disc will change the magnetic field around it, and consequently induce a current in the coil. A rapid charging and discharging of the disc while it is in motion will induce an alternating current in the coil. This current, even under the best possible conditions, will be exceedingly small — about 10^{-8} amperes — and of course cannot be managed directly as an alternating current. However, if this current is rectified by means of a commutating device driven in synchronism with the charging and discharging of the disc, a galvanometer can be used for its measurement. The galvanometer must be an extremely sensitive one — for satisfactory results, sensitive to 10^{-10} amperes. Its resistance may be either high or low, depending upon the resistance of the coil acted upon by the disc. A low-resistance coil and galvanometer are preferable.

The advantage of this method is that it permits the placing of the most delicate part of the apparatus — the magnetic detector, in this case a galvanometer — out of range of the mechanical and electrical disturbances set up by the rotating disc. Further, a galvanometer can be more perfectly shielded than a simple magnetometer from such external disturbances as stray magnetic fields or air-currents due to thermal conditions. The commutator, however, in-

roduces a weak point. Special care must be taken to eliminate any source of thermal e. m. f. at the contacts. Also, electrostatic effects must be suppressed by enclosing the coil and all parts of the galvanometer circuit in a metallic sheath connected to earth.

For two years Cremieu experimented with this method, but with results at the time absolutely inexplicable. The galvanometer failed to show even the smallest deflection, yet the calculated deflection was as much as 20 mm. He made modification after modification in the details of the apparatus, but his results were always negative as to the existence of a magnetic field around the moving charged disc. Not only were these results contradictory to Maxwell's theory, which had never yet failed, but they were also in direct opposition to the experiments of Rowland, Hutchinson, Roentgen, and Himstedt. Yet there was no doubt about the accuracy of Cremieu's observations. His experiments were frequently witnessed by such men as Poincaré, Pellat, Bouty, and other physicists of international reputation, but these men could discover no defect therein.

In the fall of 1900, the author, under the supervision of Prof. Rowland, undertook a repetition of these experiments, with the object of verifying their correctness, or of discovering wherein lay the cause of M. Cremieu's negative results. The apparatus employed differed in several details from that used by M. Cremieu, but at the time these differences appeared to be unessential. Yet from the moment that the apparatus was got into shape — and that was not until after several months had been spent in eliminating a hundred and one outside disturbances — there was never the slightest doubt that when the rotating discs were charged and discharged, a current was induced in the coil. Under the best conditions, a galvanometer deflection of 80 mm could be obtained.

These experiments were carried out in the physical laboratory of the Johns Hopkins University. Observations were taken only during the early morning hours, so as to avoid, as far as possible, the disturbing effects caused by the trolley and power lines which surround the laboratory. But even during the night it was impossible to make observations of any great accuracy. However, by the spring of 1901, sufficient data had been obtained to warrant the statement that charging and discharging a rapidly moving metallic surface near a fixed coil induces an electric current in that coil, and further, that this current is, at least approximately, of the order of magnitude demanded by Maxwell's theory.

These results were in direct opposition to those of M. Cremieu.

In the meantime, M. Cremieu had continued his experiments, but his results were always negative. The following year we both continued our researches, only to arrive at results even more contradictory — M. Cremieu's experiments always giving negative results, while those of the author, performed under much improved conditions, gave results agreeing remarkably closely with the effect as calculated.

Such was the state of affairs in the fall of 1902. The only hope of reconciling the contradictory results of the two experimenters seemed to be for them to work together. Through the kindness of Messrs. Poincaré and Bouty, and the generosity of the Institut de France and the Carnegie Institution in Washington, this desirable condition of affairs was brought about. During the winter of 1903, M. Cremieu and the author carried out conjointly in the physical laboratory of the Sorbonne, a series of experiments in which they located the cause of the discrepancies in their former experiments, and established beyond a doubt that a moving charged metallic surface produces a magnetic field. Further, they were led to the discovery of some new and complicated phenomena, which phenomena were the cause of M. Cremieu's failure to obtain any effect with his original apparatus.

Since the conclusion of their joint researches, the existence of a magnetic field around a moving charged disc has been further verified by experiments of Vasilescu-Carpen, Himstedt, and Eichenwald.

That a charged disc rotating opposite a fixed condensing plate produces a magnetic field may, therefore, be accepted as an indisputable experimental fact.

Let us now consider this phenomena in some detail. It is immediately evident that a moving charged disc is an essentially different phenomenon from a moving charged sphere, and is far more complex. In the case of the rotation of a charged uniform metallic surface, there are certain questions which must be answered before we can attribute the magnetic effect observed to an actual motion of the charge on the disc. In the first place, what justification have we for assuming that the charge is carried around by the disc? The conventional idea of lines of force would indeed suggest the contrary. Again, what role does the condensing plate play? If the charge on the disc moves, might we not also expect the charge induced on the condensing plate to move? In the case of a moving charged sphere no such questions arise. We have here an indisput-

able motion of a charge, unaffected in any way by surrounding bodies. This idea of Faraday's is one of extreme simplicity.

Of course it is out of the question to hope to measure the magnetic action of a single charged sphere moving in a space free from all other bodies. Such an ideal condition is far from even an approximate realization. It is absolutely essential to maintain the transportation of the charge past the magnetic detector practically continuous, for some seconds at least. It was with the idea of obtaining a continuous transportation of charge, that the early experimenters employed a disc with a uniform metallic surface rotating opposite a fixed condensing plate. But, as we have just seen, such an experiment involves other ideas than that of a simple motion of charge.

A much closer approach to Faraday's simple idea is found in an experiment performed by Adams in 1900. Adams' apparatus consisted of two sets of six spheres arranged in two parallel circles, so that the spheres were opposite each other in pairs, thus forming six condensers. If these spheres are charged and set in rapid rotation, the phenomena produced by their motion must be essentially of the same nature as the phenomena produced by the motion of a single charged sphere. If a single charged sphere moving past a point produces a pulse of magnetization at that point, then the motion of these two sets of spheres, one set charged positively and the other negatively, will produce at any point two simultaneous series of pulses of magnetization, one series positive and the other negative. The resultant effect will be a rapid succession of either positive or negative pulses, depending upon the relative position of the point and the two sets of spheres. An astatic system, with a comparatively long period, placed at the point, should then show a permanent deflection when the spheres are charged. This Adams found to be true, and measurement showed that, roughly, the effect was of the order of magnitude demanded by the theory.

However, the mechanical limitations of this experiment render it practically useless for accurate quantitative measurements. So once more we come back to the rotating disc and fixed condensing plates. From a mechanical standpoint, this arrangement is the ideal thing for the experiment, for the disc, when properly balanced, can be given a great velocity, and also the condensing plates serve as a screen to protect the magnetic detector, whether astatic system or coil, from the violent air currents caused by the rotation.

The disc found best suited for such experiments is one of micanite with its surfaces gilded. A solid disc cannot be used on account of the Foucault currents generated by its cutting the lines of force of the earth's field, and the magnetic disturbances caused by traces of iron in even the purest obtainable metal.

The importance of the question of the entrainment of the charge was appreciated by Rowland in his original experiment, and he endeavored to answer this question experimentally. Consider a plain circular ring MM , in the accompanying schematic diagram

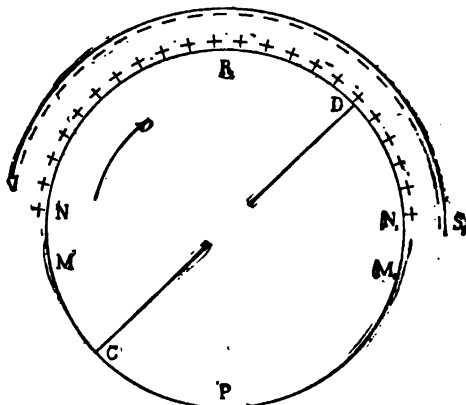

FIG. 1.

(Fig. 1), with a uniform metallic surface, rotating opposite a fixed condensing plate SS_1 , covering only a sector of this ring. Let the sector correspond to $1/n$ th in the circumference of the ring. Let the sector be charged and the ring earthed. Consider the ring rotating in the direction of the arrow. As each element of the ring comes under the point S , it will become charged by induction. If the element actually carries its charge along with it, the charge received under S will be carried around to S_1 . As the element passes out from under the point S , this charge, being no longer held on the element by induction, must return through the metallic surface of the ring to S . This will be true for all elements of the ring, and so there must be produced a constant difference of potential in the rotating ring between the points under S and S_1 . A conduction current will, therefore, flow in the ring between these two points. This current will flow in two paths N_1RN and N_1PN , dividing according to the relative resistances of N_1RN and N_1PN .

A magnetic needle placed above R will then be acted upon, first, by the convection current in the direction of the arrow, and second, by a conduction current in the opposite direction. A needle placed over P will be acted upon by a conduction current only, the direction being from N_1 to N . Moreover, the sum of the conduction currents must equal the convection current.

Rowland endeavored to detect these effects, but his apparatus was not sufficiently sensitive to give definite results. M. Cremieu and the author repeated this experiment in their joint investigation, giving $1/n$ the value $1/2$. They detected the effects without difficulty, and found them to agree with the values calculated as above to within ten per cent. Recently these results have been confirmed by Eichenwald.

However, by making a slight modification in the experiment, they were able to verify the entrainment of the charge with great precision. Consider the two points C and D diametrically opposite on the ring MM_1 . As the disc rotates, the difference of potential between these two points will vary according to a sine function, being a maximum when these two points are under the points SS_1 , of the fixed sector, and zero when the ring has turned 90 deg. farther on, and the points are in the position RP , and a maximum in the opposite direction when the ring has turned through 180 deg. An auxiliary circuit formed between R and P will, therefore, have set up in it an alternating current of an intensity depending upon the relative impedances of this circuit and the two circuits NRN_1 and NPN_1 .

From the two points C and D , leads were brought out through the axle of the disc. These leads were connected through special contacts, designed to avoid thermal effects, to a low resistance galvanometer. In the galvanometer circuit was placed an interrupter, actuated by the axle of the disc and so adjusted as to complete the circuit for only a half revolution of the disc. If the interrupter is set to complete the circuit while the diameter CD turns 180 deg. from the position RP , the galvanometer will receive a series of impulses of current, all in the same direction, and of a frequency equal to the number of turns per second of the ring. There should result then a steady deflection of the galvanometer.

In our experiments we were able to realize a convection current of 4×10^{-8} amperes. The resistance of each half of the rotating ring was 6 ohms. The galvanometer, which was of the movable

coil type, had a resistance of 4.38 ohms, and gave a millimeter deflection for a current of 10^{-7} amperes. The current through the galvanometer should then be 2.2×10^{-5} amperes, and the deflection 220 mm. The observed deflection agreed with this to within 2 per cent, which is as close as the constants which enter into the experiment can be measured.

This experiment too has recently been confirmed by Eichenwald. By substituting a telephone for the galvanometer and doing away with the interrupter, he was able to detect the alternating current in the ring by the sound produced in the telephone.

The evidence is then conclusive that the charge on a metallic surface rotating in its own plane, opposite a second mixed metallic surface connected to earth, is rigidly fixed to the surface and is carried around by it.

The next point to be considered is the action of the condensing plates. What is the condition of the charge on these plates when the disc is in motion? All experiments indicate that the condensing plate has no other action than the simple one of increasing the capacity of the disc. It might be supposed that the motion of the charge on the disc would cause a motion of the charge on the condensing plate. It would have to do so if, as is ordinarily assumed, a line of force is rigidly fixed to the charge at each end. Experiment, however, shows that this idea is untenable.

In the first place, we have the close agreement between the observed magnetic effect of the charged disc and the effect as calculated on the assumption that the charge on the condensing plate remains at rest. Further, Adams' experiments show that a fixed condensing plate is not an essential feature. Also, some recent experiments by Eichenwald, in which an entire condenser was rotated, indicate that only when the charged body is in actual motion does the charge on it produce a magnetic action.

A method of eliminating the condensing plates entirely, and one which comes very near being an experimental test of Faraday's simple idea, is the following, due to M. Cremieu. This method also possess the ingenious feature of making the convection current complete an otherwise "open" conduction current. The apparatus consists of a core of ebonite, 24 cms in diameter, carrying 18 sectors of gilded micanite, 13 cms long, separated from each other by 2 cms of air. The moving sectors *M* (Fig. 2) pass between two fixed charged sectors *S*, touching at the same time a brush *A* connected to earth. The sectors are thus charged by

induction. They then leave the brush *A* and the sectors *S* and pass under an astatic system *E*. Leaving *E*, they touch a second brush *B*, also connected to earth, by which they are discharged. By placing a galvanometer between *A* or *B* and the earth, one can measure the quantity of charge taken by the sectors when they are charged, or the quantity given up when they are discharged; or, to avoid circumlocution, the charging current or the discharging current. The astatic system is suspended in a metallic tube connected to earth. Between the tube and the moving sectors a sheet of ebonite is placed to prevent the sectors discharging to the tube.

For quantitative measurements this method possesses two disadvantages. First, it is impossible to calculate the distribution of

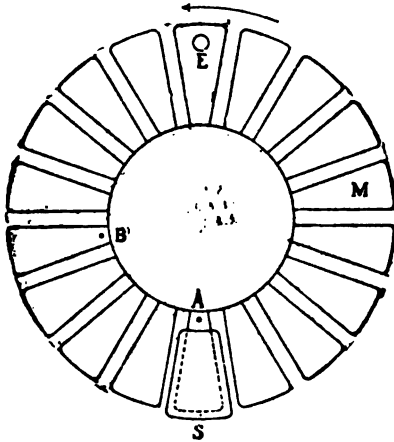

FIG. 2.

the charge on the sectors, and, therefore, the magnetic field produced at the astatic system. Second, it is impossible, with the sectors moving in the open air, to shield the tube containing the system from the violent air currents produced by the rotating sectors.

However, in spite of these difficulties, M. Cremieu and the author, in their joint researches, obtained readily the effect predicted by Faraday, which effect also agrees quantitatively, to a rough approximation, with that calculated.

We have now to account for M. Cremieu's inability, in his original experiments, to obtain any of these effects we have just de-

scribed. Let me call attention here to the fact that so far we have always spoken of a moving *metallic* surface. A simple metallic surface M. Cremieu never employed. To make the supposed effect as large as possible, M. Cremieu desired to obtain a large surface density of the charge on the disc. To prevent sparking between the disc and the condensing plates when a high difference of potential was established, he covered the disc with a thin coating of caoutchouc. In this apparently unessential detail lay the cause of the discrepancy between M. Cremieu's experiments and those of all the other investigators of this subject of electric convection.

A priori, there seems to be no reason why covering the charged surface with a dielectric should affect any possible magnetic action due to the motion of that surface. To explain this action of the dielectric is as difficult a problem as the original one of the motion of a charge. It is a problem which can be solved only by experiment. At present the problem still remains unsolved. The main facts that came out in our experiments in Paris are the following:

The experiment with the sectored disc just described was, with the exception that the sectors had a bare metallic surface, the same as that which had given M. Cremieu negative results. So, without making any other modification in the above experiment, we coated the sectors with caoutchouc. There resulted a decided diminution in the deflection of the astatic system, without, however, there being a corresponding change in the charge and discharge current measured by the galvanometer. Moreover, the character of the deviations of the astatic system changed. Decided at first for each of the two kinds of charge, the deviations rapidly diminished as the sign of the charge on the fixed sectors was reversed, and after a few reversals the deflection when the fixed sectors were charged positively became scarcely perceptible. For the negative charge the diminution was less.

Moreover, the charge and discharge currents presented anomalies. They no longer remained proportional to the potential of the charge on the fixed sectors when these sectors were charged to a potential higher than 2,000 volts. The currents were smaller than they should have been, and after a certain definite potential was reached, they remained practically constant, being unaffected by any further increase in voltage.

Returning to the continuous disc, we found a similar decrease in the magnetic effect when the disc was coated with caoutchouc. A sheet of paraffined mica placed over the surface produced even

more decided results. In one case the following deflections were observed:

Disc bare, condensing plates bare 140 mm.
 Disc covered with mica, condensing plates bare 100 mm.
 Disc and condensing plates both covered with mica..... 15 mm.

A satisfactory explanation of these facts is not yet at hand. It seems probable that the dielectric has a twofold action. First, a charge of opposite sign to that on the moving surface penetrates into the dielectric. Second, after a certain amount of charge has been absorbed, the dielectric seems to act as an electric screen, preventing any further induction across it. However, these are scarcely more than assumptions. They appeared to be justified by some further experiments performed by M. Cremieu and the author, but the whole subject is one of great complexity, and up to the present our knowledge of the facts themselves is but scanty.

Sutherland has recently put forward as an explanation of M. Cremieu's negative results the following: The experiments of Fizeau² and of Michelson and Morley³ on the velocity of light in running water show that the velocity is so modified as to be accounted for by assuming that the water carries along with it the ether at a velocity of $(1 - 1/\mu^2)$ times the velocity of the water, where μ is the index of refraction of the water. On Maxwell's theory $\mu^2 = K$, the dielectric constant, Sutherland assumes that the magnetic effect of a moving charge is due to the relative motion of the charge and the *immediately adjacent* ether, and that, as in the light experiment, the ether in the dielectric is carried along with a velocity of $(1 - 1/K)$ times the velocity of the dielectric. On this assumption, the dielectric covering the disc should reduce the magnetic effect by the factor $1/K$. However, this is by no means in quantitative agreement with Cremieu's experiments. Cremieu frequently obtained no effect at all, when the effect as calculated, even when reduced by this factor $1/K$, could have been readily detected. Further, this explanation is not in agreement with effects produced by a dielectric moving in a uniform electrostatic field.

When a slab of dielectric is placed in an electrostatic field, it becomes polarized, or, another way of saying the same thing, apparent charges are induced on the two surfaces of the slab. The question arises, will the motion of these apparent charges produce

² C. R., Vol. 33, p. 349, 1851.

³ *Sill. J.*, 3, Vol. 31, p. 377, 1886.

a magnetic field? Roentgen was the first to attempt an experimental answer to this question, and his experiments gave the answer in the affirmative. Roentgen's experiment has since been confirmed by the author, and recently also by Eichenwald.

Eichenwald has also devised an experiment in which the magnetic effect observed is the resultant of that due to the motion of a real charge and that due to the motion of an apparent charge. Consider a dielectric disc between the plates of a condenser. Let one plate of the condenser be earthed, the other charged to a potential V . Let the distance apart of the disc be d_0 , the thickness of the dielectric be d , and the dielectric constant of the disc be KH . Represent the electrostatic field in the air between the dielectric and the plates by H_0 , and the field in the dielectric by H . Then

$$V = Hd + H_0(d_0 - d).$$

At the edge of the dielectric

$$H_0 = KH.$$

The surface density of the apparent charge is by definition

$$\sigma^1 = \frac{+}{-} \frac{H - H_0}{4\pi}$$

whence, from the above relations

$$\sigma^1 = \frac{+}{-} \frac{K-1}{4\pi} \frac{V}{d + K(d_0 - d)}$$

Suppose that the dielectric fills up all the space between the plates of the condenser, i. e., that $d = d_0$. Then

$$\sigma^1 = \frac{+}{-} \frac{K-1}{4\pi} \frac{V}{d}.$$

The real charge on the plates of the condenser is

$$\sigma = \frac{+}{-} \frac{KV}{4\pi d}.$$

If now the whole condenser, both the dielectric and the plates, is set in motion, the convection current due to the motion of the real charge will be

$$i = \sigma A n = \frac{+}{-} K \frac{VA n}{4\pi d}.$$

(A = the area of the dielectric disc, and n = the number of turns per second.) The convection current due to the motion of the apparent charge will be

$$i^1 = \sigma^1 A n = \frac{+}{-} (K-1) \frac{VA n}{4\pi d}.$$

The resultant magnetic action will then be due to the sum of these two, i. e., to a convection current of strength

$$+ \frac{VAn}{4\pi d}.$$

In other words, if a condenser is rotated as a whole, the magnetic effect is independent of the dielectric between the plates of the condenser. This conclusion Eichenwald has verified with a close degree of approximation.

Sutherland's idea of a drag of the ether would lead to the same result in this case, provided the motion of the apparent charge was without magnetic effect. But this is contrary to Roentgen's experiment, in which the dielectric alone is in motion. Sutherland's hypothesis, then, does not account for all the facts.

One other point in conclusion. In the case of a charged metallic surface rotating opposite a fixed condensing plate, what happens to the lines of force? By definition, a line of force is something rigidly fixed to a charge at each end. J. J. Thomson, in his Recent Researches, has developed a theory in which he attributes the electromagnetic field around a conduction current to the motion of electrostatic lines of force through space. Evidently this idea is not applicable here. We have seen that the charge on the disc is in actual motion, while the charge on the condensing plate remains at rest, a state of affairs altogether inconsistent with the idea of a line of force as an actual tie binding the two charges at its ends together. Indeed, the best that can be said in the way of an "explanation" of the magnetic action of a uniform charged metallic disc is that the action is due solely to a relative motion of the charge and the ether, the ether both within and around the body remaining at rest.

BIBLIOGRAPHY.

- Faraday. "Exp. Res.," Vol. 1, art. 1644.
 Maxwell. "Elec. and Mag.," Vol. II, par. 770.
 Helmholtz. "Wiss. Abhandlungen, Vol. 1, p. 791.
 Rowland. *Am. Jour. Sci.* 3, Vol. XV, p. 30, 1878.
 Rowland and Hutchinson. *Phil. Mag.*, 5, Vol. 27, p. 445, 1889.
 Roentgen. *Sitzb. der Berl. Akad.*, p. 195, 1885.
 Lecher. *Rep. der Phys.*, Vol. XX, p. 151, 1884.
 Roentgen. *Sitzb. der Berl. Akad.*, p. 23, 1888.
 Himstedt. *Wied. Ann.*, Vol. XI, p. 93, 1890.
 Lodge. *Wied. Ann.*, Vol. XXXVIII, p. 560, 1889.
 Cremieu. *Phil. Mag.* 5, Vol. XXVII, p. 469, 1889.
 These de Paris, 1901.
C. R., Vol. 130, p. 1544.
C. R., Vol. 131, pp. 578, 797, 1900.
C. R., Vol. 132, pp. 327, 1108, 1901.
Ann. de Chem. et Phys. 7, Vol. 24, pp. 145, 299.
Jour. de Phys. 3, Vol. 10, p. 453, 1901.
Bull. de Soc. de Trans. Phys., p. 152, 1901.
Jour. de Phys. 4, Vol. 2, p. 753, 1902.
C. R., Vol. 135, p. 27, 1902.
 Pender. *Phys. Rev.*, Vol. 13, pp. 203, 325, 1901.
Phil. Mag. 6, Vol. 2, p. 179, 1901.
Phys. Rev., Vol. 15, p. 291, 1902.
Phil. Mag. 6, Vol. 5, p. 34, 1903.
 Nichols. *Phys. Rev.* 13, p. 60, 1901.
 Eichenwald. *Phys. Zeit.*, Vol. 2, p. 705, 1901.
Phys. Zeit., Vol. 3, p. 31, 1902.
Phys. Zeit., Vol. 4, p. 308, 1903.
 Whitehead. *Phys. Zeit.*, Vol. 4, p. 229, 1903.
 Adams. *Phil. Mag.* 6, Vol. 2, p. 285, 1901.
 Righi. *N. Cim.* 3, Vol. 2, p. 233, 1901.
 Civita. *An. Fac. Sci. de Toulouse*, 1901.
 Potier. *Ecl. Elec.*, Vol. 25, p. 352, 1901.
 Pocklington. *Phil. Mag.* 6, Vol. 1, p. 325, 1901.
 Wilson. *Phil. Mag.* 6, Vol. 2, p. 144, 1901.

- Cremieu.** *C. R.*, Vol. 135, p. 153, 1902; Vol. 136, p. 27, 1902.
- Poincaré.** *Ecl. Elec.*, Vol. 31, p. 83, 1902.
- Vasilesco-Carpen.** *Jour. de Phys.* 4, Vol. 2, p. 667, 1903.
- Cremieu and Pender.** *Jour. de Phys.* 4, Vol. 2, p. 641, 1903.
Phil. Mag. 6, Vol. 6, p. 442, 1903.
- Meyer.** *Jour. Franklin Inst.*, Vol. 156, p. 453, 1903.
- Himstedt.** *Ann. der Phys.* 4, Vol. 13, p. 100, 1903.
- Eichenwald.** *Ann. der Phys.* 4, Vol. 11, pp. 1, 421, 1903.
Ann. der Phys. 4, Vol. 15, p. 919, 1904.
- Sutherland.** *Phil. Mag.* 6, Vol. 7, p. 405, 1904.

TRANSACTIONS
OF
SECTION B
General Applications

Honorary Chairman, PROF. G. GRASSI

Chairman, Dr. C. P. STEINMETZ

Vice President, Mr. W. DUDELL

Secretary, PROF. SAMUEL SHELDON

[461]

TABLE OF CONTENTS—SECTION B

	PAGE
EDDIES AND HYSTERESIS IN IRON. By Mr. W. M. Mordey and Mr. A. G. Hansard	465
Discussion by Prof. C. P. Steinmetz, Prof. H. J. Ryan, Prof. A. H. Ford, Dr. C. H. Sharp, Prof. C. A. Adams and Mr. W. Duddell	469, 488
MAGNETIC VISCOSITY. By M. J. Jouaust	470
Discussion by Prof. C. P. Steinmetz	488
THE EQUIPMENT OF A COMMERCIAL TESTING LABORATORY. By Dr. C. H. Sharp	492
ELECTROLYTIC RECTIFIERS. By M. A. Nodon	510
Discussion by Prof. C. P. Steinmetz	526
TESTING OF ALTERNATING-CURRENT GENERATORS. By Mr. B. A. Behrend	528
Discussion by Prof. Harris J. Ryan, Mr. W. L. Waters, Mr. E. Kilburn Scott, Mr. D. B. Rushmore, Prof. C. P. Steinmetz and Prof. C. A. Adams	536
THE PREDETERMINATION OF PLUNGER ELECTROMAGNETS. By Prof. S. P. Thompson	542
INFLUENCE OF WAVE FORM ON THE RATE OF INTEGRATING INDUCTION METERS. By Prof. E. B. Rosa, Dr. M. G. Lloyd and Mr. C. E. Reid	555
Discussion by Mr. D. B. Rushmore, Dr. C. V. Drysdale, Mr. W. H. Bratt, Prof. G. A. Adams and Dr. Rosa	569
DESIGN OF HIGH-PRESSURE INSULATION. By Prof. H. J. Ryan	575
Discussion by Mr. D. B. Rushmore, Prof. C. A. Adams, Mr. E. Kilburn Scott and Prof. Ryan	588
ELECTRIC MOTORS IN SHOP SERVICE. By Mr. Charles Day	590
SINGLE-PHASE RAILWAY MOTORS. By Herr F. J. Eichberg	612
METHODS OF TESTING ALTERNATORS. By Prof. André Blondel	620
ARMATURE REACTIONS. By Prof. André Blondel	635
Discussion by Mr. D. B. Rushmore and Prof. V. Karapetoff	667
ON KINETIC VARIATIONS OF ELECTROMOTIVE FORCE IN DYNAMO-ELECTRIC GENERATORS AND ITS INFLUENCE ON THEIR WORKING IN PARALLEL. By M. Paul Boucherot	669
INFLUENCE OF HYSTERESIS ON THE WORKING OF ALTERNATORS IN PARALLEL. By M. Paul Boucherot	687
FLY-WHEEL ALTERNATORS. By M. Paul Boucherot	692
THE LEAKAGE REACTANCE OF INDUCTION MOTORS. By Prof. C. A. Adams	706
Discussion by Mr. D. B. Rushmore, Prof. V. Karapetoff, Prof. A. S. McAllister and Prof. Adams	724

THE REGULATION OF ALTERNATORS. By Mr. D. B. Rushmore.....	729
Discussion by Prof. C. A. Adams, Dr. C. V. Drysdale, and Mr. Rushmore	761
ON RECENT DEVELOPMENTS IN COMPOUNDED ALTERNATORS WITH ALTERNATING CURRENT EXCITATION. By Mr. Alexander Heyland..	762
Discussion by Mr. D. B. Rushmore, Prof. V. Karapetoff, Prof. C. A. Adams and Dr. C. V. Drysdale.....	790
A METHOD OF DESIGNING INDUCTION MOTORS. By Mr. H. M. Hobart...	783
Discussion by Mr. D. B. Rushmore.....	809
THE COMMUTATION OF DIRECT AND ALTERNATING CURRENTS. By Prof. E. Arnold and J. L. la Cour.....	801
<i>Total number of papers presented before Section B, 20.</i>	

Section B was called to order at 11.30 a. m., Monday, September 12, Prof. Charles Proteus Steinmetz presiding. •

CHAIRMAN STEINMETZ: Gentlemen, to complete the organization, I herewith nominate Mr. W. I. Slichter and Mr. D. B. Rushmore assistant secretaries.

The first papers on the programme deal with the magnetic characteristic of iron. As you know, in electrodynamic apparatus, that is, in nearly everything that revolves by electric currents, and in many stationary apparatus, the magnetic characteristic of iron is of fundamental importance, since iron is the magnetic material *per se*, and of special importance is that unfortunate feature of iron, that any change in its magnetic condition involves a loss of energy by hysteresis, and, also, where the rate of change is rapid, by eddy currents induced in the iron. Any paper dealing, therefore, with the energy relation taking place in iron in alternating-current fields is of importance and is gladly received. I therefore call on our Secretary to read Mr. Mordey's paper.

EDDIES AND HYSTERESIS IN IRON.

BY W. M. MORDEY AND A. G. HANSARD.

The object of this paper is to show the total losses in iron of different thicknesses, to emphasize the importance of eddies as a prime cause of waste, the need for good lamination, and to

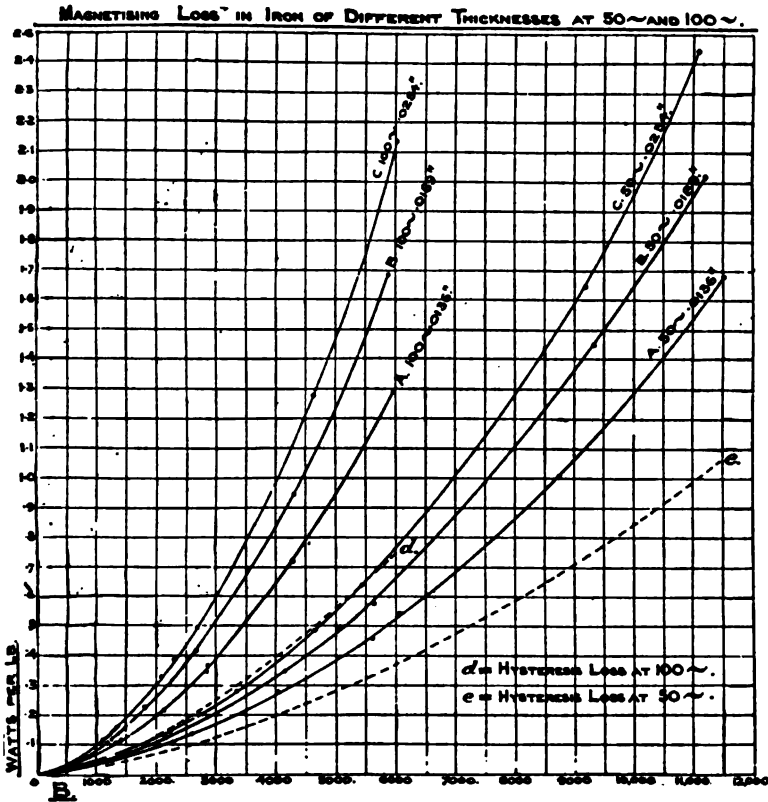

FIG. 1.

point out the results of observations of the form of total loss curves and their close resemblance to hysteresis curves. It is also

desired to show the need for making wattmeter tests of iron under working conditions rather than to place reliance on hysteresis tests alone.

Fig. 1 shows hysteresis and eddy current loss in three thicknesses of iron, viz., .0136 in. (.34 mm); .0189 in. (.47 mm); .0254 in. (.61 mm).

This iron was all of one make. It was tested in transformer form at 50 p.p.s. and 100 p.p.s., at magnetisations suitable for transformer work and to some extent for dynamo work. The tests were made on an alternator having practically a sine curve. The samples were large — nearly 12 lbs., each — the total energy loss being measured by a wattmeter. The hysteresis curves of this figure are based on a single test by a Ewing tester, for each sample, worked out for 50 and 100 p. by comparison with standards tested at 4000 B , 100 p. by ballistic galvanometer, other values of B being calculated on the Steinmetz $B^{1.6}$ ratio. The results need but little explanation to show the marked increase of loss with thickness. These tests do not lend any support to the common belief that with ordinary degrees of lamination the eddy current loss is reduced to negligible proportions. On the contrary, they show that the eddy loss is of the same order of importance as that due to hysteresis.

In calculating losses in iron from hysteresis tests, it is usual to assume that the rate of increase of eddy loss is proportional to the square of the thickness, the square of B , and the square of the periodicity. An examination of the curves will show that in some respects these assumptions are not confirmed, thus:

Thickness.—As between .0136 and .0189 in., the eddy loss on the average is practically proportional to (thickness)², but as between .0136 and .0254 in., the average increase is about 30 per cent less than the ratio of (thickness)², the increase being from 1 to about 2.4 instead of 1:3.5.

Eddies and B .—On the average, the increase is substantially in accordance with the B^2 assumption.

Eddies and Periods.—The increase is rather less than the usual (frequency)² assumption, being about 1:3.4 instead of 1:4.

The departures from the (thickness)² and (frequency)² ratios of increase may reasonably be explained by supposing the eddy circuits to have self-induction.

The six total loss curves will be found to be rather steeper than $B^{1.6}$ curves. It often happens, however, that the curves of

total loss are substantially $B^{1.6}$ curves, showing that the eddy constituent of the loss in such cases closely follows the Steinmetz hysteresis ratio.

Fig. 2 will illustrate this. It gives the total loss measured by wattmeter of iron .014 in. thick at 50 p. and 100 p., and at various B 's. The wattmeter readings are shown by round points, the points marked + being $B^{1.6}$ values.

This iron is representative of good transformer iron now ob-

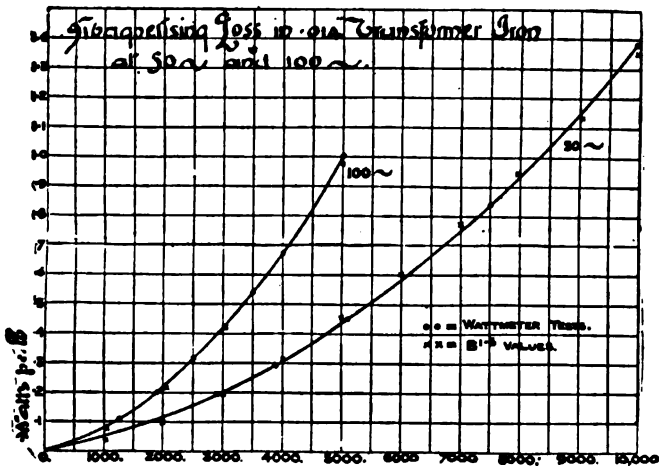

FIG. 2.

tainable in quantities in England. Slightly better iron is sometimes got, but not often nor in large quantities.

Fig. 3 shows the result of total loss tests by wattmeter of some .0124-in. iron at two temperatures, namely, 40 deg. F. and 167 deg. F., together with a ballistic-galvanometer test for hysteresis of the same iron taken at 2000, 5000, and 8000 B . The three hysteresis values so obtained fall on a $B^{1.6}$ curve. It will be found that the total loss curves (at the two very different temperatures mentioned) also follow $B^{1.6}$ curves, which are shown thus +, the wattmeter readings being shown by the round points.

Although the total loss generally closely approximates to $B^{1.6}$ curves, it may be either less or more steep than such curves. Fig. 1 shows examples of somewhat greater steepness; Figs. 2 and 3 show coincidence with $B^{1.6}$ curves, and the authors have also found curves less steep. Examples of the latter may be seen, e. g., in

the total loss tests given in Kapp's "Transformers" (1896, page 23), of iron carried up to nearly 7000 B , which will be found on examination to be less steep than a $B^{1.6}$ curve. The table of hysteresis values (going up to 15,000 B) given at page 108 of Ewing's "Magnetic Induction in Iron" (3d ed.), will also, on examination, be found to form a curve perceptibly less steep than $B^{1.6}$. As on the whole, however, the evidence is in favor of the Stein-

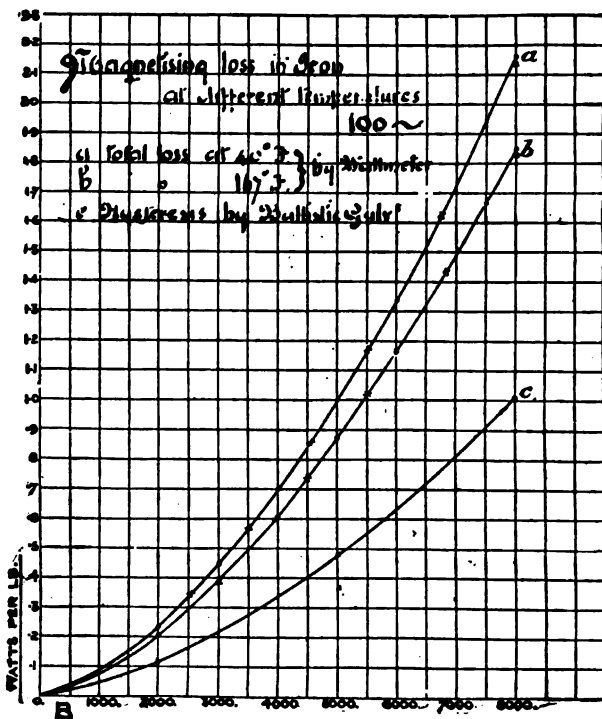

FIG. 3.

metz ratio for the hysteresis (though by no means invariably so), it is probable that the variations in the forms of the total loss curves are due to differences in the ratio of increase of the eddy currents. The various results point to the need for making wattmeter tests of total loss in iron under working conditions, and that it is not safe to rely only on hysteresis tests.

The iron used was supplied by Messrs. J. Sankey & Sons of Bilston, Staffordshire.

DISCUSSION.

CHAIRMAN STEINMETZ: I think I voice your sentiments in saying that this paper is very interesting in giving the results of tests of the losses in iron under varying conditions. The conclusions arrived at by the author are that the eddy-current loss is more considerable than is generally assumed, especially at the higher frequencies, as, for example, at one hundred cycles per second, and greater thicknesses of iron. Partly, indeed, this greater percentage of eddy-current loss may be due to a relatively low hysteresis loss due to the use of good iron. Now, I have this morning looked over the hysteresis curve, in trying to determine the coefficient of hysteresis, and I found $\int = 1.1 \times 10^{-3}$, which is a very low coefficient. This value is not very accurate, since I had no tables, and therefore had to estimate the logarithms. It is interesting in this paper to observe the variation of eddy-current loss with different frequencies, different thicknesses, etc., the effect of magnetic screening, that is, of unequal magnetic distribution throughout the laminae, which results in lesser increase of eddy-current losses than proportionately to the square of the thickness, and to the square of the frequency; and it is also interesting to observe the effect of the high temperature-coefficient of iron in the relative proportion of the loss at low and at high temperature, and possibly also the falling off of the eddy-current loss with increasing flux-density and thereby increasing temperature.

Before we start with the discussion of the paper, I think it would be well to read the second paper, which deals with similar topics, and I therefore call on the assistant secretary, Mr. W. I. Slichter, to give an abstract of Mr. Jouaust's paper on "Magnetic Viscosity."

THE PHENOMENA OF MAGNETIC VISCOSITY IN STEEL USED FOR INDUSTRIAL PURPOSES, AND THEIR INFLUENCE ON METHODS OF MEASUREMENT.¹

BY M. R. JOUAUST.

The phenomena of viscosity or of magnetic lag have been known to physicists for a considerable time. Ewing² first pointed out the fact that in weak magnetic fields soft iron is not immediately magnetized to a degree corresponding to the magnetic force to which it is subjected. Klemencic³ has studied this phenomenon with soft iron wires, and even with steel wires in magnetic fields, going as high as 1.6 gauss. This physicist employed the magnetometric method, and noted deviation of the suspended system four seconds, and also one minute, after the magnetic field was established. He observed that the absolute value of the phenomenon (the difference between these two deviations) increased with the field intensity, but that its relative value (the ratio of the difference between the two deviations to that existing at the end of one minute) decreased toward zero. The phenomenon was less intense in fine than in coarse wires. Fromme⁴ who has also studied this phenomenon on wires, and by the magnetometric method, observed that if soft iron was subjected to weak fields, it passed through a hysteretic cycle. The phenomenon of magnetic viscosity made itself apparent at all points of this cycle, or, in other words, in the case of soft iron, and in feeble magnetic fields, the change of magnetization corresponding to any given change in the magnetic field is not produced instantaneously.

More recently Wilson⁵ has had occasion to observe this phenomenon under conditions more or less identical with those under

1. A research conducted in the Central Laboratory of Electricity, Paris.
2. Ewing. "Magnetism in Iron," p. 122.
3. Klemencic. *Wied. Ann.*, Vol. LXII, page 68 and Vol. LXIII, page 61.
4. Fromme. *Wied. Ann.* Vol. LXV, page 41.
5. Wilson. *London Electrical Review*, page 318, 1893.

which we ourselves have studied it. Wilson studying, by the ballistic method, a ring composed of almost pure iron, observed that if the magnetic field was suddenly changed from one extreme value to another (from + 9.24 to - 9.24 gauss), the variation of induction was instantaneous, but that if the field was shifted from + 9.24 to - 1.1 gauss (the latter being the value of the coercive force), deflections were obtained on the ballistic galvanometer by bringing it into the secondary circuit 10 seconds after the variation of the magnetic field had been produced.

All these phenomena have hitherto been studied only with very weak magnetic fields and with very soft iron.

The ring studied by Wilson contained only 0.1 per cent of manganese, 0.013 per cent of sulphur, and traces of carbon and silicon. The maximum value of the permeability was 5,480, which gave an induction of 9,100 for a field of 1.65 gauss. It seems, therefore, that this phenomenon has hitherto been considered as negligible in soft steels used for industrial purposes, and in the conditions under which they are usually studied. Almost all conclusions regarding permeability and hysteresis of these steels are arrived at by applying the ballistic method to fairly massive test pieces. To our knowledge none of the experimenters studying the problem have seemed to guard against the causes of error which must necessarily arise with employment of the ballistic method, in the time necessary for the variation of magnetization, a time which in certain cases might be far from negligible with respect to the period of oscillation of the galvanometer needle employed. But the investigations of this subject, undertaken in the Central Laboratory of Electricity at Paris, seem to show that nearly all the very soft steels, which manufacturers have at last succeeded in providing for electricians, present this phenomenon in a sufficiently marked degree to cause the experiments carried on by the ballistic method upon solid test pieces made from these steels, to be subject to grave errors. We believe, therefore, that it may not be without interest to furnish some data of the principal results obtained in these investigations.

The study which we have undertaken in the investigation of this subject was mainly conducted on two rings of soft cast steel derived from the same pouring. One, ring *A*, had the following dimensions: Outer diameter, 147 mm; inner diameter, 107 mm; height, 25 mm. Ring *B* had as its dimensions: Outer diameter, 147 mm; inner diameter, 127 mm; height, 30 mm.

The steel of which these rings were composed had the following constitution: Carbon, 0.13 per cent; silicon, 0.09 per cent; sulphur, 0.04 per cent; manganese, 0.5 per cent.

This steel had been annealed at 900 deg. C.

The best method by which to study magnetic viscosity is undoubtedly the magnetometric method, but as this process can not be applied to test pieces of this form, we have employed the method utilized by Wilson, which consists in proceeding as if the ring were to be studied by the ballistic method, but only inserting the galvanometer in circuit a determinate and varied interval of time after the change in the magnetizing force has been produced.

The ballistic galvanometer which we used in these experiments is of the Deprez-d'Arsonval type, constructed by Carpentier. Its period of double oscillation is about 8 seconds.

The apparatus used for inserting the ballistic galvanometer in the circuit consisted essentially of a pendulum which, at a determined point of its swing, closed the galvanometer circuit by means of a relay operating a switch placed in series with secondary winding of the ring. As will be seen by the results described below, this method seems to permit the progress of the phenomenon to be followed fairly well in the different cases.

The rings of soft annealed cast steel, which were employed in this experiment, had been prepared more than a month before the experiments began.

At the very outset of the test, each one of these rings was made to pass through two or three hysteretic cycles, and the magnetic field was made to vary between ± 90 gauss (which corresponds to an induction of 17,000 gausses or thereabouts).

It was then observed in the case of the two rings, that if the magnetic force was suddenly varied from its maximum value to 0, it was possible to put the ballistic galvanometer in circuit a considerable time after this change, and still obtain a deflection. The following are the results obtained for the two rings with the ballistic galvanometer in both cases, with the same conditions as to damping (closed on a total resistance of 1000 ohms):

RING A.		RING B.	
Time seconds.	Deflection, mm.	Time, seconds.	Deflection, mm.
0	250	0	167
1	60	1	57
2	31	2	24
3	16.5	3	15
4	9	4	6
5	5	5	4.5
6	1.5	6	2.7

As may be seen, the phenomenon is very marked in both rings, and seems even more marked in the thin ring than in the thick one.

These phenomena are certainly due to magnetic viscosity, and can not be attributed to the action of induced currents. The latter might, indeed, give rise to analogous results, but the duration of the action observed would be much less. If we refer to the numerical results obtained by Hopkinson⁶ in his study of the action of induced currents, we see that the maximum lag produced by these currents would be 0.4 seconds, while we observed that the ring did not reach its final magnetization until after 6 seconds had elapsed.

When, on the contrary, the maximum magnetizing force was suddenly applied, it was found that the magnetization was immediately produced, and that, however quickly the ballistic galvanometer might be placed in circuit, after the variation of the magnetic field had been produced, no deflection was observed.

Thus it was clearly evident that the phenomenon of magnetic *viscosity* was presented.

These experiments were continued a week later, the two rings in the interim, having been subjected to repeated magnetizations. A notable diminution of the phenomenon was observed. In the case of ring *B*, the phenomenon became imperceptible after a lapse of two seconds, but remained more intense in the case of ring *A*, although here showing a marked diminution. The fact that the phenomenon is more intense in the case of the thick ring than in that of the thin one, is entirely in accord with the results of

6. Hopkinson. *Proceed. Royal Soc.*, Vol. LVI, page 108.

Klemencic; but the fact is, nevertheless, seemingly at variance with his results.

According to Klemencic and Fromme, repeated magnetizations have no influence upon the intensity of the phenomena of viscosity. Now, it is true that after this second experiment, in spite of numerous and repeated magnetizations, it was not possible to observe any further weakening in the phenomena. The falling off in the second series can only be attributed, therefore, to magnetizations of a steel which had never been previously magnetized. The considerable diminutions of viscosity, which were observed, could not be attributed to an effect of age. This would hardly account for a phenomenon produced in less than three days in steel which had been annealed for more than a month and which has since shown itself so constant.⁷

The study of viscosity undertaken after these two experiments bore upon two points, namely:

- 1). The study of viscosity for different points of a cycle of hysteresis, the extreme values for which correspond to saturation.
- 2). The study of magnetic viscosity for the different points of the theoretical curve of magnetization. (Summits of increasing cycles.)

I. STUDY OF MAGNETIC VISCOSITY AT DIFFERENT POINTS OF A CYCLE OF HYSTERESIS.

If in the case of ring *A*, a cycle of hysteresis is described between the values of the magnetizing force respectively equal to $H = \pm 98$ gauss (induction $\pm 17,100$) one observes that the phenomena of viscosity are feebly indicated at a magnetizing force of $+ 3.3$ gauss (induction 12,000). They increase little by little, become very intense when the magnetizing force is nil, continue to increase after the reversal of the magnetizing field, seem to present a maximum at a force close to the coercive force, and again become negligible at a magnetizing force of -8 gauss (induction $-11,800$).

7. This constancy is not perhaps in contradiction to the fact pointed out by Klemencic; namely, that the phenomenon of viscosity is very intense after annealing, and then decreases, as the ring studied had been annealed for some time. It may be noted however that we have observed the phenomenon in the case of steels which had been annealed several years before.

The curves of Fig. 1 relate to this phenomenon, and were obtained in the following manner: The magnetic field was suddenly changed from its maximum value of 98 gausscs to a weaker positive, null or negative value, and the deflections obtained on the ballistic galvanometer were noted, on placing this apparatus in

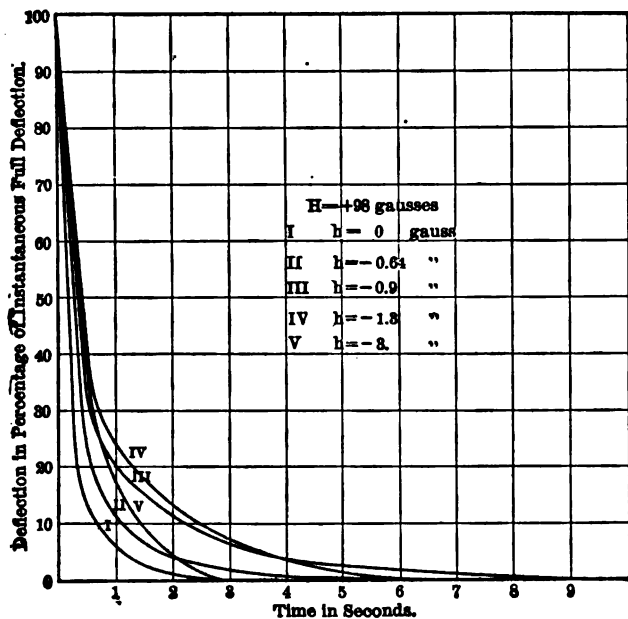

FIG. 1.

circuit, only for a certain time after suddenly producing the variation of the magnetic force. The ballistic galvanometer was, of course, subjected to the same conditions of damping in every case.

In these curves the abscissas are the time intervals, and the ordinates represent the deflections obtained in percentage of that obtained by leaving the ballistic galvanometer in circuit at the moment when the variation of the field was produced.

Table I sums up the data relative to these curves.

TABLE I.—DEFLECTIONS IN PER CENT OF PRIMITIVE ELONGATION.

TIME IN SECONDS.	0.	0.55.	1.05.	2.75.	3.85.	4.95.	6.	7.15.	8.25.	9.35.
For $h = 0$	100	12.5	2	0.8	0	0.	0	0	0	0
— 0.64.....	100	20	6	2	0.8	0.4	0.2	0	0	0
— 0.9	100	30	14	7	4	2.6	1.6	0.4	0.4	0.15
— 1.3	100	35	16	8.5	3.9	1.2	0.3	0.07	0	0
— 2.03.....	100	34	13	3.2	0.5	0	0	0	0	0
— 3	100	33	7	0.2	0	0	0	0	0	0

These results are perfectly definite. The experiments were repeated several times and the curves obtained are identical in size and shape. As may be seen from an examination of the preceding table, the duration of the phenomenon increases, from the moment the magnetic field is reserved, up to a value approximating—1 gauss, which is precisely the value of the coercive force. This result may easily be explained by assuming, with M. Maurain,⁸ that viscosity is due to the close vicinity of particular molecular magnets at a moment when their relative position is unstable, a condition which is obviously fulfilled at the moment when the reversal of magnetization is about to occur.

But it will be observed that although the phenomena of viscosity diminish rapidly in duration when the field h has become numerically greater than the coercive force, yet so far as concerns the first second of time following the variation of the field, they continue to increase in importance up to a value of h comprised between —1.3 and —2, in such a way that although, for instance, for $h = -0.64$, the duration of the phenomenon is about 7 seconds, the deflection after the lapse of a half second is only two-tenths of the initial complete deflection, yet it is about three-tenths and a half for $h = -2.03$; although in this case, the phenomenon has completely ceased after 5 seconds.

This fact should, in our opinion, be attributed to the action of induced currents. We have already seen that these currents may have an action analogous to that of viscosity, though of shorter

8. Maurain. *Éclairage Électrique*, Vol. XXXVII, page 42.

duration. We know, moreover, from the investigations of Hopkinson, that the action of these currents is at its maximum at the moment when the magnetization which tends to develop in iron corresponds to the maximum of permeability.

We see by examination of the cycle of hysteresis that precisely for values of the magnetic field comprised between -1.3 and -2 gaussess, the steel should be in a condition analogous to that of maximum permeability. The increase of the phenomenon in this condition during the first instants following the variation of the field may then, as it seems, be attributed to induced currents which superimpose their action upon that of viscosity, or, with more probability, to a reactive influence of these currents upon the phenomenon of viscosity.

The phenomenon of viscosity is observed, as has already been mentioned, even in the case of positive values of h . It is then very weak for $h = +0.9$, and completely ceases after a lapse of 2.75 seconds; while for $h = +0.64$ the deflection is only 0.15 per cent of the original deflection of reversal.

There is another means of causing viscosity to appear at a point in a cycle of hysteresis. If the magnetizing field is suddenly changed from its value $+H$ to a value h , then, generally as the result of viscosity, the deflection δ read on the ballistic galvanometer is weaker than that which should have appeared in conformity with the variation of the flux which has been produced. And indeed, if, after having waited a few moments, the magnetizing field is varied from h to $-H$, one observes a deflection δ_2 such that $\delta + \delta_2$ is less than the deflection Δ , observed in passing from $+H$ to $-H$. But if we shift the magnetic field from h to $+H$ (corresponding to a condition of saturation), as the phenomenon of lag is not produced, the deflection of δ_1 read on the ballistic galvanometer, is a good indication of the variation of flux which has taken place, and which is equal to that which should have been measured; in which case, we have, as might be expected, $\delta_1 + \delta_2 = \Delta$. We shall return to this process when we discuss the subject of methods of measurement, but we may note

at once that the ratio $\lambda = \frac{\delta_1 - \delta}{\delta}$ may serve as a means, with a given ballistic galvanometer, and under given conditions, to indicate the relative viscosity at a given point of a cycle.

Hitherto we have considered the case where a sudden variation

in the magnetizing field is brought about from its maximum value H , to another value h . It is interesting, in order to appreciate the value of certain methods of measurement, to observe what occurs if, instead of producing this variation all at once, we split it up into several successive steps. In Table II we give, in column I, the actual variations of flux produced; in column II, the variations estimated from the ballistic deflections when the variation is produced all at once, and in column III, when the process is divided up into about fifteen successive operations, the value of the maximum of the field being in both cases 98 gauss.

TABLE II.

H GAUSS.	I.	II.	III.
+1.1.....	8,000	7,700	7,650
+0.7.....	8,720	8,200	8,300
0.	10,500	9,600	9,850
-0.7.....	12,700	11,700	12,200
-1.1.....	17,850	12,650	14,750

As may be seen from an examination of the numbers in the two last columns, the differences obtained in both cases may be attributed to errors of observation and present no systematic variations.

Consequently, it seems that for all points at which the phenomenon of magnetic viscosity occurs, the total effect observed with sudden variation of the magnetizing field may be considered as the sum of the effects obtained at each one of the intermediary points, when the variation is produced by successive stages. A remark must, however, here be made in this connection.

In column I we have given the true variation of flux produced. But it is a well-known fact that, in general, this variation of flux is not the same in both cases, namely, when the variation of the magnetizing field has been produced all at once or through several successive steps.⁹ We may give an example of these variations. In the case of a ring composed of sheet iron, in which the phenomena of viscosity are relatively feeble, we obtain on the ballistic

⁹ Warburg "On Hysteresis." *Rapports*, Congress of Physics, 1900; Gumlich and Schmidt, *Elek. Zeit.*, 1893.

galvanometer, by varying the magnetizing field from its maximum value, 70 gausscs, to the value zero, the following deflections: In one step, 205; in three steps, 202; in eight steps, 199.

In the case of rings of soft steel, presenting the phenomenon of viscosity, on the contrary, the variation of flux is the same, whatever the mode of varying the magnetizing field may be. There is nothing surprising in this. The marked variations given above in the value of remanent magnetism, and depending on the manner in which the magnetizing field has been made to vary, come under the general case of abnormal magnetic phenomena. In the case of the sheet iron, we may observe that in consequence of the impulse received at the time of the sudden variation of the magnetizing field, the individual molecular magnets whose movement is not damped pass beyond their position of equilibrium, and as the latter does not correspond to a state of stable equilibrium, they do not exactly return thereto. In the case of the steels with which we are concerned, the movement effected by the aggregation of all the individual magnets is, on the contrary, a damped movement, and by all modes of motion they all arrive at the same final position of equilibrium.

INFLUENCE OF THE THICKNESS OF THE RING.

As we have already pointed out, except for the first experiments, the phenomena of viscosity were found to be less for Ring B, which has only 1 cm thickness, than for Ring A, which has 2. Table III sums up the results obtained from this ring under the same conditions as those which served to determine the values contained in Table I.

TABLE III.—DEFLECTIONS IN PER CENT OF ORIGINAL DEFLECTION OF COMPLETE REVERSAL.
H maximum = 100 gausscs.

TIME IN SECONDS.	0.	0.55.	1.65.	2.75.	3.85.	4.95.	6.
$h = 0$	100	2.7	0	0	0	0	0
$h = 0.8$	100	6	0.9	0.15	0	0	0
$h = 1.2$	100	18	4	0.7	0.25	0	0
$h = 1.7$	100	20	1.2	0	0	0	0
$h = 2.4$	100	13	0	0	0	0	0
$h = 3.6$	100	6	0	0	0	0	0

It may be interesting to compare for both rings, *A* and *B*, the values of the ratio designated above as λ .

We obtain then the following results:

	Ring <i>A</i> .	Ring <i>B</i> .
$h = 0$ gauss	0.055	0.03
0.7	0.13	0.06
0.98	0.23	0.11
1.3	0.93	0.07
2.2	0.17	0.03

We note that in the region comprised between $h = 0$, $h = -1$, i. e., so long as h is inferior to the coercive force, the value of λ for Ring *A* is approximately double its value for Ring *B*; the values of λ would be then approximately in proportion to the thickness of the rings. This is perhaps only a mere coincidence, to which it may seem expedient to call attention, but to which too much importance should not be attached, as the means which we have employed hardly lends itself to the investigation of quantitative results. At all events, as soon as h has passed beyond the value of the coercive force, the relation $\frac{\lambda_A}{\lambda_B}$ seems to increase. There is nothing strange in this, for we have seen that in this region induced currents seem to play an important part, and, moreover, the duration of the phenomenon becomes rapidly negligible in the thin ring as compared with the period of the ballistic galvanometer; so that our *modus operandi* becomes defective.

II. STUDY OF VISCOSITY AT A POINT OF THE THEORETICAL CURVE OF MAGNETIZATION.

If we seek to trace the theoretical curve of magnetization by noting apices of increasing cycles in the case of a steel which has been previously neutralized, we observe that if we suddenly pass from one extreme of the magnetizing field to the other it takes a certain length of time for the magnetization to assume its new value. The method of observing the phenomenon was the same as for the first part of this study, and consisted in observing the deflections of the ballistic galvanometer when placing this apparatus in circuit a certain time after the reversal of the field. To make this test, we bring the steel ring to a neutral state by pass-

ing it through successive cycles of magnetization of decreasing amplitude. This part of the operation should be made with the greatest care, for if the steel has not been brought into a neutral state, one would subsequently be led to describe not true cycles of hysteresis, symmetrical with respect to the representative point of the neutral state, but loops of no definite size or shape, and the phenomena of viscosity would not have the same intensity in passing from one such loop to another.

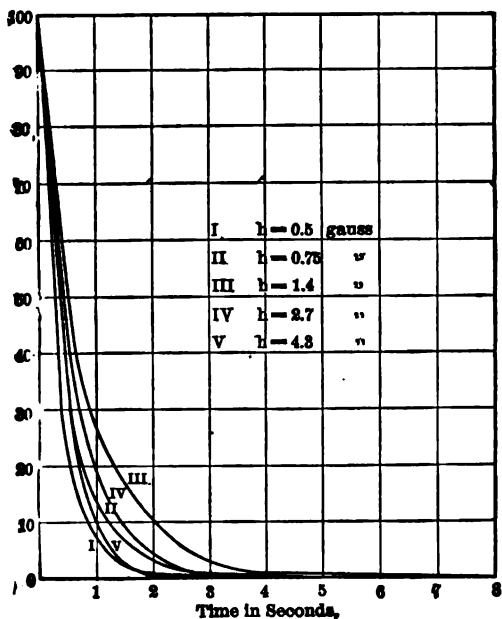

FIG. 2.

Warning is given of the fact that the ring has been imperfectly neutralized by observing that the deflection obtained on the ballistic galvanometer by reversing the current is not the same in both directions, a circumstance unquestionably due to the inequality of intensity of the phenomenon of viscosity.

Fig. 2 and Table IV give the results obtained from the test of Ring A.

TABLE IV.—DEFLECTION IN PER CENT OF PRIMITIVE DEFLECTION OF REVERSAL.

TIME IN SECONDS.	0.	0.55.	1.65.	2.75.	3.85.	4.95.	6.	7.75.
$h = 0.5$ $B = 1,250$	100	20	1.8	0.85	0	0	0	0
$h = 0.75$ $B = 2,500$	100	30	5.5	1	0.85	0	0	0
$h = 1.4$ $B = 4,000$	100	46	15.	4	0.75	0.2	0.1	0
$h = 2.7$ $B = 7,000$	100	88	7.7	0.6	0	0	0	0
$h = 4.3$ $B = 9,000$	100	80	1.5	0	0	0	0	0

As will be seen, the duration of the phenomenon of viscosity diminishes rapidly when the magnetizing field increases, starting from some specified value. As to its relative importance, it seems to present a maximum in values of the magnetic field of nearly 1.4 gauss. There is also present, undoubtedly, the influence of induced currents, for this value of 1.4 gauss of the magnetizing field corresponds exactly to the maximum of permeability, a maximum equal to 2,850.

Such are the principal results obtained in this study of magnetic viscosity made upon two rings of the same steel.

As already pointed out, almost all soft industrial steels now present this phenomenon in a fairly high degree, especially when test pieces of considerable thickness are tested. In the case of sheet iron, on the contrary, the phenomenon is relatively very feeble and can not be determined with the means that we have employed, save for a few points only of the cycle of magnetization and by selecting the conditions of maximum sensitiveness. This phenomenon, moreover, seems to be produced in all ferro-magnetic bodies in a manner more or less worthy of note. In the case of a cast-iron ring of 2 cms thickness, if one passes suddenly from a field of 90 gauss to a value close to the coercive force, one can, by putting the ballistic galvanometer in circuit 0.2 seconds after having produced the variation in the magnetizing field, obtain a deviation equal to about 1/100 of the initial deflection. We certainly have here to deal, then, with a phenomenon due to viscosity and not to induced currents, for as soon as one has gone beyond the value of the coercive force, the phenomenon ceases entirely.

At all events, if it was interesting to observe that the phenomenon of magnetic viscosity could be evidenced both in the case of

sheet-iron rings and of cast-iron rings of a certain thickness, it is especially important to remark that with test pieces of these substances, the phenomenon of viscosity can have no appreciable influence on the exactness of the ordinary measurements.

We may also notice an experiment in which we have sought for the action of an alternating field upon viscosity.

We know that Marconi originally attributed the operation of his magnetic wave-detector to an action of alternating currents upon viscosity.

Since then the experiments of Maurain have shown that we here have to deal principally with a diminution of ordinary hysteresis.

In order to see if there was not also an action upon viscosity, we have superposed upon the magnetizing winding of Ring A, a winding traversed by alternating currents of the frequency 42 cycles per second. The experiment thus carried out was, of course, a rough one, the action of alternative current being purely superficial, but we have obtained, nevertheless, a marked reduction of hysteresis.

Thus the action of alternating currents increased 5 per cent the deflection obtained by passing from the maximum field $+H$ to the intermediate value of h ; but the difference observed between this deflection and that read on the ballistic galvanometer in returning from h to $+H$ remained the same in both cases. It seems then that the action of an alternating current has no action upon viscosity, a result in complete accord with our ideas of the action of an alternating current upon magnetization.

Nevertheless, the experiment, for the reasons set forth above, is not, perhaps, very conclusive.

INFLUENCE OF THE PHENOMENA OF VISCOSITY UPON METHODS OF MEASUREMENTS.

We now reach the most important point of this inquiry, namely, the influence that the phenomena studied above may have upon methods of measurement.

Ballistic methods for the determination of the cycle of magnetization fall into two principal divisions.

The oldest method is that known under the name of the Rowland method.

The variations of the field are produced, starting from the maximum, by successive stages, and the deflections of the galvanometer

evaluate the variations in the flux corresponding to each one of these stages.

The sum of these variations enables us to ascertain the total variation of the flux when the magnetizing field passes from one extreme value to the other.

The other method developed by Ewing and Miss Helena Claassen in their researches on the law of Steinmetz consists in bringing the magnetizing field after each measure to its maximum value, and in measuring the variation of flux produced by shifting the field from this maximum value to another and a weaker absolute value, which may be positive, nil, or negative. This is the *modus operandi* which we have employed in all our investigations.

Often, instead of tracing a cycle of hysteresis, we trace the theoretical curve of magnetization to which we have already referred, which is done by causing the test ring to pass through magnetizing cycles of increasing amplitude, and by noting for each one of these cycles the variation of the flux obtained on shifting suddenly the magnetizing field from one extreme to the other.

Rowland's method has often been criticised with the fact that it lends itself to an accumulation of errors, so that many experimentors prefer Ewing's method in which this source of error is not to be feared.

As a matter of fact, we think that, for the study of test pieces in which the phenomena of viscosity are not to be feared, the two methods are of equal value, for the readings can readily be made upon the graduated scale of the ballistic galvanometer with a considerable degree of accuracy.

It is certain that every experimenter, however skilful he may be, is always liable to make gross errors in reading, and if he contented himself with a single observation, the first method might give him completely erroneous results, while in the second, the error would bear only on one point of the cycle. But a skilled experimenter would not content himself with a single reading and, consequently, any gross error could not escape him. From very numerous experiments carried on in person, we are able to conclude that Rowland's method gives very concordant results in measurements several times repeated.

Ewing's method is open to the objection of requiring rather complicated apparatus, and of necessitating in the course of the experiments a change of sensitiveness in the ballistic galvanometer.

As the current necessary to the production of the maximum field circulates for a much longer time in the magnetizing circuits, there finally results therefrom a certain amount of heat and subsequently a variation of resistance in the different parts of this circuit. The current varies and it is sometimes very difficult to compensate for this variation exactly.

But if from the point of view of the test rings in which the phenomena of viscosity are very weak, the two methods are of equal value, each having its own advantages and objections, it is not the same in those cases where the phenomena of viscosity are fairly intense. Neither of the methods is, in this case, rigorously exact.

As we have seen above, if we use the Rowland method, a great many of the readings of the ballistic galvanometer will be too low, in consequence of the time required for the magnetization to establish itself; half the sum of these readings from which the value of the induction corresponding to the maximum field is deduced will also be too low and only erroneous results will be obtained.

The same thing will happen, as is shown by Table IV, if the Ewing method is applied to cycles corresponding to weak inductions. But if the method is applied to cycles as above described, between values of the field corresponding to saturation, the results become more exact.

The results corresponding to the sections of the cycle near saturation are no longer spoiled by errors, and we have particularly the value of the induction corresponding to the maximum field with great exactness, and only the points of the cycle situated in regions where the variations of the induction are rapid show inexactness.

As far as the figure described by the theoretical curve of induction is concerned, we see that the ballistic method may also give results too low for values of induction inferior to 10,000 gausses.

Beyond this value the results become exact.

Fig. 3 shows the curves of cycles of hysteresis obtained by these different methods—Curve *I* applies to Ring *A* and to the Rowland method; Curve *II* to the same method, with Ring *B*; Curve *III* to Ring *A* and to Ewing's method.

It will be seen that by using this method we find for the steel tested an induction of 17,100 gausses for a magnetizing force of

98 gausses; while the Rowland method applied to the same ring leads one to admit for the same field an induction of 14,900—representing an error of 15 per cent. Ring *B*, in which the phenomena are less intense, in consequence of lesser thickness, gives a smaller error if studied by the Rowland method.

We find for a magnetic field of 100 gausses an induction of 16,000. The error here is only one of 6 per cent.

It seems then that in order to avoid experimental disappointments in the study of cast steel, it would be expedient to apply the Ewing method in the case of thin rings.

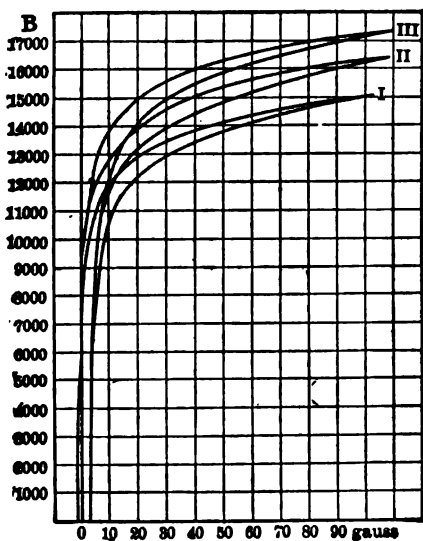

FIG. 3.

But there exists another means of precise determination of the cycle of hysteresis corresponding to a region of saturation and either with a thick or with a thin ring.

We have seen, indeed, above, that in cases of a cycle of saturation if the deflections read on the ballistic galvanometer when the magnetizing field is varied from $+H$ to h indicate inaccurately, as the result of viscosity, the variation of flux produced, this variation is, on the contrary, exactly represented by the deflection observed when one passes from h to $+H$.

It suffices then to apply to the Ewing method the slight modification consisting in making the readings in return to the maximum of magnetizing force, in order to have correct results in every case.

We give below the results obtained from Ring A by using both methods, results which make it possible to observe the order of the errors to which we are exposed by using the Ewing method as it is usually employed.

TABLE V.

Magnetizing Field Gausses.	Method of Ewing.	Induction Gausses, Ewing Method, Modified.
98	17,100	17,100
22	15,145	15,145
3.35	11,950	11,900
1.12	9,400	9,050
0.72	8,900	8,400
0	7,500	6,500
— 0.72	5,350	3,400
— 1.12	3,450	— 750
— 2.27	— 1,800	— 5,800
— 3.35	— 4,900	— 7,700
— 8.7	—11,200	—11,800
—22.	—14,500	—14,500
—35.	—15,300	—15,300
—98.	—17,100	—17,100

This modification of the Ewing method may, in our opinion, render great service in the study of cast steel. It should be noted that for this kind of steel it is easier for constructors to furnish as test pieces thick rings rather than thin, in the casting of which it is difficult to avoid cavities. It should also be noted that the curve described by a cycle of saturation is amply sufficient for the observation of the properties of these steels.

The theoretical curve of magnetization, a curve more closely approaching the rising than the descending branch of the cycle, gives the value of permeability which it is necessary to introduce into the calculation of machines and especially in the case of sheet iron employed in alternating flux apparatus; — but for cast steels intended to be used as field magnets and always to be magnetized in the same direction, the value of permeability to

be introduced into the calculations is less well defined and it is certainly more advisable to consider as the curve of magnetization a mean curve comprised between the descending and the rising branches of the cycle than the theoretical curve as defined above.

Moreover for these cast steels, it is well to have information not only upon the permeability of the metal; but also upon its coercive force, since a dynamo whose field magnets seem to be constructed with metal of too weak coercive force runs the risk of easily losing its magnetism.

The curve of the cycle of hysteresis with saturation seems then to furnish to the constructor all the data necessary to the construction of these machines and it is for that reason that we have thought it well to insist so long upon the procedure which promises the correct tracing thereof in each and every case.

DISCUSSION.

CHAIRMAN STEINMETZ: Mr. Jouaust's paper deals with a characteristic of the magnetic field much less familiar to us than the phenomena of magnetic hysteresis which we have to deal with in alternating-current engineering. It has been suspected, ever since the early days, that the hysteresis loss is dependent on the frequency with which the magnetism changes, and there is a time-lag of magnetism or a magnetic viscosity. But investigations made in alternating magnetic fields have failed to establish conclusively the existence of such a time-lag. At the same time, such a time-lag has been observed, and the paper here deals with it. The time, however, during which this phenomena occurs is large compared with the time of the period of even our slowest alternating currents, so that within the range of commercial frequencies, the hysteresis loss per cycle is a constant, and no time-lag, no magnetic viscosity, comes into consideration. Nevertheless, you can appreciate the engineering bearing of this magnetic viscosity or this time-lag by considering those cases where the magnetic circuit is exposed either to alternating or to direct magneto-motive forces. It means that the magnetic flux produced by an alternating current is less than the magnetic flux produced by a direct current of the same intensity, especially so in that range of the magnetic characteristic where it is less stable; that is, in the range of the characteristic where it is steepest. The engineering bearing of this you can see by considering, for instance, its influence on the speed characteristic of those modern electric railway motors which are designed to operate on alternating currents as well as on direct currents; or, by considering its influence on electric meters, in which the indication is given by the action of iron in the magnetizing field.

The discussion of the two papers of Mr. Mordey and Mr. Jouaust is now open. I call upon Prof. H. J. Ryan to give us his opinion, since Doctor Ryan was, as far as I know, one of the first, if not the first,

investigator, who observed the phenomena of hysteresis under practical engineering conditions, fifteen years ago, and described them in his Institute paper.

Prof. H. J. RYAN: While I am thankful for the kind invitation to discuss these interesting papers, I find that I have very little to offer in addition, or by way of discussion. It occurred to me, however, in listening to the paper of Mr. Mordey, that it would be very interesting and useful to have records of the wave-forms of the magnetic flux-densities which caused the losses measured by wattmeter in the samples of magnetic laminae.

Prof. A. H. FORD: The paper by Mr. Mordey calls to mind an interesting experiment performed at Columbia University some years ago to determine whether the hysteresis loss in an iron core varied with the speed of reversal of the magnetism.

A ring, composed of armature punchings having outer and inner diameters of about 40 cm and 30 cm respectively, built up to a height of 20 cm, had two coils wound upon it, one, the magnetizing coil, entirely covering it and the other, a test coil, covering a small section only. An e.m.f. of nearly sinusoidal wave-shape, having a frequency of 125 cycles per second, was applied to the magnetizing coil and the curves of current in the coil, and pressure across the test-coil, were plotted by the instantaneous-contact method. The hysteresis and eddy-current losses were then separated; the m.m.f. due to the eddy currents determined and subtracted from that due to the current in the magnetizing coil; giving the true m.m.f. curve. From the curve thus determined and the magnetization curve, determined from the pressure curve, the hysteresis loop was plotted. The hysteresis loop was then determined by the step-by-step method, using a ballistic galvanometer, taking perhaps ten minutes for completing the cycle. When the two curves were compared they were found to agree within about 3 per cent, which is within the limits of experimental error. Moreover, there was no rounding of the corners, when the cycle was passed through rapidly. The rounding mentioned by many experimenters is evidently due entirely to the effect of eddy currents.

Dr. C. H. SHARP: The paper by Mr. Mordey seems to me to point out the necessity for making tests of iron on samples of considerable size and by the wattmeter method. The eddy-current losses are so large that they become, as Mr. Mordey has shown, an important factor, amounting to about 50 per cent of the total, and in view of this fact it is desirable that some standard method should be adopted for testing iron in samples of commercial size, and preferably in commercial shapes. The paper also indicates the desirability of selecting such irons as have not only first-class magnetic properties, but also as low an electrical conductivity as possible.

Prof. C. A. ADAMS: The fact that the total loss curve approaches closely to the 1.6 power curve is hardly sufficient ground for the conclusion that the eddy loss follows the 1.6 power law. The curves in the accompanying figure illustrate this point clearly. The coefficients in the formula for curve A were chosen to suit a series of observed curves taken at frequencies from 25 to 350 cycles per second, from good quality of

commercial transformer iron, and it will be observed that this curve differs very little from curve B which is a 1.6 power curve.

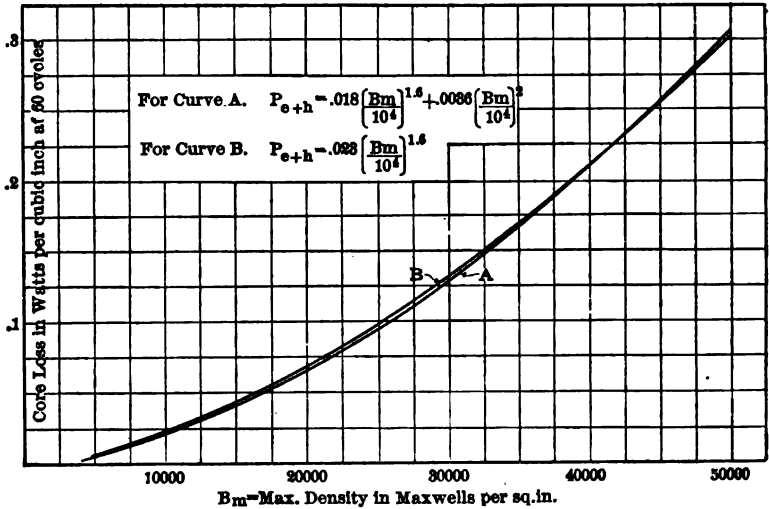

PROF. RYAN: I would like to add a remark with regard to the value, in my estimation, of using the beautiful Duddell oscillograph in connection with the wattmeter, in making tests of this character. If we might have papers like Mr. Mordey's supplemented with oscillograph reports of the wave-forms of magnetic flux that were employed, accompanied by their scales in absolute measure, those who are interested in the scientific value of such papers might be able to interpret many things that they otherwise can not, and I believe at the same time, to have such results so supplemented by these oscillograph records would greatly assist the trained judgment of the engineer when he comes to apply the wattmeter results.

Mr. W. DUDELL: With reference to the hysteresis cycle, a method has lately been described in England for recording the hysteresis cycle under actual working conditions; that is to say, the instantaneous hysteresis cycle. The method is due to Doctor Morris of Birmingham. In case any members may not have heard of it, I will briefly describe the principle, omitting all the details, for it seems as if it will help to clear up a number of questions as to what is going on during actual working.

The transformer, or a magnetic circuit, made of the iron to be tested, has a magnetizing coil and a test-coil wound on it. Let N be the total flux through the test-coil, and let a highly inductive air-core choking coil be connected to the terminals of the test-coil. Neglecting the resistance, the current in the test-coil circuit will be given by the equation $\frac{L di}{dt} = \frac{dN}{dt}$. So that by this means we obtain a current i whose instantaneous value is proportional to the instantaneous value of the total flux N . The mag-

netizing current is also proportional to the magnetizing force. If each of these currents be passed through an oscillograph, we have the two mirrors vibrating, the deflection of the one being proportional to the flux, and the other to the magnetizing force. If a beam of light be reflected from the two mirrors in succession, so as to combine their two vibrations at right angles, the resulting beam of light will describe the instantaneous hysteresis loop on a screen or plate. This can be easily accomplished by passing the beam of light reflected from the first mirror through a prism and reflecting it back on to the second mirror by means of a concave mirror.

I hope Doctor Morris' very neat method is going to give many useful results. A description of the method can be found in the *Transactions of the Institution of Electrical Engineers of Great Britain*.

CHAIRMAN STEINMETZ: If there is no further discussion, we will proceed to the next paper, which is by Doctor Sharp, on "The Equipment of a Commercial Testing Laboratory." As most of you probably know, Doctor Sharp has been identified for some years with a testing laboratory which he has organized and brought from small beginnings to a standing of the highest reputation in this country, so that he is amply qualified to speak to us on the organization of a testing laboratory. I will call upon Doctor Sharp to abstract his paper.

THE EQUIPMENT OF A COMMERCIAL TESTING LABORATORY.

BY DR. CLAYTON H. SHARP.

In the equipment of a commercial testing laboratory, certain conditions, which are imposed by the nature of the work to be done, must be kept clearly in view.

It is essential, first, that the work be carried out with accuracy, and second, with dispatch and low cost. When it is said that the work must be carried out with accuracy, it is not meant that the accuracy should be the highest attainable, such as results only from an entirely uncommercial painstaking care and repetition, but rather that its accuracy should fulfil all the requirements of commercial conditions. It is also necessary that the equipment be such as will enable the accuracy attained far to exceed ordinary demands when that is requisite.

In order to carry out testing work fulfilling this condition of accuracy, it is necessary in the first place that the laboratory be equipped with the best fundamental standards and what may be called primary apparatus. The arrangements for the measurement of electromotive force, of current strength and of resistance must be such that the degree of accuracy with which these measurements can be carried out approaches the highest attainable. In order to obtain a high commercial accuracy in the ordinary testing work of the laboratory and at the same time fulfil condition two, namely that of dispatch and low cost, the equipment should include a considerable number and variety of the highest grade of direct reading instruments. These instruments must naturally be carefully checked against fundamental standards, the errors determined at all parts of their scale and then their corrected readings taken in future work.

It is necessary further to notice that to do work quickly and cheaply the amount of time required for preparing for a test and carrying it out must be minimized. It is frequently, perhaps usually, the case under ordinary conditions that the time required in preparing for a test is greater than that required in making the

actual measurements. To reduce this time, the method of making all the ordinary tests must be laid out in advance, all the requisite apparatus must be put permanently into position and all electrical connections must be made, so that it is necessary only to connect the article to be tested into the circuit, throw a switch or two and proceed. In cases where a test is not required so frequently as to justify the setting apart a particular apparatus exclusively for carrying it out, a place at least should be assigned to it in the laboratory and all necessary wires and switches installed, so that the measuring instruments and the apparatus or materials to be tested have their definite and predetermined place, and the connections are already arranged so that they can be put into service with very little delay.

The chief item of expense of most testing arises from the labor cost. When the test is carried out by a trained and skilled engineer or physicist, the labor cost of a test is usually very high. To bring testing to a commercial basis, it is necessary to reduce this labor cost to a minimum. This can be done partly by arrangement of apparatus in such a way as to minimize the time required, and partly by so systemizing the work of testing that the actual operations can be carried out by assistants who have been thoroughly instructed in all the details appertaining thereto, and who have proven themselves to be competent, careful and accurate in their work. With careful supervision and inspection, the work which can be carried out in this way need not be in any respect inferior to that which would be done by a highly trained man, and it is done at a very much lower labor cost.

DISTURBING INFLUENCES.

It is very desirable that the building occupied by a testing laboratory should be constructed either with very firm walls and floors or else that it should have a sufficiently large plan so that instruments which are sensitive to vibration can be put on the ground floor or on piers reaching down to the earth. Various devices are available for protecting a delicate instrument from vibration, such as spiral spring suspensions, mercury flotation, the Julius suspension, etc. Such devices are a common cause of annoyance and delay, and should be avoided when possible.

When the laboratory is so located that it is subject to disturbances due to magnetic changes, earth currents, etc., the practically

universal use of the d'Arsonval type of galvanometer is imperative. Such galvanometers are constructed suitable for the vast majority of electrical tests, and the use of this type is dictated by all considerations of convenience, quickness of working and freedom from outside disturbance, both magnetic and mechanical, wherever suitable instruments are available.

DISTRIBUTION OF CURRENT.

Electrical wires should be run as far as possible in the open on porcelain knobs and cleats, or their equivalents.

Abundant provision should be made for artificial lighting. It is very desirable to have lamp sockets wired to the lighting circuits distributed about the laboratory, in such a way that they are available for local lighting or for the supply of power to small motors simply by screwing in an attachment plug.

For distributing current to the various portions of the laboratory and for bringing these various portions into electrical connection with each other, a distribution switchboard is required. The most practical form of this board is one in which the connections between the sources of supply and the circuits to the various instruments are made by flexible cords with suitable jacks on the ends. The lines from the sources of supply and to the instruments and various portions of the laboratory are connected to receptacles on this board. These receptacles may be either in the form of spring-clips, similar to the clips of a knife-switch, of tapered holes bored out in solid blocks or in any one of the various forms which are well known. The spring-clips with the flat jack constitute what is probably the best form of receptacle for the purpose.

It is a good plan to wire up to this distribution-board a set of transformers, suitable for giving the various combinations of alternating current pressure required. One or more autoconverters may be wired up in this way, having all of their taps brought to receptacles on the board. This type of transformer is very convenient for laboratory use on account of its great flexibility and range.

INSULATION.

On account of the great trouble caused by leakage currents, due to the grounding of batteries and of lines and instruments connected therewith, it is very important to see to it that all electrical

connections are very thoroughly insulated. Lines should be run with heavy rubber-covered wire. Apparatus should be set up as far as practicable on carefully-leveled tables with stone or slate tops. The floor of the laboratory should be of insulating material. For this purpose and on account of its numerous other good qualities, linoleum can be highly recommended.

In spite of all precautions to secure good insulation, leakage is quite certain to occur at certain periods in a climate such as that of New York. This is due to the excessive humidity of the atmosphere, which causes the deposition of a conducting film of moisture on the surface of insulators. This may be avoided by reducing the humidity of the atmosphere in a certain room or rooms of the laboratory, in which tests of high delicacy or accuracy are made. For this purpose a refrigerating plant is required. A refrigerating machine of sufficient capacity may be used to lower the temperature of a bath of brine, which is carefully insulated from its surroundings. This cold brine is then forced by a pump through coils of pipe situated near the ceiling of the room which it is desired to keep dry. By this means a large amount of moisture can be removed from the air and, when this air has become heated, either by contact with the walls of the room or by any special heating device in the room, its relative humidity is much reduced, and conducting films are evaporated from the surfaces of insulators.

TEMPERATURE CONTROL.

Arrangements must also be made for temperature control during tests. To fit cases where only a constant or slowly-varying temperature is desired, more or less irrespective of what that temperature is, such control is most readily obtained by the installation of a proper subterranean or partially subterranean vault. The refrigerating plant is a most useful auxiliary in connection with temperature control. A room with insulating walls may be set apart and may be equipped with coils connected with the brine-circulating system, and with a suitable system for heating, preferably electric. A thermostat should be installed on both the heating and the cooling systems, so that any desired temperature can be obtained and maintained constantly.

For tests of smaller apparatus, where, for economy's sake, it is undesirable to heat or cool an entire room, a box with insulating walls and with a heating and cooling system may be installed.

A compressed-air plant with pipes leading to outlets in various parts of the laboratory is a convenient auxiliary, being useful not only for cleaning testing-tables, apparatus, etc., but also for the operation of blast-lamps and pneumatic control devices.

SUPPLIES OF ELECTRIC CURRENT.

Direct current both from machines and from storage batteries, and alternating current of all commercial frequencies, must be available for use. The dynamo direct-current supply should take the form of a 3-wire or 5-wire system. The latter is a very desirable arrangement, since it gives a greater range of voltages for testing and for charging storage batteries, and since it is applicable to an efficient system of multiple speed-control for motors.

The storage-battery equipment should include an outfit of small cells sufficient for voltmeter-checking, for exciting the potential circuits of recording wattmeters, etc., of a battery or batteries of considerable capacity suitable for supplying current for photometric testing and for heavy testing and power purposes generally, and of a battery of comparatively small number of large cells which can be connected in various series and parallel combinations and which will yield heavy currents at low voltage.

If the direct current supplied to the laboratory originates in the building from a dynamo or dynamos, driven either by an engine or by an electric motor, the e.m.f. on this system may be controlled by an automatic regulator sufficiently close so that its current is directly applicable to heavy tests and to power purposes where very steady voltage is required. The recently-introduced Tirrell-Andrews regulator of the General Electric Company is capable of accomplishing this purpose very perfectly. For power purposes a direct-current system controlled by its aid is to be preferred to a storage battery.

It is very convenient to have a constant alternating-current supply on the distribution-board of the laboratory. The frequencies most commonly required are 25 and 60 periods per second. In the supply of alternating current at these and other frequencies a motor-driven alternator set can be used. This set will best take the form of two revolving-field alternators, exactly alike and normally coupled together by a rigid coupling. For wattmeter tests, the current for the wattmeter is taken from one of these machines through a transformer, which steps down the pressure to such a

value that the current is readily controlled by low-resistance rheostats, while the e.m.f. is taken from the other machine, also through a transformer if necessary. The armature ring of one or both of the machines is arranged so that it can be shifted through a sufficient angle by means of a worm-gear. By shifting the armature ring of one machine while that of the other remains stationary, the apparent power-factor on the wattmeter under test can be varied at will. Since such mechanical phase-shifting does not involve any change in the e.m.f. of the machines, the points at which the power-factor is equal to unity is readily determined by noting where the reading of an indicating wattmeter reaches its maximum value. Similarly the point for zero power-factor can be obtained. By attaching a suitable scale to the armature-ring, the machines can be set to yield any desired power-factor. If these dynamos are polyphase machines, with the terminals of the windings brought out to a suitable switching device, currents of various phase relations can be obtained from them and their usefulness is materially enhanced. By using various connections of the windings a certain amount of variation in the wave-form of the alternating current can also be obtained.

STANDARDS.

The most important primary standards with which a commercial testing laboratory has to do are those of e.m.f. and resistance. Important secondary standards are standards of electrostatic capacity and of luminous intensity.

A laboratory should be equipped with a complete outfit of standards of e.m.f. in the shape of Clark and Weston standard cells. The Clark standard cells find their principal utility in giving a check on the accuracy of the Weston cells, since the ratio of e.m.f. of the Clark cell to that of the Weston cell has been very accurately determined. In the actual work of the laboratory, the Weston cell, either in the form using a saturated solution of cadmium sulphate at all temperatures (Weston normal cell) or in the form in which it is put on the market by the Weston Electrical Instrument Company, and which has a negligible temperature coefficient, is undoubtedly the best to employ. Both forms of this cell have been very thoroughly tested for their reliability and have been found to be almost above suspicion.

Standards of resistance should be constructed of manganin wire or strip, mounted preferably in the manner recommended by the Reichsanstalt or in some similar way. These standards should be arranged for oil immersion, in order that the heat may be carried off from the strips and the temperature may be accurately determined. A set of standard resistances varying in value from 0.0001 ohm to 100,000 ohms by decades should be provided. The lower resistances of this series should be so constructed as to serve for the accurate measurement of current by the fall of potential method. It is an advantage to have a duplicate set of such resistances for intercomparison, since it is a well-ascertained fact that their value is subject to change.

In order to enable check determinations to be carried out, the laboratory should be equipped also with suitable apparatus for measurement of current by the electrolysis of silver. This is an experiment which fortunately needs to be carried out only very infrequently.

As a standard of capacity, a mica or silvered mica condenser is sufficient for most purposes.

While it is desirable that the testing laboratory should be equipped with primary standards of luminous intensity, especially the Hefner lamp and the Harcourt 10-candle pentane lamp, yet these primary standards are not indispensable. Their place is more than taken by a series of incandescent lamps which have been carefully seasoned, and the candle-power of which at given voltage has been measured against primary standards in a suitably equipped laboratory. By taking proper care and precautions, these standards can be copied in the testing laboratory; and, by making use of these copies and by multiplying them, it is possible to maintain a very great constancy as far as the actual standards used in photometric measurements are concerned. The photometric standards in use by the Electrical Testing Laboratories, New York, have been derived in this way from lamps standardized at the Reichsanstalt nearly 15 years ago.

Lamps standardized by the Electrical Testing Laboratories have recently been measured in a number of other laboratories, the measurements being carried out in the following order:

Electrical Testing Laboratories, New York.
National Physical Laboratory of England.
Ediswan Lamp Works, Ponders End.

Laboratoire Central d'Electricité, Paris.

Physikalisch-technische Reichsanstalt, Berlin.

Pender Laboratory, University College, London.

Electrical Testing Laboratories, New York.

National Bureau of Standards, Washington.

The results of these measurements, which are given in the following table, serve not only to show that the standard maintained by the Electrical Testing Laboratories by the use of incandescent lamps has not varied from the Reichsanstalt standard, but also to give an interesting and valuable comparison between the standard of luminous intensity which is in most extensive use in the electric-lighting industry in this country and foreign standards.

SHARP: TESTING LABORATORY.

Lamp No.	Nat. Phys. Lab.		Pender.	Ediswan.		L. C. E.	P. T. R.			E. T. L.	National Bureau of Standards.
	Fleming standards, Nos. 9 and 16 as reference standards			Fleming standards.	10-C. P. Pentane lamp standard.		Hefner candles reported.	Values actually observed.	Assuming that $1 \text{ H.K.} = 0.68 \text{ C.P.}$		
	C. P.	C. P.	C. P.	C. P.	Bougies décimales.				C. P.	C. P.	
1	16.87	17.17	17.6	18.0	18.08	15.87	15.85	15.85
2	16.87	16.91	17.9	16.1	18.1	18.12	15.95	16.04	15.9
7	16.74	16.88	17.08	17.4	18.1	18.05	15.86	15.99	15.8
11	17.06	17.04	17.15	16.3	18.2	18.19	16.00	15.99	15.95
15	16.87	16.98	17.27	18.1	18.14	15.95	15.89	16.0
17	16.94	17.18	18.2	18.24	16.05	16.01	16.0
Mean...	16.89	16.97	17.11	17.6	16.2	18.12	18.18	15.95	15.96	15.93

THE MEASUREMENT OF ELECTROMOTIVE FORCE.

The primary measurements of e.m.f., as well as all measurements of high precision, should be made with a potentiometer and Weston cell. Potentiometers may be divided into two general classes, namely: the high-resistance and the low-resistance ones. In the high-resistance potentiometers, the various resistances are composed of coils. In the low-resistance potentiometers, some form of slide-wire must be used. On account of the greater reliability of resistance coils as compared with the slide-wire, the high-resistance potentiometer is probably the best for the great bulk of work. The low-resistance potentiometer has, however, the advantage of requiring a less sensitive galvanometer, especially when used in current measurements by the fall of potential method, and, beside, it lends itself more readily to the accurate determination of very small e.m.f.'s, since the effective "length" of the potentiometer, if we may so call it, may readily be extended by putting a resistance-box in series with it. In the ordinary work of the laboratory in the measurement of e.m.f.'s, and in checking portable voltmeters, it is sufficient to use a Weston laboratory standard voltmeter as a secondary standard. This voltmeter must be carefully checked throughout its scale against the standard cell, and should preferably be kept always in one position.

For measurement of alternating e.m.f.'s, a Weston direct-alternating voltmeter may be used. This should be of the large or laboratory standard type. Since an instrument of this sort is liable to show an inductance error, it is not sufficient for purposes of precision to check it on direct current alone. It should be checked on alternating current of the frequency with which it is to be used, using an inductionless electrostatic instrument as a transfer instrument from direct current to alternating current. A Kelvin multicellular voltmeter equipped with a mirror and with a telescope and long, curved scale forms a satisfactory transfer instrument for this purpose. The accuracy which is attainable by its use depends upon the steadiness of the alternating pressure available. With very steady pressure, this accuracy can be carried beyond 1/10 per cent in the ordinary ranges of electrotechnical work.

INTENSITY OF CURRENT.

The standard and best method at the present day for the measurement of direct current is by the use of the manganin low-resist-

ance standard, through which the current is passed, and a potentiometer and standard cell for measuring the difference of potential between its terminals. These standard resistances have been referred to in the foregoing.

As working standards for the measurement of current to an accuracy not to exceed 0.1 per cent, a Weston millivoltmeter of the laboratory standard type may be used. A series of shunts should be provided with this millivoltmeter, so chosen that their ranges will overlap, so that no readings need be made very low on the scale of the millivoltmeter. Correction curves of the millivoltmeter with each of its shunts need to be made and checked up occasionally.

A series of Kelvin balances is very useful. If such a series is in the possession of a laboratory, it is possible even to dispense with the manganin current-measuring resistance. For direct-current work, however, the balances are less convenient than the manganin resistance with potentiometer. It is for alternating-current measurements that the balances are most useful. They are undoubtedly the best instrument for this purpose.

A series of Siemens electrodynometers may be used for alternating-current measurements, but they require rather frequent checking.

A type of instrument which is useful in this connection is the deflecting electrodynometer similar to that designed by Professor Rowland and manufactured by the Leeds & Northrup Company. This instrument is actually a wattmeter, since the main current passes through the field coils of the instrument and the deflecting coil is simply placed in multiple with a shunt in the main circuit. An instrument of this type is much more convenient if its moving part is made astatic by providing two movable coils oppositely wound. It can be calibrated on direct current with very little trouble and is then applicable to alternating-current measurements. The copper constituting its field coils should be thoroughly laminated or subdivided so as to break up eddy currents. This is particularly important on heavy-current instruments.

As a variant on this method of measuring large alternating-currents, mention may be made of the use of a sensitive deflecting electrodynometer with fine-wire stationary coils used as a millivoltmeter about a non-inductive shunt. If the shunt has sufficiently high resistance, the inductance of the sensitive deflecting

instrument, being small, may be made negligible by putting non-inductive resistances in series with it.

Instead of the electro-dynamometer, a sensitive electrometer or electrostatic voltmeter may be used to measure the fall of potential about the shunt.

The series of instruments for alternating-current measurements may be supplemented by a set of ammeters, of either the soft-iron or hot-wire type. For purposes of calibrating alternating-current instruments, a standard lamp bank is of value. By this is meant a set of sockets very heavily wired together and a set of seasoned lamps, the current consumption of which at a given voltage is accurately known. These lamps should be selected of various sizes, following out in general the scheme of a plug-resistance box, so that by introducing the proper lamps into the circuit practically any current strength can be obtained within the range of the lamp bank. The use of such a lamp bank requires only a carefully calibrated alternating-current voltmeter to adjust the voltage on the bank.

POWER.

Standard wattmeters should be selected with a view to their fulfilment of the necessary requirements, namely, that they shall be of very low inductance, which quality involves a feeble control of the moving coil, and that they shall be free from eddy currents. The latter condition requires that no metal parts shall be used in the construction of the instrument and that the wires constituting the field windings shall be built up of many fine strands, insulated from each other and intermingled in irregular fashion.

Wattmeters fulfilling these requirements are those of the Duddell-Mather type, made by Paul in London. These are zero instruments of the electro-dynamometer type with astatic coils and switching devices placed at some distance from the coils, by which the various fixed windings can be put in series or parallel and to which the current-leads can be attached.

Standard Kelvin balances for the measurement of power are also obtainable, as well as laboratory standard Weston wattmeters. Portable wattmeters are obtainable of Weston, Siemens & Halske, Hartmann & Braun, and Kelvin types. The last two are astatic instruments.

The Rowland electro-dynamometer is also capable of making

measurements of power. It is particularly valuable where small amounts of power or low power-factors have to be measured.

RESISTANCE.

In the measurement of resistances of ordinary magnitudes, a Wheatstone bridge of the dial or decade type is the most practical instrument. A very practical arrangement of the bridge is to connect permanently in circuit with its battery and galvanometer leads a double, revolving contact-maker (secohmmeter). In ordinary measurements of resistance, this serves as a reversing switch for battery and galvanometer terminals. By driving it with a motor, which should be permanently belted to it, the bridge becomes at once available for measurements of capacity and of coefficients of self and mutual induction.

For measurements of low resistance, including the intercomparison of low-resistance standards, and the determination of the conductivity of copper and other metals, the best arrangement is that of the Kelvin double bridge. An excellent resistance-box, arranged as a Kelvin double bridge, which suffices for all measurements of a testing laboratory, is made by Wolff in Berlin. A direct-reaching conductivity bridge is more convenient when much of this work has to be done.

For measurements of high resistance, such as the resistance of insulating materials, a high-resistance galvanometer is required. For nearly all purposes, a high-resistance, highly-sensitive d'Arsonval galvanometer suffices. This galvanometer should be of the open-coil, iron-core type, rather than of the shuttle type, which involves too large an air-gap. The galvanometer and all other parts should be very carefully insulated, and guard-wires should be installed in making all such tests.

For insulation tests which are beyond the range of such a galvanometer, a very high resistance and very sensitive Kelvin astatic galvanometer may be used, or recourse may be had to the method of leakage, using a condenser and electrostatic voltmeter or quadrant electrometer.

HIGH-TENSION TESTS.

For high-tension tests, a high-tension oil-insulated transformer of considerable kilowatt capacity is required. In a transformer made by the General Electric Company, the windings are subdi-

vided into four sets for 30,000 volts each, so that the whole capacity of the transformer (10 kilowatts) may be obtained at maximum tensions of 30, 60, 90, and 120 kilovolts. The proper method of control of voltage of such a transformer is to vary the impressed primary voltage. In case the transformer is supplied by a separate dynamo, this may be done by varying the field excitation. When the supply comes from constant potential mains, it should be done by a variable choke-coil.

It is useful also to have high-tension direct current available. This may be obtained from a set of small direct-current dynamos, connected in series, or from a single machine after the Thury system. Small machines may be obtained which will furnish 2000 volts each. These must be very carefully insulated from each other and from the driving motor. Each machine should be separately excited by a little dynamo directly connected to it by means of a flexible rubber coupling or its equivalent. The Thomson dynamostatic machine of the General Electric Company furnishes another means of obtaining high potentials.

For the measurement of high potentials, electrostatic instruments are required. A Kelvin electrostatic voltmeter is constructed, reading to 50,000 volts directly. Electrostatic voltmeters of lower range may be used in connection with a series of condensers in potentiometer arrangement to subdivide the voltage. A highly insulated spark-gap furnishes another means of determining the maximum voltage. For the test of line insulators, an arrangement for producing an imitation rainstorm is required.

All the high-tension instruments and apparatus should be installed with a view to the safety of the operators. A good plan is to arrange these parts in a cabinet with glass windows which must be raised to give access to any part which is subject to a high tension. Switches are so placed that the act of raising any window will disconnect all high-tension circuits, making it perfectly safe to handle any of the apparatus as soon as it becomes accessible.

INSTANTANEOUS PHENOMENA.

Rapidly-varying currents, especially those involved in the opening of switches, circuit-breakers, etc., on high-tension lines, containing inductance and capacity, commutator currents on direct-current machines, and all similar instantaneous phenomena can be studied by the aid of an oscillograph. Two types of oscillographs

only need be considered: First, the soft-iron strip type, in which a strip of soft iron carrying a minute mirror oscillates in a field produced by the current to be studied passing through galvanometer coils close to the strip; and, second, the double-filament type, in which the current to be measured passes through a very thin metallic band stretched across and back through an intense magnetic field and carrying also a minute mirror. Both these types are due to Blondel. The latter type is inductanceless and operates with very low voltages. It is probably somewhat more delicate to handle and more liable to injury than the soft-iron type. Oscillographs of the double-strip type are made by Carpentier of Paris (Blondel oscillograph), by the Cambridge Scientific Instrument Company of Cambridge, England (Duddell oscillograph), and by the General Electric Company. The Carpentier oscillograph is made interconvertible, so that either the soft-iron or the double-strip type movement may be employed. The General Electric Company oscillograph is remarkable for the comparative ease with which the strips can be replaced in case they become damaged.

ALTERNATING-CURRENT CURVE.

These may be obtained, not only by means of an oscillograph, but also by apparatus adapted especially to their measurement. The latter are founded on the instantaneous-contact method. In the wavemeter of the General Electric Company, the contact-maker is driven by a synchronous motor. The latter alternately charges a condenser and discharges it through the measuring instrument. The latter may be an ordinary direct reading voltmeter. By taking readings of the voltmeter as the brush on the contact maker is advanced step by step, a series of values is obtained from which the alternating-current wave may be plotted. This instrument is also furnished with a camera box and galvanometer, whereby the wave can be photographed directly on a moving plate. In the Rosa curve-tracer, the voltages picked up by the contact-maker are balanced against a direct-current voltage subdivided by a potentiometer wire. By a simple device, the excursions of the contact on the potentiometer wire necessary to bring the galvanometer deflections to zero are recorded on a sheet of cross-section paper wrapped around a drum, so that the record is obtained in the form of a series of points on this paper.

The ondographe of Hospitalier is a simple, convenient and excellent apparatus for this purpose. It is similar in principle to the wavemeter of the General Electric Company, but the galvanometer deflections are directly recorded on a moving strip of paper by a pen actuated by the galvanometer.

MAGNETIC PROPERTIES OF IRON.

The ring method, which may be said to be the standard method, requires a standardized ballistic galvanometer. This should be preferably of the d'Arsonval type and should be damped only by short-circuiting. The period of such a galvanometer is readily increased by hanging weights on the suspension. It is most conveniently standardized by the use of a pair of coils, the mutual inductance of which has been determined either by computation or measurement.

For industrial purposes it is important to be able to use the yoke method of test. An apparatus employing this method, which is not open to the ordinary objection that no account is taken of the magnetic reluctance of the joints, is the permeameter of Picou made by Carpentier. In this apparatus, the m.m.f. required to carry the lines of induction across the joints and through the yoke is supplied by windings on the yoke itself, leaving the magnetizing coils about the test-piece to furnish only the necessary m.m.f. to carry the induction from one end to the other of the test-piece. This permeameter requires the use of a ballistic galvanometer.

In the apparatus of Koepsel, manufactured by Siemens & Halske, the induction in the test-piece is measured by a voltmeter movement arranged in an air-gap in the yoke. The pointer then indicates the value of the induction directly. The magnetizing force is determined by ammeter measurements. This is the most convenient apparatus for the rough determination of permeability and of hysteresis loops, but if higher accuracy is desired the curves obtained by its use need to be sheared over to take account of the reluctance of the joints and of the air-gap. The amount of this shear differs with different materials, so that the correction applied is in general at most an approximate one. The amount of shear at zero magnetization may be obtained by a separate experiment with a magnetometer. If this is done, the approximation may be made quite close.

PHOTOMETRY.

The photometric equipment will vary according to the amount of this work which has to be done. For most accurate work, a long track of the Reichsanstalt pattern should be provided and should be fitted with suitable rotators for incandescent lamps, with a Lummer-Brodhun contrast photometer, with Weston laboratory standard voltmeter and ammeter, and with a potentiometer and standard resistances. It is necessary in particular to notice that the photometer track should be furnished with a set of suitable screens for cutting off all traces of stray light from the photometer disc.

For more rapid work with incandescent lamps, one or more photometers of the pattern commonly used in lamp manufactories should be provided. A most excellent form of photometer of this general description is in use by the Electrical Testing Laboratories of New York. This photometer is very little inferior in point of accuracy to a standard photometer, while it is capable of very rapid work. For this class of work with skilled operators, the Bunsen sight-box with a sensitive Leeson star-disc is the best photometer arrangement, practically equal to the Lummer-Brodhun photometer in accuracy and excelling it in ease and comfort to the operator.

For the determination of mean spherical candle-power of incandescent lamps, the integrating photometer of Professor Matthews is a very convenient and reliable apparatus.

For the measurement of arc lamps, another arrangement due to Professor Matthews is also excellent. In this arrangement the arc lamp is placed in the center of a vertical truncated pyramid of 24 large mirrors. The light from these mirrors is sent to a focusing point, at which the photometer disc is placed. In the path of each beam is placed a sector of smoked glass, which by its absorption diminishes the intensity of each beam in the ratio of the cosine of the angle which the mirror sending that particular beam makes with the horizontal to unity. Under these circumstances, the illumination received by the photometer disc is proportional to the total flux of light emitted by the lamp, and consequently to the mean spherical candle-power of the lamp. The same arrangement of mirrors suffices for the determination of the vertical distribution of luminous intensity about the lamp.

For the measurement of the distribution of light about shades, reflectors, etc., special arrangements are required which will suggest themselves to the experimenter.

GENERAL AND AUXILIARY APPARATUS.

In addition to the apparatus outlined above, the laboratory should be equipped with a general provision of resistance-boxes of various sizes, with condensers of both mica and paper, with portable direct-reading instruments, with a portable potentiometer, with recording instruments and stop-watches. The details and scope of this portion of the equipment is something which can be settled upon only by a study of the peculiar needs of the laboratory in question, while the general nature of this apparatus makes it possible to select it without difficulty from the standard lists of apparatus-makers. *

CHAIRMAN STEINMETZ: If there is no discussion, we will proceed to the next paper, on "Electrolytic Rectifiers," by M. Albert Nodon.

ELECTROLYTIC RECTIFIERS — AN EXPERIMENTAL RESEARCH.

BY ALBERT NODON.

An electrolytic valve is a device which is able to interrupt the flow of an electric current when it is in one direction, and to permit its free passage when in the other direction. It consists essentially of a metallic anode of small surface, a cathode of large surface and an electrolyte, which last is generally a salt solution.

Historical.

Buff discovered in 1856 the property which is possessed by aluminum, when dipped in a salt solution, of allowing a free flow of current in one direction, but of stopping the flow when in the opposite direction; Ducretet utilized this property in 1874 for constructing an alternating-current rectifier; Leo Gratz studied a particular method of setting up the apparatus; Carl Liebenow investigated the electrolyte; Pollack made a number of investigations upon the valves and obtained the first results of industrial value.

In 1899 the present writer reviewed what had previously been done and conducted a series of researches at the Sorbonne and the Collège de France, with a view to throwing light upon a problem as yet but little understood. These investigations constitute the subject of the present paper.

The Valve Effect.

The valve effect is in general one obtained by means of any metal dipped in an electrolyte and subjected to a definite difference of potential. The phenomena of double layers appear to be associated with the valve effects.

Ionization Phenomena.

The value of the electric charge that may be obtained by means of the valve effect is greater as the molecular weight of the metal

which constitutes the anode is smaller. Magnesium and aluminum admit of the valve effect being obtained under a high difference of potential; metals of large atomic weight, such as lead or mercury, on the other hand, produce the valve effect only under a low difference of potential. This effect thus produced bears the name of double layer.

Cathode.

In theory, the nature of the cathode is without influence upon the valve effect, if its relative surface be sufficient. In practice, lead or polished steel, are principally used as cathodes.

Current Density at Anode.

For any definite metal constituting the anode and dipped in an electrolyte at fixed temperature under known difference of potential, the magnitude of the charge that it is capable of acquiring during unit of time under the valve effect depends upon the current density at the anode surface. This charge depends also upon the effective surface of the anode and the disposal of this surface relative to the cathode. The nature of a metallic alloy, when employed as anode, plays also an important part in this phenomenon.

Electrolyte.

The valve effect may be obtained with ordinary water. In practice, however, the choice of electrolyte is important in the operation of the valves as a result of the more or less destructive nature of the secondary products of the electrolytic reactions. With magnesium, the best results are obtained by means of a saturated solution of alkaline fluorides. With aluminum, the most perfect action is secured by means of neutral ammonium phosphate. The phosphates of potassium and sodium give rise to free potassium and sodium which attack the electrodes and produce an imperfect action of the valves.

In the following table are given results which were obtained by the aid of anodes made of different metals in electrolytes of various composition. The cathodes were of graphite and the experimental conditions were the same in all determinations. The measurements were made while cool, with the assistance of a constant temperature apparatus of Chauvin and Arnoux. The cur-

rent was furnished from a storage battery capable of maintaining a difference of potential of 85 volts. In the table the letters at the head of the columns have the following signification:

S = nature of the solution.

M = nature of the metal anode.

U = e.m.f. in volts between the two electrodes of the valve, which are connected with the voltmeter.

U' = potential difference in volts between the valve electrodes at the instant of changing the direction of the continuous current by means of a commutator.

I' = current in amperes escaping in valve from metal to graphite.

I = strength of direct current, in amperes, from graphite to the cathode metal.

<i>S.</i>	<i>M.</i>	<i>U.</i>	<i>U'.</i>	<i>F.</i>	<i>I.</i>
Potassium fluoride.....	Aluminum	85	90	2.9	3.7
" "	Cadmium	85	17	4.0	4.0
" "	Bismuth	85	16	4.0	4.1
" "	Antimony	85	16	4.0	4.1
Ammonium fluoride.....	Magnesium	16	19	0.1	3.9
" "	Aluminum.....	20	26	0.1	3.8
Ammonium fluorsilicate	Aluminum	54	1.2	3.4
" "	Magnesium	54	1.2	3.4
" "	Bismuth.....	No valve effect.			
Ammonium carbonate	Aluminum.....	15	43	0	3.8
" "	Bismuth	64	20	0.10
" "	Antimony	64	20	0.10
" "	Magnesium.....	No valve effect.			
Ammonium oxalate.....	Aluminum.....	4	56	0	1.7
" "	Bismuth	45	0.2	2.65
" "	Antimony.....	75	0.5
" "	Cadmium.....	68	0.2
Ammonium phosphate.....	Aluminum.....	4	50	0	2.1
" "	Bismuth	20	38	0.1	2.35
" "	Antimony.....	No valve effect.			
" "	Cadmium.....				
" "	Magnesium.....				
Double phosphate of ammonium and potassium.....	Aluminum.....	8	25	0	3.22
Potassium phosphate.....	Anodes attacked..

The following facts may be deduced from the table:

1. Magnesium, cadmium, bismuth and antimony do not give rise to the valve effect.

2. Aluminum alone does this.

3. Anodes are attacked when potassium or sodium salts are employed. A precipitate of alumina is produced with aluminum anodes.

4. Only the carbonate, oxalate or phosphate of ammonium produce the desired result.

5. An increase of the internal resistance of the valve is demonstrated, upon opening the circuit and at the instant of reversing the current.

Valve Resistivities.

The following measurements have been made by means of valves whose electrodes have been constructed of different materials and whose electrolytes have been different ammonium salt solutions. The column headings have the following significance:

A = metal from which the anode is constructed.

C = nature of the cathode.

D = nature of the electrolyte.

N = character of the current; *dc* for continuous, *ac* for alternating.

R = resistance of the valve in ohms per cm² at closed circuit.

r = resistance of the valve in ohms per cm² at open circuit.

A.	C.	D.	N.	R.	r.
Lead.....	Lead.....	Double phosphate of potassium and ammonium	dc	6.29
"	Aluminum	Double phosphate of potassium and ammonium	dc	18.9
Al. + 5% Ni.....	Al. + 5% Ni.....	Double phosphate of potassium and ammonium	dc	12.11
Lead.....	Lead.....	Double phosphate of potassium and ammonium	ac	8.39
Al. + 5% Ni.....	Al. + 5% Ni.....	Double phosphate of potassium and ammonium	ac	6.91
Aluminum.....	Lead.....	Double phosphate of potassium and ammonium	ac	60.00
Lead.....	Lead.....	Ammonium carbonate.....	dc	8.84
"	Aluminum.....	"	dc	18.9
"	Al. + 5% Ni.....	"	dc	8.84
Al. + 5% Ni.....	"	"	dc	15.00
Lead.....	"	"	dc	12.47
Lead.....	Lead.....	Ammonium carbonate.....	ac	10.63
Al. + 5% Ni.....	"	"	ac	61.50
Bismuth.....	"	"	ac	10.63
Antimony.....	"	"	ac	12.17
Aluminum.....	Graphite.....	"	ac	23.00
"	Lead.....	"	ac	30.00

From the above table the following deductions may be drawn:

1. The specific resistances of saturated solutions of double phosphate of potassium and ammonium, of neutral phosphate of ammonium and of carbonate of ammonium are about equally large, that is from 6 to 9 ohms per cm².

2. Lead gives a special resistance of 2 ohms owing to the formation of a layer of lead oxide.

3. The resistance manifested between aluminum and the passive cathode at the moment of reversal of the valve is about three times as great as that of the electrolyte. The resistance of the film about the anode then increases up to the maximum limit. The resistance of the electrolyte then becomes practically negligible compared with that of the film.

4. The resistance of the valves connected in series is proportional to the number of valves.

Electrolytic Hysteresis.

The value of the electrolytic hysteresis in the valves is the ratio of the time required for the formation of the valve to that required for its destruction. The action of the valves is affected, under good conditions, only with a hysteresis value equal or inferior to unity. The lowest hysteresis value with aluminum is given by ammonium phosphate; for magnesium and ammonium fluoride this value is lower than unity.

Microscopical Examination of the Anode.

If the surface of an aluminum anode of a valve in operation be examined with a microscope, no sensible modification of the surface can be observed. The formation of the film is too thin to be noted.

Electrostatic Capacity of Valves.

The writer has measured the electrostatic capacity of a valve whose surface had but 1/10 of a sq. mm extent, and which was charged to a difference of potential of two volts during a period of less than 1/100 second. The capacity found was from 7 to 10 microfarads. These capacities correspond to values of 700,000 to 1,000,000 microfarads per sq. decimeter. With surfaces of aluminum a decimeter square the observed capacities are no more than a farad for 10 sq. meters, that is to say 1000 times less than the preceding. For a given surface the capacity diminishes very rapidly with the time of charge, as a result of the proportional augmentation of the thickness of the film. The charging of the condenser continues during an appreciable time varying from 1/10 to 1 second. In the case of the largest capacity observed, the thickness of the dielectric is of the order 10^{-7} , that is to say of molecular magnitude.

Electrolytic Condenser.

A condenser of large capacity and instantaneous effect can be obtained by using broad sheets of aluminum in a solution of ammonium phosphate. The surfaces of the aluminum should undergo a long preliminary formation.

Rectification of Alternating Currents.

One of the principal applications of the valves consists in the rectification of alternating currents. The writer will review here the investigation he has made of this subject.

Influence of the Electrolyte.

Consider the influence of an electrolyte upon the constants of a valve in the following table where:

U = effective e.m.f. of the alternating current measured with a thermic voltmeter.

U_n = effective e.m.f. of the rectified current.

U_c = e.m.f. measured with a voltmeter of the magnetic or d'Arsonval type.

I = alternating-current strength measured with a thermic ammeter.

I_o = rectified current strength.

T = temperature in degrees C.

INFLUENCE OF ELECTROLYTE.

Electrolyte.	Alternating.			Rectified.		T.
	U.	I.	U _c .	U _n .	I _o .	
Biphosphate of ammonium	105	6.3	38	42	5.6	85
	108	6.7	37	43	5.6	75
Neutral phosphate of ammonium...	108	6.1	37	41	5.45	23
	104	6.7	38.5	43	5.70	70
Double phosphate of sodium and ammonium	111	7.5	39	48	5.8	23
	109	7.6	41.5	47	6.3	60
Double phosphate of potassium and ammonium	108	6.1	36	40	5.2	35
	107	7.3	39.7	45	5.9	87
Phosphate of ammonium and zinc..	104	6.7	3.8	48	5.0	25
	104	7.3	3.6	45	5.4	60
Biphosphate of sodium	106	8.2	31	52	4.6	25
	108	11.7	16	73	2.6	69
Neutral chromate of ammonium....	106	7.5	36.5	48	5.3	25
	110	8.7	35	55	5.3	52
Double chromate of ammonium and aluminum.....	110	98	33	57	5	23
	108	102	31	62	4.7	66

The following may be deduced from this table:

1. The rectification is complete up to about 30 deg. C. The leakage increases thereafter up to the boiling point.
2. Ammonium salts give the best results.
3. The addition of another salt to the ammonium salts diminishes the valve effect.
4. Neutral ammonium phosphate of all the ammonium salts is that which gives the most complete results.

Arrangement Adopted.

From the results noted above it is to be concluded that the best practical arrangement for an electric valve consists of:

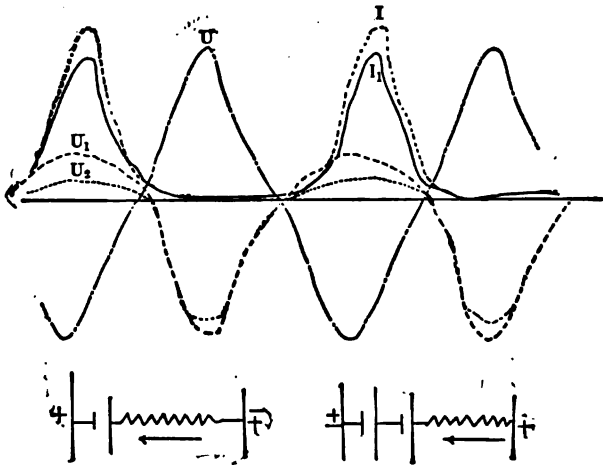

FIG. 1.

1. An anode of aluminum alloyed with a small proportion of a foreign metal.
2. A cathode of lead of larger surface than the anode and capable of formation.
3. A concentrated solution of neutral ammonium phosphate.

Wave Form of the Rectified Current.

A valve containing a concentrated solution of double ammonium and sodium phosphate was investigated by means of an ondograph. The curves are plotted in Fig. 1, in which

U = alternating current whose effective e.m.f. = 100 volts at a frequency of 42 cycles.

U' = e.m.f. at the two outside terminals of the valve = 82 volts.

U_r = effective e.m.f. between the terminals of a single valve = 73 volts.

I = strength of current with one valve = 3 amperes.

I' = strength of current with two valves in series = 2.6 amperes.

An examination of these figures shows:

1. The direct current is manifested only during each half cycle of the alternating current.
2. The e.m.f. and the current are dephased with reference to the alternating potential difference.
3. The current strength is weaker with two valves in series than with one.

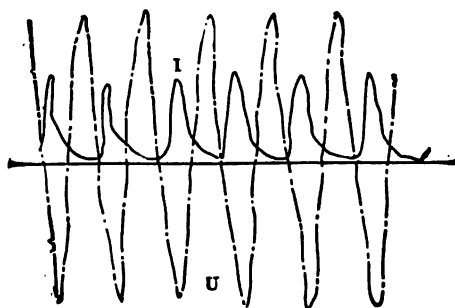

FIG. 2.

4. The rectification in the particular case above (double ammonium and sodium phosphate) is rendered more perfect by the use of two valves in series.

An examination of a large number of tables results in the conclusion that the form of the curve of the e.m.f. varies with the nature of the electrolyte, that the dephasing of the rectified current varies according to the inductance of the exterior circuit.

Magnesium Valve.

Fig. 2 shows the phase displacement of the current with reference to the potential difference. The valve is made of an anode of magnesium, a cathode of graphite, and an electrolyte of ammonium fluoride.

Difference of Potential at the Terminals of a Valve.

Fig. 3 is obtained with a valve made with an anode of pure aluminum, a cathode of surface about 100 times as great, formed of aluminum alloyed with 10 per cent copper, and with an electrolyte of ammonium carbonate.

V' = difference of potential between terminals of valve on open circuit = 69 volts.

U = difference of potential in operation = 89 volts.

I = strength of rectified current = 1.3 amperes.

Influence of the Nature of the Cathode.

Graphite used for the cathode disintegrates slowly. Iron becomes coated with an adherent coating of iron phosphate and alumina, which increases the resistance. A sheet of polished steel is but slightly attacked. Lead becomes covered with lead

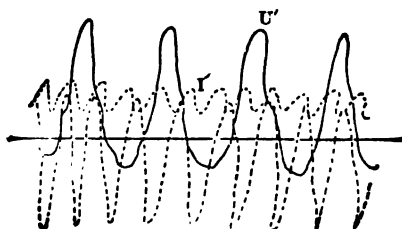

FIG. 3.

peroxide which protects the metal. The alloys of aluminum containing from 8 to 10 per cent copper and 5 per cent nickel suffer no sensible attack, but the output is less than with lead or steel.

Condensation at the Opening of the Valves.

In a single valve of aluminum the electrolytic hysteresis has a value higher than unity with the alternating current. The persistence of the film of dielectric, during a portion of the inverse half cycle, results in very noticeably augmenting the internal resistance of the cell.

Influence of Self-Inductive Circuit.

It may be demonstrated that the effective current, I_{eff} , of an alternating current must be equal to the ratio existing between the potential difference, V_{eff} , between the plates of a condenser and the

ohmic resistance, R , of the exterior circuit, $I_{\text{eff}} = V_{\text{eff}}$. In this particular case when this effect is obtained, the angle of dephasing between current and voltage is zero, and the phenomena occurs as if there were neither condenser nor self-inductance. If a valve, the capacity of which is known, be connected in series with a corresponding self-inductance, the graph indicates that more dephasing is necessary. This result is readily obtained with small outputs.

Transformer and Rectified Current.

The current from a single valve, when fed to one winding of a transformer, causes the latter to furnish an alternating current from the other winding.

Rectified Currents and Electric Motors.

Pulsating rectified current given by a single valve produces considerable induction results in series or in shunt excited motors,

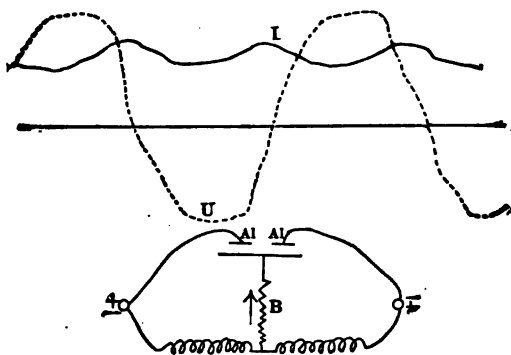

FIG. 4.

from which there results a poor mechanical output, a rapid heating and sparking at the commutator. The operation of magnets is much more satisfactory.

Double Anode Valve, Connected as a Bridge, and with Two Resistances with Opposed Self-Inductances.

In the arrangement of apparatus indicated in Fig. 4 the cathode is connected with the exterior resistance A which itself is in circuit with two resistances of self-inductances S and S' equal and opposed. Two anodes, A_1 , A_2 , of aluminum placed in the valve with the

cathode are connected with the two terminals of the alternating source. The rectified current in the operating circuit is slightly undulating, its strength $I = 10$ amperes, its e.m.f., $U = 55$ volts. The alternating potential difference = 110 volts.

In order to use both half cycles of the alternating current, four valves may be employed connected as in a Wheatstone bridge. An examination of this arrangement shows that each half cycle of the current will always traverse two valves connected in series and that the two successive half cycles are rectified in one direction and that they add their effects upon an exterior circuit. The regulation

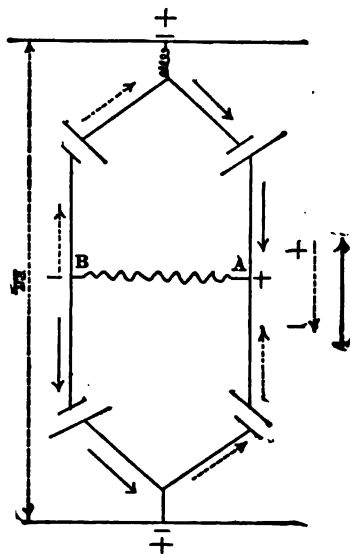

FIG. 5.

of the output is effected by means of reactances of variable self-inductance and the output of the valves is limited by the cutout fuses. The loss of energy effected in the valves is manifested in the form of heat. The apparatus grows warm, and it is necessary to maintain it at a constant temperature of between 30 deg. and 40 deg. C. by means of external refrigeration. According to the output of the valves there may be utilized for this refrigeration external radiation, a cold current of air, or a cold current of water. In the latter case the four valves are to be carefully insulated from the water. The model of the valve most in use is that constructed by Mors & Company of Paris.

This valve is composed in its essentials of a prismatic vase of lead, of plate form, constituting the cathode. The vase is surrounded by sheet iron forming its support. The anode is an aluminum alloy assuming the form of thin plate laminated at the edges, upon which is fixed a rod of aluminum forming the lead for the current. This rod is insulated by means of a tube of rubber. The valves contain a saturated solution of neutral ammonium phosphate. Cooling is accomplished by means of a lateral electric ventilator. The Mors Company constructs standard sizes between 1 and 100 amperes at 110 volts, whose operation is regular and constant. The guaranteed industrial efficiency of these valves varies between 65 and 75 per cent.

Curves Obtained from Such an Arrangement.

In Fig. 6 it will be seen that an alternating current under an alternating e.m.f. of 117 volts, at 53 cycles, furnishes a

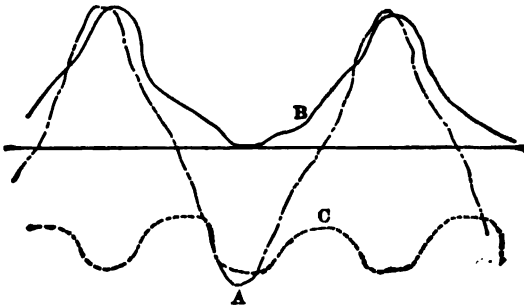

FIG. 6.

rectified current at an e.m.f. of 82 volts. The strength of the alternating current is 5 amperes and that of the rectified current 4.5 amperes. The output of the valve is not high, but this figure possesses a certain interest, for it has been obtained with valves made with cathodes of polished steel plunged in a solution of neutral ammonium phosphate, maintained at a constant temperature of 9 deg. C. The apparatus has operated continuously and has carried 3800 ampere-hours. At the commencement of operation of a new valve, the e.m.f. is equal to 96 volts for the rectified current (110 volts alternating). This e.m.f. soon drops to about 80 volts, where it remains constant. The leakage is very slight under normal conditions.

The nature of the electrolyte plays an important part in the valves. This action, in the case of a single valve, has already been examined. Determinations made with a valve set up as a Wheatstone bridge show the great superiority of neutral ammonium phosphate over other salts.

The division of the anode produces a perceptible lowering in the efficiency. The partitioning of the cathode affects the efficiency but little. If the leakage be zero at 20 deg. C. it will be noted that at 27 deg. it begins to show, and that at 75 deg. it becomes very important.

Effect of Inductive Circuits on the Rectified Current.

For a weak current varying from 0.1 to 0.5 amperes the self-inductance of the circuit shows the effect of the capacity due to the valves, the dephasing ceases to be produced and the e.m.f. of the

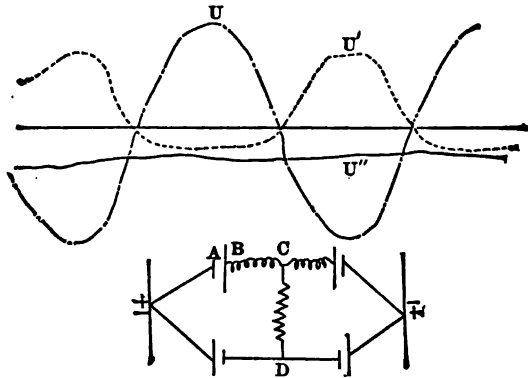

FIG. 7.

rectified current is raised. With an inductive circuit arranged within the same mounting in a Wheatstone bridge, the effects produced upon the capacity of the valves are energetic. Fig. 7 shows the effect produced with U = alternating difference of potential, U' = the e.m.f. of a single valve, with inductive circuit, and U'' = the e.m.f. at the terminals of the inductive circuit.

Electrolytic Condenser.

In arranging a series of aluminum sheets in a bath of ammonium phosphate an electrolytic condenser is secured of large capacity and whose discharge is instantaneous on opening the circuit.

The valves when connected in parallel with this condenser give a current of barely undulatory shape.

The Lowering of E.M.F.

The causes of the decrease in e.m.f. of the valves may be summed up as follows:

1. Ohmic resistance produced at the opening of the valves by the film upon the anode.
2. Ohmic resistance of the film at the cathode.
3. Effects of static charge during the periods of opening and closing.
4. Non-uniform composition of the anode.

Electric Motors.

Electric motors, when operated by this current, behave in a manner similar to that considered in connection with a single valve. Motors, with their field magnets excited by current from a storage battery, operate excellently and give a high efficiency

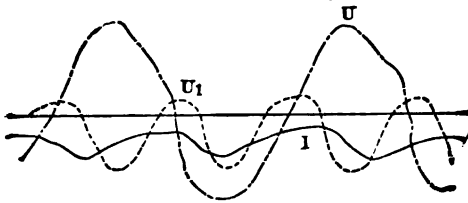

FIG. 8.

as a result of the absence of the inductive influence of their field coils. Such motors should have their iron parts finely laminated, as in the Rechniewski motors, in order to obtain this result. Fig. 8 shows the behavior of a small Edison shunt-wound motor. I is the current, U the alternating potential difference, and U_1 the e.m.f. of the rectified current. The current shows itself as a flat curve, but the e.m.f. cuts the axis at each half cycle. There results a lowering of the efficiency and sparking at the brushes.

Storage Batteries on Rectified Currents.

A lead accumulator can be compared to an electrolytic condenser of large capacity in which the charge disappears as fast as

it flows in and is reproduced as it flows out owing to internal chemical reactions. Considered in this way, it will be seen that the accumulator, with current rectified by valves, can produce an effect analogous to that of an electrolytic condenser. The chemical reactions operative during the charge being produced effectively only between fixed limits of e.m.f., it is advisable

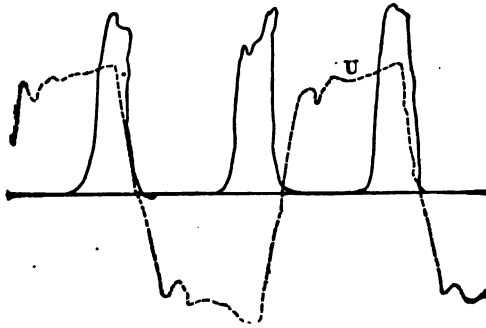

FIG. 9.

to lower the maximum ordinate of the rectified current to the conditions of effective operation at the accumulator. When the charging current has a very undulatory wave-form (Fig. 9) there will be noticed an abundant liberation of gas at the battery electrodes; and the efficiency of discharge will not exceed 50

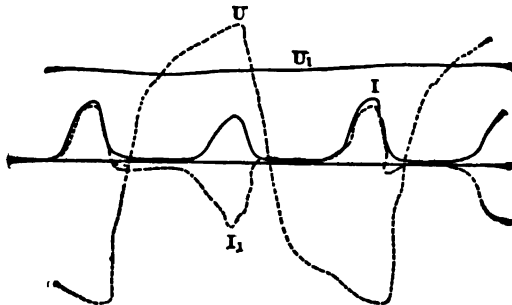

FIG. 10.

per cent. I = rectified current strength; U = alternating e.m.f. It will be seen on the other hand in Fig. 10 that the maximum ordinate of the rectified current does not exceed the value necessary for the charge.

U = alternating e.m.f. = 119 volts.

U_1 = e.m.f. of rectified current = 102 volts.

I = alternating current strength before entering valves = 10 amperes.

I' = strength of current in battery = 9.5 amperes.

The efficiency is then practically the same as with continuous currents. The storage battery can further be used as a condenser. A derived current is taken from the terminals of the battery while it is charged with a single valve. A consideration of the results leads to the conclusion that with a battery of low capacity and with as low an internal resistance as possible, a practically continuous discharge current may be obtained.

Rectification of Polyphase Currents.

Two-phase or three-phase currents can be rectified by means of the valves. By an arrangement of apparatus similar to that of the Wheatstone bridge, but using six valves, a practically continuous current may be obtained. A special arrangement can also be used which consists of a single cathode and of two or three anodes dipped in a solution of ammonium phosphate. The rectified current pulsations, which correspond to the successive half cycles, are then utilized in charging a battery of small capacity and low internal resistance. The current obtained at the terminals of the battery is practically rectilinear.

Induction Coils.

These will operate with current which has been rectified by means of four valves. A rotary interrupter is then employed. Rochefort has investigated a special model which uses a single valve, of variable capacity and internal resistance, connected to a rapid interrupter. The induced currents obtained by means of these devices can be advantageously employed for radiography or for wireless telegraphy. When a valve is used with small anode surface and a strong current it operates in a manner analogous to the Wehnelt interrupter. The result obtained is the same as with continuous currents. It seems probable that the Wehnelt effect is an effect of electrolytic capacity analogous to that of the valves.

Efficiency.

This has been determined by Hospitalier (*Industrie Electrique*, 263, Dec. 10, 1902). The energy efficiency of the Nodon valve varies from 65 per cent to 75 per cent, according to the operating conditions.

CONCLUSION.

Electrolytic valves are capable of being used in many ways in the laboratory and industrially. These instruments allow of securing oscillatory currents by direct and simple methods, such as are used with continuous currents. The operation by their means of high-potential alternating-current transformers may be of great service. The employment of electrolytic condensers of very high capacity may be useful in a great many investigations and industrial pursuits. The valves are actually in common use in charging accumulators and in the operation of small electric motors upon alternating-current circuits. The efficiency is greater than with small rotary transformers, their care is more simple and their maintenance is practically nothing.

DISCUSSION.

CHAIRMAN STEINMETZ: By electromagnetic induction we cannot produce a unidirectional e.m.f., and thus a direct current, in a closed circuit. Since the magnetic flux enclosed by a closed circuit can not continuously increase or decrease, any line of magnetic flux, which in entering a closed electric circuit induces an e.m.f. therein, must in a finite time induce an e.m.f. in the opposite direction by leaving the closed electric circuit. An electromagnetically induced direct e.m.f. can thereby be produced only in an open circuit; that is, in a circuit in which either one part of the circuit slides over another part, as in the unipolar or nonpolar machine, or a part of the circuit reverses the terminals relatively to another, as in the commutating and rectifying machine. But it follows that in a stationary circuit a unidirectional e.m.f. can not be induced. Hence devices are important whereby from an alternating e.m.f. a more or less unidirectional current can be produced. Such devices have been variously called electric valves, etc. They are devices permitting the flow of current more freely in one direction than in the reverse direction; or, in other words, giving an effective resistance which is greater in one direction than in the other, or in an extreme case, which is low in one direction and infinite in the reverse direction, thus resulting in complete rectification. Such asymmetrical conductors, so far as I know, are not found in the first class of metallic conductors, but they seem to be in some way or other connected with, or associated with, the existence of a discontinuity of potential at the boundaries of the conductor, or at the elec-

trodes. We find such heterogeneous conductors among the electrolytes and among the gaseous conductors, the arcs. Electric rectifiers, valves, effective condensers, and other applications of this phenomenon, we find, then, amongst electrolytic devices and amongst arcs. The rectifying action of the electric arc and phenomena connected therewith I believe will be discussed at a meeting of Section E, which is the section devoted to electric lighting. The present paper deals with a form of rectifier in which rectification is produced by an electrolytic conductor. The paper contains an experimental investigation in which Mr. Nodon observes the effect of a variation of electrode material, finding that aluminium, and next to it magnesium, are the best electrode materials. Then investigating the electrolyte, he finds that ammonium salts give the best results, and amongst them ammonium phosphate, in concentrated solution.

If there is no further discussion of the electrolytic rectifier of Mr. Nodon, we will proceed to the next paper on the programme, which is, "The Testing of Alternating-Current Generators," by B. A. Behrend. I will call upon Mr. Slichter to give us a short abstract of this paper.

THE TESTING OF ALTERNATING-CURRENT GENERATORS.

BY B. A. BEHREND.

The starting point of improvement of engineering apparatus is an exact knowledge of its properties. It is only after learning the characteristics of a machine that we are placed in a position to judge where improvement is necessary, and how it can be accomplished. In order to know whether improvements have been effected, it is essential to possess some methods of testing, which furnish us a criterion of whether the improvement is real or imaginary. The numerous claims of inventors describing improvements in electrical apparatus are rarely put to test, and many of these improvements are rather fabrics of the inventor's imagination than actual improvements.

It is thus that the aim of the engineer whose work consists in designing and creating new apparatus is directed towards means for the accurate determination of the characteristics of his machines, and improvements in the methods of testing are hence synonymous with improvements in the apparatus itself.

The design of alternating-current machinery has been a slow process of evolution. At first a subject dark and poorly understood, sound theory and experiment have lighted it up so that from the uncertain groping in the dark, the design of large power units has become a matter of scientific calculation based on a vast amount of empirical data gathered from careful and elaborate tests, generally made under difficult circumstances with care, devotion, and sacrifice on the part of the engineers, which are a credit to, and an ennobling feature of, the engineering profession.

The subject of this paper is a description of an improved method devised by the author for testing alternating-current generators and synchronous motors, under full-load conditions, without actually having to place the machines under full load. It is not possible with the large sizes of units of the present day to supply the driving power for test required at full-load and at over-load, and, there-

fore, methods of test have to be devised in which the driving power is limited to the power available in the shops of the manufacturer. The machines must be put under conditions such as lead to full losses in the core and the coils of the machines.

The alternating current by means of its property of being able to store energy during one-quarter of a period, and return it during the next quarter, allows the flow of large amounts of apparent energy in the form of so-called wattless currents. It is possible, by properly exciting two alternating-current machines operating in parallel, to circulate a large quantity of apparent energy without having to supply more true energy than corresponds to the losses which take place in the machines. Such motor-generator tests, consisting in operating one alternating-current machine as a motor, running idle, have been made by the author for many years, and have been used for the determination of the regulation of alternators on low power-factors, as well as of the heating under the same conditions.¹

But this method of testing requires two machines of the same capacity and involves the expenditure of power corresponding to the losses of two machines. The first to suggest the circulation of power within a single machine was Mr. William M. Mordey in a paper, Volume II, 1893, of the *Journal* of the British Institution of Electrical Engineers. Mr. Mordey's method applied, for instance, to a single-phase generator, having twenty poles on each side of a single exciting coil, would be carried out by splitting the armature into two sections of eight and twelve coils respectively, and by connecting these sections in opposition so that only four coils would be effective in regard to the circulation of current through the armature. The section of the armature which contains eight coils acts as motor, while the section containing twelve coils acts as generator. The current which circulates through the armature coils is almost in quadrature with the resultant e.m.f., and is, therefore, a wattless current. Hence, the eight poles of the motor-section of the

1. See the author's paper, *Electrical World and Engineer*, New York, 1900, January 20, 27, February 3, on "The Factors which determine the Design of Single-phase and Multiphase Alternators."

L'Eclairage Electrique, Paris, 1900, page 140, "Sur le Calcul des Alternateurs."

Transactions A. I. E. E., May 19, 1903, "The Experimental Basis for the Theory of the Regulation of Alternators."

machine will be strengthened by the armature current, whereas the twelve poles of the generator section of the machine will be weakened by the same current. This leads to a magnetic unbalancing of the machine, as the motor fields carry more resultant flux than the generator fields. In Mordey's machine, this condition may not have caused trouble, as his machine does not contain iron in the armature; but in modern generators his method cannot be used on account of the magnetic unbalancing of the machine. Instead of dividing the armature into two sections, and connecting these sections in opposition, it naturally suggests itself, especially on poly-

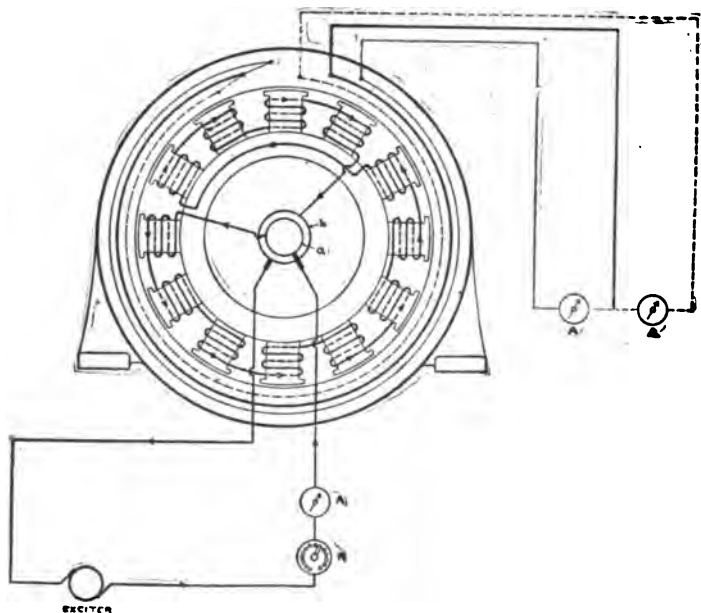

FIG. 1.— DIAGRAM FOR MORDEY'S COMBINATION OF FIELD COILS FOR CIRCULATING POWER TEST.

phase machines of the revolving field type, to split the field into two sections and to connect these sections in such a manner that the e.m.f.'s induced in the armature are in opposition. This method cannot be carried out in practice as the machine vibrates and jars in a manner which makes its operation under such conditions impossible.

Referring to Fig. 1, which represents Mordey's combination of field coils, we see that the current in the armature strengthens the

field of the poles which act as motor and weakens the field of the poles which act as generator, as represented in Fig. 2. The magnetic attraction between the revolving and stationary parts being proportional to the square of the induction in the air-gap, we see at a glance from Fig. 2, that the conditions of operation are impossible, on account of the unbalanced magnetic forces. In order to circulate power successfully within a single machine, it is thus essential to obtain uniform induction in the air-gap of both the motor and the generator poles. As the armature reaction strengthens the motor

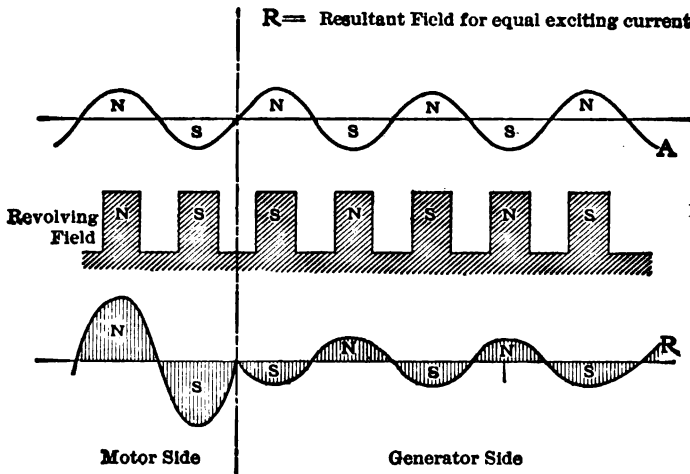

FIG. 2.— DIAGRAM SHOWING EFFECTS OF ARMATURE CURRENTS IN MORDEY'S TEST.

poles and weakens the generator poles, the impressed excitation of the motor poles must be smaller than the impressed excitation of the generator poles, and this can be effected as shown in Fig. 3, by splitting the field-coils into two sets of an equal number, excited with different field currents. Fig. 4 shows the effect of the armature reaction on the poles. Both in Figs. 2 and 4, the wavy line A represents the field produced by the armature current alone, and the wavy line R represents the resultant magnetic field.

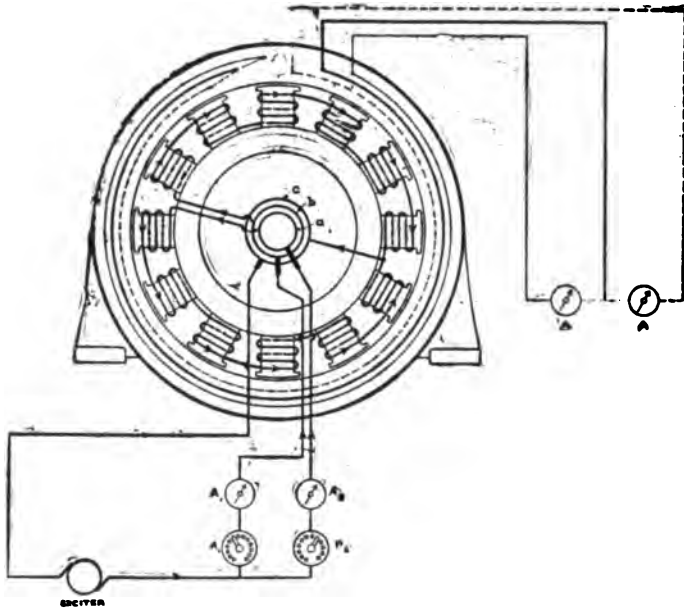

FIG. 3.— DIAGRAM FOR THE AUTHOR'S COMBINATION OF FIELD COILS FOR CIRCULATING POWER.

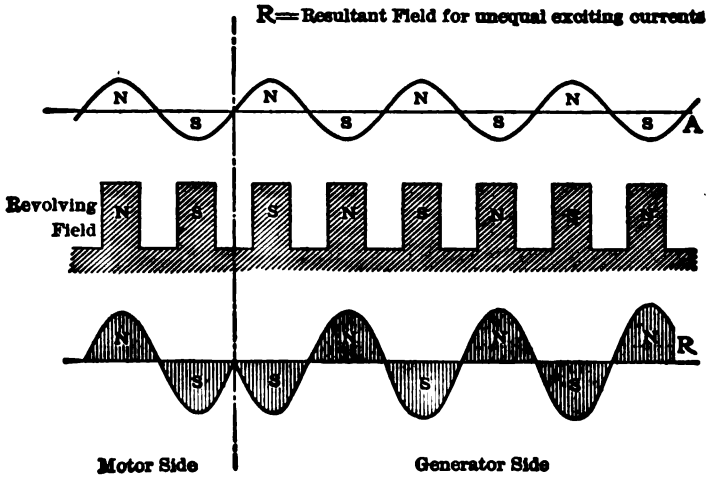

FIG. 4.— DIAGRAM SHOWING EFFECTS OF ARMATURE CURRENT IN THE AUTHOR'S SPLIT-FIELD TEST.



FIG. 8.— 3000-KW ALTERNATOR.



FIG. 9.— 3500-KW ALTERNATOR.

DETERMINATION OF THE REGULATION OF ALTERNATORS.

Fig. 5 represents the regulation curves on low power-factor obtained by first running a synchronous motor from the generator and secondly by circulating power within the machine itself. The agreement between the two methods is very satisfactory. Numerous experiments have been made on machines designed by the author to check the new method against the synchronous motor generator tests, and the results have shown a very close agreement.

Fig. 6 shows the regulation curves of a 3000-kw, 26-pole, 50-cycle generator, obtained in this manner. Fig. 8 shows a picture of this machine. Fig. 7 shows the regulation

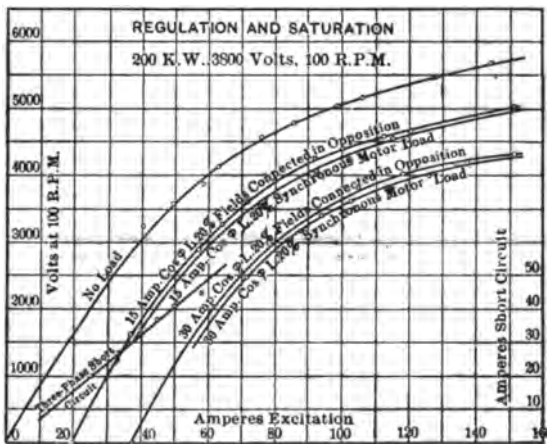
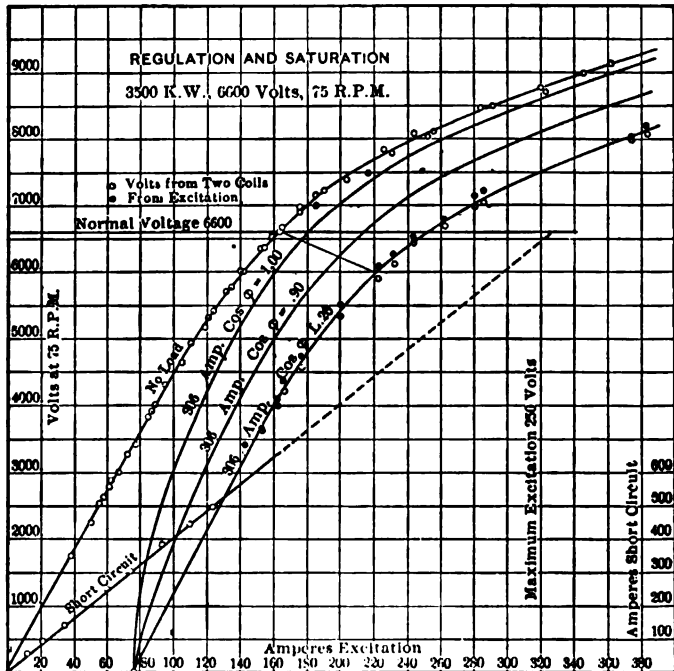
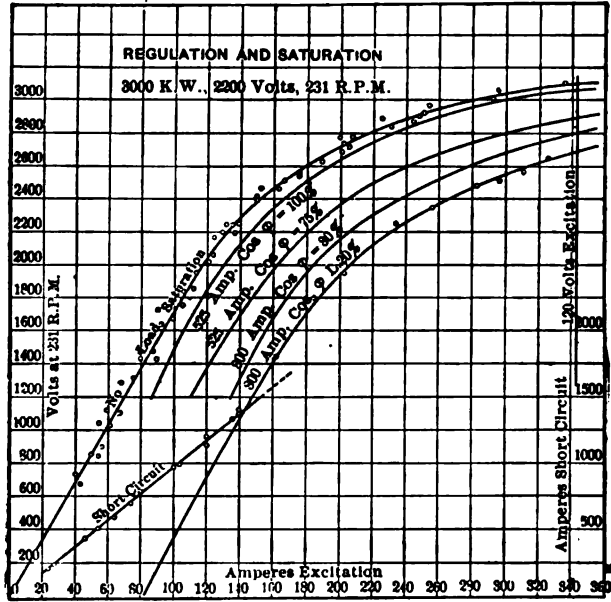

FIG. 5.—COMPARISON BETWEEN REGULATION CURVES OBTAINED BY SYNCHRONOUS-MOTOR-GENERATOR TEST AND BY THE AUTHOR'S METHOD.

curves of a 3500-kw, 40-pole, 25-cycle generator supplying power to the World's Fair at St. Louis. Fig. 9 shows a picture of this machine. Fig. 10 shows the regulation curves of a 3200-kw, fly-wheel type, 96-pole, 60-cycle generator. The terminal voltage corresponding to the conditions under which the machine is operating in the test can be determined, either by measuring the volts on a set of coils per pole multiplied by the total number of coils; or, by adding to the excitation on the motor fields the excitation required to drive the armature current through the armature winding. Both methods have invariably given the same results.



FIGS. 6 AND 7.—REGULATION CURVES OBTAINED BY THE AUTHOR'S METHOD.

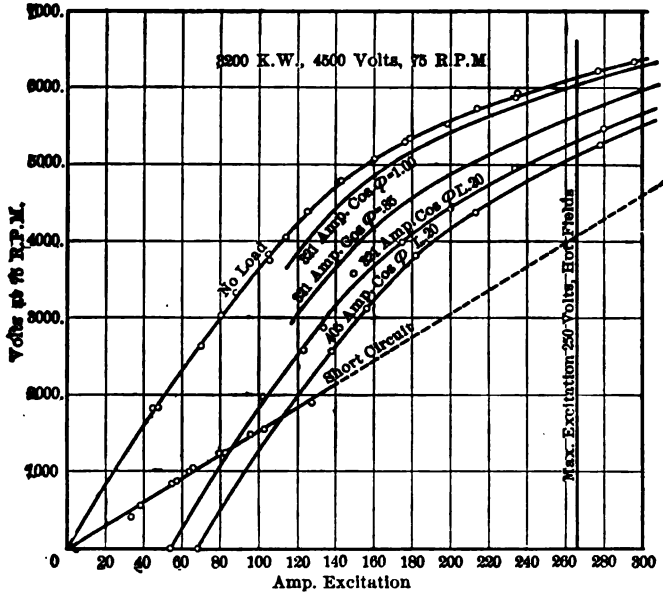

Fig. 10.—REGULATION CURVES ON A 3200-KW ALTERNATOR OBTAINED BY THE AUTHOR'S METHOD.

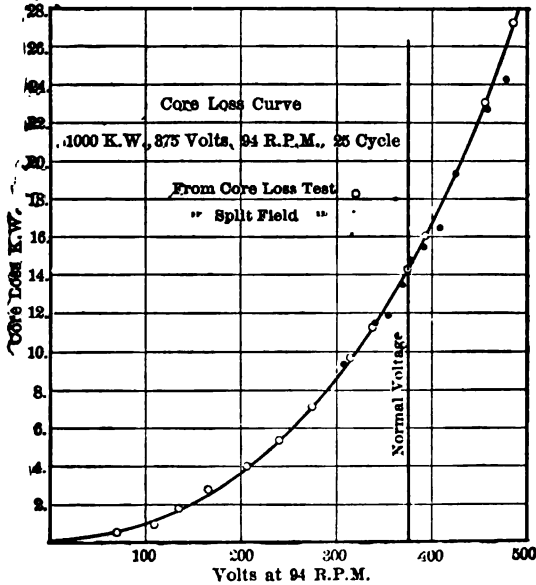

Fig. 11.—COMPARISON OF CORE-LOSSES OBTAINED ON OPEN CIRCUIT AND IN THE AUTHOR'S SPLIT-FIELD TEST.

DETERMINATION OF HEATING.

Numerous tests have been made to ascertain the actual losses in operating the machine in the manner described by splitting the field. Fig. 11 shows the comparison between the core-loss of the machine, as determined in open circuit run, with losses as obtained in the split-field test. These tests were carried out on a 1000-kw, 25-cycle, 32-pole generator.

The heat runs obtained by this method on the machine represented in Fig. 9 and on a 3200-kw machine, at full normal load in kilo-volt-amperes and power-factor zero yielded the following results:

HEATING TEST.			
		3500-kw.	3200-kw.
Volts		6600	4500
R.P.M.		75	75
Frequency		25	60
Hours		18	23
Load K.V.A.		3500	3870
Temperature Rise Degrees Centigrade	{ Armature Surface	30°	27.5°
	{ Armature Coils	34°	31.5°
	{ Field Coils	34°	31.5°

It is hard to imagine a simpler method of testing than the new method described. The course of evolution in engineering has always been from the complex towards the simple. It has taken many years to evolve this method of testing which enables us to obtain with comparative ease the most important data of the performance of alternating-current generators. The only draw-back of the method consists in the fact that it is applicable only to machines having a comparatively large number of poles. It has not been successfully applied to machines having fewer than eight poles. The application of this method is confined to machines of the slow-speed type, and with the advent of the steam turbine generator, new methods will have to be devised to produce artificially full-load losses without the expenditure of full-load power.

DISCUSSION.

PROF. RYAN: The paper, it seems to me, Mr. Chairman, outlines a splendid method for attacking the problem, but I am not prepared to discuss the subject further. I am sure there are gentlemen among us who have had large experience in our factories in handling matters of

this kind, from whom we should all like very much to hear. The plan of securing results by this method occurs to me as one wherein those excellent values and quantities can be obtained that are necessary for the proper acceptance of machinery, alternating-current generators, under the conditions of sale and of original specification. Speaking for myself, I should indeed like to know of the experience of those in practice as to the manner in which they believe a method of this kind will clear up for us a line of information that we need so much today in the technology of the alternator, that will assist us to predetermine the performance of the alternator in design. The method outlined in the paper is undoubtedly a splendid one for determining the facts that are needed for the acceptance of machinery commercially.

Mr. W. L. WATERS: Mr. Behrend's method is a very convenient one for testing large alternators, but it has the disadvantage that it necessitates temporary false connections on the rotating field magnets. It appears probable that the test would give accurate results as regards the temperature test, but it is by no means certain that with the changed conditions we would get accurate results in regulation test. It is useless to argue about such tests from a theoretical standpoint. The only decisive test of such a method is a comparison of the results of the test on a number of machines with the results obtained on the same machines from a direct test. Mr. Behrend gives comparative tests on one or two machines and the method shows up well, but before definitely accepting the method as accurate, we should require similar tests on a much larger number of machines.

I think a temperature test on a large alternator is very easily made by connecting the armature coils so that there is no resultant potential difference at the terminals and then fully exciting the magnets and sending a direct current through the armature coils. This method has been found to be accurate as regards the armature; but it gives a somewhat greater temperature rise on the magnets than we would get under normal conditions, on account of the currents induced in the magnet coils by their motion through the magnetic field caused by the current in the armature. This test is a more convenient one than Mr. Behrend's, as it requires no false connections on the rotating part of the machine. Mr. Behrend criticises this method on account of the mechanical stresses to which the machine is subjected on the test. I think Mr. Behrend exaggerates these stresses. There certainly are stresses, but unless the machine is weak mechanically they are not likely to do any damage. I recently ran this test on a 1500-kw machine and though there was considerable vibration we were not at any time afraid of doing damage to the alternator.

As regards regulation, it is undoubtedly best to guarantee this for a low power-factor load rather than for power-factor 1. The best way is to guarantee for power-factor zero, and then even in the case of large units, a direct test can be made. The machine can be loaded up on self-induction coils which have a power-factor of about 0.1, quite easily, and then we obtain a full-load regulation test for the alternator under the worst possible conditions as regards power-factor, and we have a test which is not open to suspicion as being based on arbitrary assumptions.

Such a set of self-induction coils can be made water cooled and can be made quite easily to handle a 2000-k.v.a. load for a short time. And, the power required for the test being quite small, such an outfit is a convenient and useful addition to any testing room.

Mr. E. KILBURN SCOTT: I remember very well the first machines which Mordey tested in this particular way; because at that time, about 1892, I was with the Brush Electrical Engineering Company. My recollection of the reason for the particular method being developed was that the firm was making much larger machines than they had ever attempted before, and had not sufficient boiler and engine power for driving them at full load. I can tell you that the purchasers did not accept the figures so obtained, and fortunately, too; for when the machines were tested afterwards, coupled to their engines in the station—it was a London station—results were very different, not to say indifferent. I do not know of the method having been tried on a machine with an iron-core armature, and I think it would not do at all for that type. I may mention that the diagram shown in the paper is not quite correct for a Mordey machine. The Mordey alternator had a single-coil field, and the armature coils were connected out of balance. In the diagram the coils are shown on each pole.

Mr. D. B. RUSHMORE: May I state a few of the methods actually used in testing alternators for temperature rise under different conditions of load. The parts of the armature circuits are often divided unequally and bucked against each other. By doing this carefully, the full-load excitation will send full-load current through the armature, the iron at the same time being worked at its proper density. The armature may be short-circuited and the field connected in two parts, the number of poles in one being greater than the number of poles in the other; and these two parts connected in series but with the connections reversed for one. With the machine possessing a considerable number of poles, very close to the normal conditions may be obtained in this way. With inductor alternators, the halves of the phases are connected in opposition; the phases are then connected in series, and direct current is forced through the armature, while the field is excited with normal current.

With regard to the methods for obtaining the necessary data for regulation, the methods principally used are those which depend upon the no-load saturation curve and the short-circuit characteristics, these being the ones which are easily obtained in use. The results obtained are then used for calculation either in the m.m.f. or reactance methods. For a given type of machine, the error of these methods is usually known with a fair degree of precision. There are, of course, other and more refined methods for calculating the regulation and these are often used in the designing office, especially for predetermination, but for commercial testing the ones given above are generally employed.

Mr. E. KILBURN SCOTT: If I might continue, the objection to any method of this kind is that when you are driving by a steam engine, the engine itself gives off a good deal of heat which finds its way to the armature and field-coils. Testing a generator in an isolated way in the workshop does not take any record of such outside influences. Another

thing is that the engine, or prime mover, may be subject to vibrations and uneven turning. In the Mordey alternator, for example, it was difficult to keep the field poles from touching the armature coils. I remember one particular machine in which we had to widen the air gap twice, and these faults were only found out when the machine was actually tested in the station driven by its own engine.

CHAIRMAN STEINMETZ: My experience with the testing of very large machines has been that the only entirely unquestionable way of determining the full-load heating of the machine is to run it at full load, and the only entirely unquestionable way to get the regulation at full load, is to measure the regulation at full load. This, however, with the sizes in which machines have now come to be made is impracticable, since either not sufficient power is available to run the machine at full load, or at any rate, even with the largest manufacturing companies, there is not sufficient power available to test all the large machines which are being produced, at full load, for a sufficient length of time to get the final temperatures. Compromise tests have, therefore, been introduced which give more or less accurately the regulation and the temperature rise within that range of machine types which have been the basis of formulating the conditions of test.

Now, Mr. Behrend gives us here one method by which you oppose a number of field poles to the remaining field poles and by using for the field-exciting current a certain value, and using a certain number of opposing poles in proportion to the number of direct poles in the circuit, based on previous experience, you can arrange the test so as to get the right heating, the correct rise of temperature. But, as you see, you have to know at the outset how to arrange the test to get the right results. So, after all, it is merely an abbreviated method which stands or falls with your previous experience with similar types of machines, but which necessarily leads to wrong results if directly applied to machine types very different from those on which the method of test and the numerical arrangement of the test has been derived. The method of testing for heating of large alternators now used by the General Electric Company is still more radical. The machine is run under short circuit, and at an overload of current, and then an open circuit with over-excitation for a definite period of time, and by choosing proper load of current and proper excitation, you get the right temperature rise. After all, this only amounts to an application of the same method which is standardized for determining efficiencies, to the determination of heating. Just as the individual losses are determined separately and then combined to get the total loss, and hence the efficiency, so the heating due to the armature current, that due to the core-loss, etc., are determined separately, and then combined to get the total heating of the machine.

Now, the same applies to the test for the regulation. The most reliable method of determining regulation which we have found is to calculate from the no-load tests, on open circuit and on short circuit, which latter is essentially the regulation test on a zero power-factor. This calculation, while there may be some theoretical errors in it, can be made so as to be much more accurate than the direct observation of the regulation on

noninductive load, considering that the test at full noninductive load is not an easy test to make. It is very difficult, since the engine varies in speed, the steam varies in pressure; the load is not as absolutely constant as you can get it in the laboratory when you are testing a small machine driven by a motor and maintaining constant speed. Now, you can not do that in testing an alternator directly connected to a 5000-kw steam-turbine, for instance. The speed will vary slightly. You can not maintain in most cases full steam pressure, constant speed, etc. And so we find that the calculation of the regulation gives really accurate values, values which agree more with the average result of practical experience in the future working of the machine under service conditions than a direct test.

PROF. ADAMS: The opinion just expressed by the Chairman as to the best method of arriving at the regulation of alternators, is very gratifying to me, as it is the method which I have for some time advocated and used with excellent results on many different types of alternators. It is essentially the fundamental method, and from it the two more familiar short-cut methods may be readily derived in such a way as to show clearly the reasons for their insufficiency. It also has the advantage of being based upon the familiar method of analysis used in connection with transformers and induction motors, which unifies the treatment of nearly all types of alternating-current machinery.

MR. S. SENSTIUS: I have had occasion to check this method of Mr. Torda-Heyman on several machines, and I found that in most instances the method gave quite accurate results. In two cases, however, where the machines were first tested according to the split-field method of Mr. Behrend, and then tested with a synchronous motor running without excitation, it appeared that the method gave too good regulation, the actually tested regulation being much worse. Now, from a good many alternators tested at zero power-factor, and also on short circuit, I found that the most reliable method for predetermining the regulation at zero power-factor was that in which you work on the basis of the short-circuit test. Professor Steinmetz in his book has given a method for obtaining the armature reaction of an alternator. If we know the number of turns on the armature, if we know the armature current and the distribution of the winding, we can get at the equivalent m.m.f. of the armature. Now, if these are the co-ordinates representing the armature short-circuit current and the field current, then, for a certain load, say so many amperes, the armature reaction, as given by Professor Steinmetz, is a certain amount. We plot this distance. This being equal to the armature reaction, the distance from this intersection to the abscissa of the field current represents the armature reactance voltage at zero power-factor. With these two quantities known, armature reaction and reactance voltage, the regulation curve is easily plotted. This method has been discussed by Mr. Bradley T. McCormick within the last four months in the *Transactions* of the American Institute of Electrical Engineers. I found it a most reliable method. It seems that the values for the armature reaction given by Professor Steinmetz are very accurate in practice.

The most difficult thing is to predetermine the reactance voltage at zero

power-factor, i. e., the voltage due to the self-induced flux between the poles, around the slots. On a good many machines I got very good results. For instance, in one case where the length of the armature was about 5 ins. and the pitch $5\frac{1}{2}$ ins., I got exactly the same results in theory and practice. Another case was presented by an alternator of exactly the same pitch and exactly the same number of slots, but of $7\frac{1}{2}$ ins. armature length; the difference between theory and practice was about 20 per cent. I have given up hope of ever obtaining a reliable method for the predetermination of the self-induction of an alternator.

CHAIRMAN STEINMETZ: If there is no further discussion we have concluded the program of this session, and a motion to adjourn will be in order. Tomorrow's session will be devoted to a joint discussion with Section F, the section on transportation. The program will consist of papers on alternating-current railway motors, alternating-current motors in general and allied subjects, and the discussion of the problem of the alternating-current railway.

On motion, adjourned to Tuesday morning, September 13, at 9:30.

The proceedings of Section B on Tuesday, 13th of September, will be found incorporated with the proceedings of Section F for that day, in Vol. III of the TRANSACTIONS.

THURSDAY MORNING SESSION, SEPTEMBER 15.

Chairman C. P. Steinmetz called Section to order at 9:45 a. m., Thursday, September 15, and opened the proceedings by announcing the paper of Prof. S. P. Thompson, entitled "The Plunger Electromagnet."

ON THE PREDETERMINATION OF PLUNGER ELECTROMAGNETS.

BY PROF. SILVANUS P. THOMPSON, F. R. S., *City and Guilds of London Institute.*

An impression seems to be abroad that the known laws of electro-magnetism do not suffice to enable the pull of the solenoid upon an iron plunger within it to be calculated, or at least that there is some obscure difficulty that prevents the design of such plunger electromagnets from being readily predetermined, so that when constructed they shall fulfil any prescribed specification as to the required pull and range of travel. The author has, however, not found much trouble in working out a set of rules for design which yield results of an accuracy quite comparable with that attained by the customary rules for the designing of electromagnets for dynamos and motors. It is believed that these will be welcomed by engineers interested in this branch of construction. Hence a brief account of them and of the principles on which they are established is here given.

To concentrate attention on the essentials of the problem consider a magnetic circuit constituted as shown in Fig. 1, where a

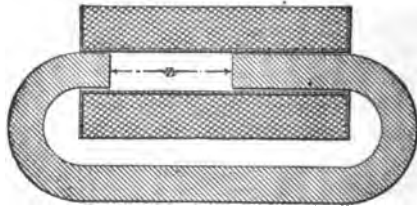

FIG. 1.

cylindrical rod of soft iron is supposed to be bent so that its ends enter a tubular bobbin carrying a magnetizing coil. Let the length of the gap between the ends of the rod be called z inches, and let the excitation be such that the flux-density along the gap, which will be practically uniform, be B lines per square inch. Let each

of the end faces of the iron have an area of A square inches. Then it is known that the pull along the gap z , tending to bring the two end faces of the iron together, is expressed by the formula

$$P = B^2 A / 72,134,000; \quad (1)$$

where P is the pull in pounds weight. It is also known that the flux-density B in the gap is related to the excitation according to the formula

$$B \times z \times 0.3133 = IS; \quad (2)$$

where IS stands for the number of ampere turns of excitation that are actually expended in driving the magnetism across the gap, and 0.3133 is the gap coefficient. If the iron is of good quality, and its magnetic state is far removed from saturation, the number of ampere-turns required to send the flux along the iron part of the magnetic circuit will be negligibly small compared with the number of those thus needed for the magnetism in the gap; and, therefore, the total number of ampere-turns of excitation to be provided by the exciting bobbin will not be sensibly greater than that expressed by the above formula. The symbol I stands for the current in amperes, the symbol S for the number of spirals or turns of wire on the bobbin. Hence we may take it that, under the above assumption that the iron is far from saturation, the actual ampere-turns needed will be $I \times S$. If the iron were so far saturated as to require a sensible additional number of ampere-turns for its magnetization, then the necessary total current would need to be slightly increased, or what comes to the same thing, the reluctance of the iron must be taken into account by adding a small equivalent length to z . In all the practical cases that arise, this increase to provide for the reluctance of the iron does not amount to more than about 2 per cent of the whole; and may, therefore, be left out of account for most purposes. The gap-coefficient 0.3133 is only another expression for the reluctivity of air expressed in inch units.¹ In other words, to drive magnetism, with a flux-density of one line

1. For those who prefer to work with metric units the formulæ will stand as follows:—

$$P \text{ in kilogrammes} = B^2 A / 24,700,000 \quad (1a)$$

$$\text{and} \quad B \times z \times 0.795 = IS \quad (2a)$$

where A is the area in square centimeters, B the flux-density in gausses, and z the gap-length in centimeters. The numeric 24,700,000 is made up of 8π and 981,000, the latter being the number of dynes in the weight of 1 kg. The gap-coefficient 0.795 is the reciprocal of 0.4π .

per square inch, along a gap 1 in. long, requires 0.3133 of 1 ampere-turn.

Let us pass from the consideration of Fig. 1, in which nothing was movable, to the case presented by Fig. 2, of an iron-clad coil provided with a movable plunger, capable of being attracted in from the right, the iron jacket being extended at the ends so as to form on the right a sort of stuffing box (lined in practice with a thin tube of copper or brass) through which the plunger enters, and on the left a face-plate, from which a short cylindrical piece enters the other end of the bobbin. The reluctance of the joints may be taken as zero, provided they have surface enough. So then, again, if the iron is far from saturation the only reluctance that need be taken into account is that of the gap between the end of the plunger and that of the opposing iron piece. Now, let it be as-

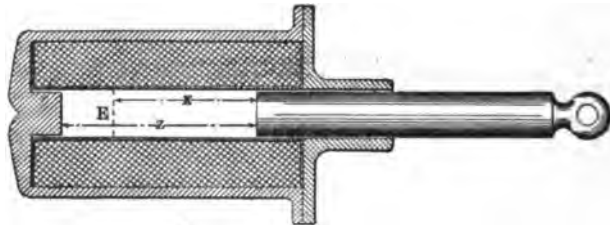

FIG. 2.

sumed, for reasons that will presently appear, that the plunger will not be permitted to travel so far down as actually to come in contact with this opposing iron piece, but that its movement will be stopped at some point a little further to the right, such as that marked *E*. Then its range of motion will be from *E* to some point to the right. As in the figure, let its *range* of motion (or *stroke*, to use an engine term) be called *x*. Then it is clear that if any particular excitation by a given number of ampere-turns were provided, the pull would differ at different parts of the stroke, being a maximum when the plunger was at the end of its stroke, *E*, and being a minimum when the plunger was at the beginning of its stroke. For, when at the beginning of its stroke, the length of the internal gap is a maximum, and the flux-density will be a minimum, since from formula (2) we have: $B = IS/0.3133z$.

Now write P_{\max} for the pull at the end of the stroke, where *B* is a maximum, and P_{\min} for the minimum pull when *B* is at its minimum. The designer will generally be required to work between

a given maximum and a given minimum pull. Thus, for example, he may be required to design an apparatus to give a maximum pull of 100 lbs. and a minimum pull of 40 lbs., with a stroke of 2 ins. Let the ratio of the maximum pull to the minimum pull be called y . Then, since, by formula (1), P varies as the square of B , we have; $y = P_{\max.}/P_{\min.} = B^2_{\max.}/B^2_{\min.}$; whence, $\sqrt{y} = B_{\max.}/B_{\min.}$; and $B_{\min.} = B_{\max.} \div \sqrt{y}$. (3)

Going back to formula (2), and writing it out for the two extreme cases, we have, at the beginning of the stroke, where the distance along the gap from iron to iron is at its maximum value, which we will call z , $B_{\min.} \times z \times 0.3133 = IS$; and at the end of the stroke, when the gap is reduced to $z-x$, $B_{\max.} \times (z-x) \times 0.3133 = IS$. From this it follows that $z/(z-x) = B_{\max.}/B_{\min.} = \sqrt{y}$. Hence, z must necessarily have the value

$$z = \frac{\sqrt{y}}{\sqrt{y}-1} \times x \quad ; \quad (4)$$

and as y is the ratio of the specified maximum and minimum pulls, it is at once seen that, in order to calculate z from x this function of y becomes important. For convenience some values of it are here tabulated for reference. The ratio $\sqrt{y}/(\sqrt{y}-1)$ is called u for brevity.

TABLE I of Functions for Pull-Ratio y .

$y = P_{\max.}/P_{\min.} \dots$	1.0	1.5	2.0	2.5	3.0	3.5	4.0	5.0
$u = \sqrt{y}/(\sqrt{y}-1) \dots$	∞	5.4	3.44	2.7	2.37	2.15	2.0	1.88
$1/u = 1-1/\sqrt{y} \dots$..	0.185	0.29	0.37	0.42	0.465	0.5	0.55
$1/(\sqrt{y}-1) \dots \dots \dots$	∞	4.4	2.44	1.7	1.37	1.15	1.0	0.88

$y = P_{\max.}/P_{\min.} \dots$	6.0	7.0	8.0	9.0	10.0	16.0	25.0	100.0
$u = \sqrt{y}/(\sqrt{y}-1) \dots$	1.69	1.60	1.55	1.5	1.47	1.33	1.2	1.11
$1/u = 1-1/\sqrt{y} \dots$	0.59	0.625	0.645	0.666	0.68	0.75	0.8	0.9
$1/(\sqrt{y}-1) \dots \dots \dots$	0.69	0.6	0.55	0.5	0.47	0.33	0.2	0.11

So far as the first two lines of the table are concerned, their use is exemplified as follows: Taking the instance of a design to have a pull varying from 40 lbs. to 100 lbs. with a stroke of 2 ins., we have here $y = 100 \div 40 = 2.5$, and looking in the table we see the corresponding value of u is 2.7. This means that we must multiply the stroke by 2.7 to find z , which will, therefore, be 5.4. In fact, unless we design the apparatus so that at the beginning of the stroke

the reluctance of the magnetic circuit is 2.7 times as great as the reluctance is at the end of the stroke, we shall find that the minimum pull will drop to a less value than $\frac{1}{2.5}$ of the maximum pull. It is obvious that, if the minimum pull is specified to come to a higher fraction of the maximum, the greater will be u .

Next, returning to formula (1), let us remember that if d be the diameter of the core, the area A of its end face will equal $d^2 \times 0.7854$. Hence we may immediately deduce the new rule that:—

$$d = 9,580 \times \sqrt{P_{\min.}} / B_{\min.} \quad (5)$$

This determines the diameter of the core if $B_{\min.}$ has been fixed. Conversely, if d is given we can fix $B_{\min.}$ as follows:—

$$B_{\min.} = 9,580 \times \sqrt{P_{\min.}} / d. \quad (5a)$$

To get a new relation we may go back to formula (2), and inserting in it the value of $B_{\min.}$ just obtained, and z is the total gap length, we find:—

$$3,000 \times z \times \sqrt{P_{\min.}} / d = IS \quad (6)$$

This enables us to calculate the required number of ampere-turns if the diameter of the core has been fixed. The rule is in itself of some practical interest, for it shows us that in any given case where the maximum and minimum pulls, and the stroke, are given, the necessary ampere-turns will vary inversely as the diameter chosen for the core. If we double, for example, the diameter of the core, making the plunger four times as heavy as before, the excitation may be reduced to one-half.

We are now ready to consider a number of trial values or alternative designs to fulfil any prescribed case. Using the same illustration as before, we will put down as being specified $P_{\max.} = 100$ lbs.; $P_{\min.} = 40$ lbs.; $x = 2$ ins. We have already found $y = 2.5$, $u = 2.7$ and $z = 5.4$. We also know that $\sqrt{y} = 1.58$. Hence, by rule (3), $B_{\min.} = B_{\max.} \div 1.58$. Also $\sqrt{P_{\min.}} = 6.32$.

Schedule of Trial Values.

$B_{\max.}$	100,000	80,000	60,000	50,000	40,000	30,000	20,000
$B_{\min.}$	63,290	50,640	37,980	31,645	25,320	18,990	12,660
d	0.96	1.2	1.6	1.91	2.39	3.19	4.78
IS	107,000	85,600	63,600	53,500	42,800	31,800	21,400

We first put down some trial values of $B_{\max.}$ and, dividing each by \sqrt{y} , we get corresponding values of $B_{\min.}$ By formula (5) we

then find the resulting values of d ; and then IS follows either from (6) or from the rule

$$IS = B_{\min.} \times z \times 0.3133 \quad (2b)$$

On comparing together the values so set down, we see at once that if we attempt to work up to a maximum density of magnetic field in the gap as high as 100,000 lines per square inch, the plunger may have a diameter of only 0.96 ins.; but then we should have to provide no fewer than 107,000 ampere-turns of excitation. And when we consider that on large multipolar dynamos the amount of excitation on one pole is generally of the order of 6000 to 10,000 ampere-turns, or exceptionally rises to 20,000 in large alternators, we see that this design is impossible by reason of the copper required. On the other hand, if we reduce the maximum density to 20,000, the core diameter comes up to 4.78 ins., and the ampere-turns fall to 21,400.

The considerations which will settle our choice between the various alternatives have yet to be laid down. It may be remarked that a different order of procedure might have been followed. Thus we might have taken as trial values for d , 1, $1\frac{1}{2}$, 2, 3, 4 ins., and calculated the corresponding values of $B_{\min.}$ and thence $B_{\max.}$ from formula (5a).

It is found in practice that the maximum pulls are given with great accuracy by the above rules, but that, owing to secondary causes, the minimum pulls are rather higher (in some cases several per cent) than the calculated values.

We next enter on the thorny question of the length and depth of the magnetizing bobbin. Let us call the winding length between the bobbin cheeks L , and the available winding depth T . Also call the mean length of one turn M , then the sectional area of the whole winding is LT , and the winding volume is MLT . Also, if the actual permissible current density through the cross-section (not the current density in the copper only) in amperes per square inch be called β , we obviously have the relation $LT \times \beta = IS$. So, if β is known from experience we get the rule

$$LT = IS/\beta \quad (7)$$

Now experience shows that if proper pains are taken to give cooling surface, by radiating ribs or otherwise, β may be as great as 2000 or 3000 for coils that are used for momentary work — that is to say, for which the current is never kept on for more than 20 or 30 seconds at a time. For apparatus in which the current is kept on

for as much as 10 minutes or more, much lower current-densities must be used. The extreme case of prolonged use for several hours continuously involves either special cooling arrangements with internal ducts, or else the use of a very low density, such as $\beta = 300$ to 400. This is at best a rough way of reckoning; the more exact way is indicated later. If in cases for momentary use we assume $\beta = 2000$, we can fix a provisional value for the winding area LT . Now we have seen that the requirement that the minimum pull shall not fall below a definite fraction of the maximum pull involves the provision of a total length, z , of "equivalent gap" which is u times greater than the actual stroke. The greater u is the greater must the excitation be for a given maximum pull. Thus, for example, to give a maximum pull of 12 lbs., using a core 1 in. in diameter, and with a stroke of 3 ins., will require an excitation of 133,000 ampere-turns if the minimum pull is not to drop below 8 lbs.; whereas it will only require 46,600 ampere-turns if the minimum is permitted to drop to 4 lbs., and only 4080 if the minimum is permitted to drop to 1 lb. at the beginning of the stroke. We have to pay a very heavy price in ampere-turns (that is, in copper, or in current, or both) for the attempt to keep up the minimum pull.

Suppose that the total winding area LT has been provisionally found, it remains to ascertain the separate values of L and T . This is again a matter where experience must to some extent guide. The total weight of copper (for a given number of ampere-turns) will be reduced if we make L very long and the depth T small, since then the mean length per turn is kept small. But L should obviously have *some* relation to the length of stroke, since it would be absurd to use a very long bobbin if only a short stroke is required, and a long stroke cannot be got if the bobbin is short. Here it must be remembered that in order to keep up the minimum pull at the beginning of the stroke we were forced to provide an addition to the gap, or, rather, to calculate the ampere-turns as if the gap-length were z not x . A glance at Fig. 2 will make it clear that if for this reason the gap has had to be increased from x to z , the length L of the exciting bobbin cannot be less than z . For, if there is a good stuffing-box or cylindrical collar at the right, we may reckon the beginning of the stroke as the point when the plunger actually begins to enter the windings, and at the other end there is no need to make the projecting iron piece enter further than the thickness

of the bobbin cheek. Hence, unless in some special case this would lead to an undue heaping up of the coils, it is a useful guide to take for L provisionally the same value as was found for z . All this is under the assumption still that the solenoid is going to be jacketed with iron, so that the only sensible reluctance in the magnetic circuit is that of the internal gap. If now we take equation (7) and insert in it the value of IS given in equation (6) we get

$$T = \frac{3000}{\beta} \times \frac{\sqrt{P_{\min.}}}{d} \times \frac{z}{L} \tag{8}$$

And if we assume as above that β may be as great as 2000 (for cases of apparatus used only for a few seconds at a time), and that $L = z$, the rule becomes

$$T = 1.5 \times \sqrt{P_{\min.}} / d \dots \dots \dots \tag{9}$$

Let us see how this works out in the example previously used. The minimum pull was 40 lbs., so $\sqrt{P_{\min.}} = 6.32$ and z was 5.4 ins. If we had used a plunger 2 ins. in diameter, the exciting bobbin would have the following dimensions:— $L =$ at least 5.4 ins., $T =$ at least 4.74 ins. This, allowing $\frac{1}{4}$ in. for the tubular part of the bobbin, would imply an exciting coil the inner diameter of which was 2.25 and the outer diameter 11.73 ins. If, instead, a plunger 4 ins. in diameter had been used, formula (9) shows that T would be reduced to 2.37 ins., and the inner and outer diameters of the coil would become 4.25 ins. and 8.99 ins. respectively.

Another approximate way of estimating the length L of the exciting bobbin is to draw upon experience, which shows that if T is not more than, say, 3 ins., and due care is taken as to cooling, each inch length of tubular coil can carry from 3000 to 10,000 ampere-turns, the lower number being appropriate for cases of continuous service, the higher for cases of momentary service only. Now, this gives us a means of judging which of the trial values previously set out should be selected, for, since on $B_{\min.}$ depends the number of ampere-turns needed, it must not be taken too high. If we apply these considerations to formula (2) we find at once that, in apparatus for prolonged work, $B_{\min.}$ must not exceed 9580; while in that for momentary use $B_{\min.}$ may be taken at 16,000 or 20,000, or even up to 38,000 in those cases where there is no danger of $B_{\max.}$ rising over 100,000. To find the mean length of one turn M , on the supposition that the thickness of the tubular walls of the bobbin and the internal clearance add 0.25 ins. to the diameter, the formula is

$$M = \pi(0.25 + d + T). \tag{10}$$

So far we have considered the excitation simply as so many ampere-turns, regardless of the separate values to be assigned to the amperes and the turns, and regardless of the resistance of the coil or of the watts wasted in it as heat. Now, as the rules pertaining to these matters are in no way different from those of ordinary electromagnets they may be here treated as briefly as possible by merely quoting those that will be found most useful. The symbols used are as follows:—

- α = ampere-density in the copper section.
 β = ampere-density in the gross winding space.
 d = diameter (bare) of wire in inches.
 d_1 = diameter (covered) of wire in inches.
 R = resistance of coil in ohms.
 r_1 = resistance of wire per inch in ohms.
 ρ_1 = resistance per cubic inch of coil space.
 s = sectional area of wire in square inches.
 σ = space-factor = copper area \div gross area.
 V = voltage applied to terminals of coil.
 w = watts consumed = $IV = I^2R$.

If I is prescribed, $IS \div I = S$; $\beta = IS \div LT$; $\rho_1 = \alpha\beta \times 0.8/I^2 \times 10^6$, which fixes the gauge of the wire; $s = I \div \alpha$; $V = w \div I$

If V is prescribed, $I = w \div V$; $r_1 = V/M \times IS$, which fixes the gauge of the wire, or $12,000V/M \times IS =$ resistance per 1000 ft.;

$$d = \frac{1}{1,000} \sqrt{\frac{M \times IS}{V}};$$

$$s = \frac{IS \times M}{V} \times \frac{0.8}{10^6}.$$

The following are also useful: $\sigma = 0.785 \times d^2 \div d_1^2$; $LT = S \times s \div \sigma$;
 $M = 420 \times d \times w/a \times z \times \sqrt{P_{\min}}$.

Example.— An example will make the process clearer. The case taken is an iron-clad coil to give a pull of 10 lbs., increasing to 30 lbs., over a range of 1 in. Voltage of supply 100 volts for intermittent work. Here $P_{\max} = 30$; $P_{\min} = 10$; $x = 1$; $y = 3$; $\sqrt{y} = 1.732$; u (see Table I) = 2.37; $z = 2.37$; $\sqrt{P_{\min}} = 3.16$.

$$IS \times d = 3,000 \times 2.37 \times 3.16 = 22,500, \text{ by formula (6).}$$

$$B_{\min} \times d = 9580 \times 3.16 = 30,300, \text{ by formula (5).}$$

$$B_{\max} = B_{\min} \times \sqrt{y}, \text{ by formula (3).}$$

Trial Values.

<i>d</i>	0.5	1.0	1.5	2.0
<i>IS</i>	45,000	22,500	15,000	11,250
<i>B_{min.}</i>	60,600	30,300	20,200	15,150
<i>B_{max.}</i>	104,800	52,400	34,930	26,200

The first of these requires too many ampere-turns for so small an apparatus. To judge of the merits of the designs we calculate them out, assuming that β may be taken as high as 2000, so that $LT = IS \div 2000$. If the space-factor is taken at 0.5, this implies that the current density in the copper will be $a = 4000$ amperes per square inch.

Trial Values.

<i>LT</i>	22.5	11.25	7.5	5.625
<i>L</i>	7.5	3.75	3.0	2.82
<i>T</i>	3.0	3.0	2.5	2.0
<i>M</i>	11.8	13.4	13.4	13.4
<i>LTM</i>	266.0	151.0	101.0	75.5
<i>δ</i>	0.0730	0.0550	0.0450	0.0389
<i>s</i>	0.00434	0.00242	0.00161	0.00121
<i>I</i>	17.36	8.68	6.44	4.84
<i>S</i>	2,600.0	2,325.0	2,325.0	2,327.0
<i>w</i>	1,736.0	868.0	644.0	484.0
Lbs. of copper	42.3	24.0	16.0	12.0
Wt. of plunger	0.6	1.53	3.05	5.2

The last of these designs is the cheapest, and wastes less power than the others; but if the weight of the iron jacket is included it will be rather heavier than the third design.

In calculating the length L in the above example, it was assumed that T must, for reasons of heating, not exceed 3 ins., and this assumption caused L to be greater than z , as it must in many cases be. For if the whole coil is taken as short as z , then the coils may pile up to too great a thickness, and with the increase in the mean length of one turn will come a great weight of copper, and, what is also bad, the cooling surface will be insufficient. The relation between watts expended and necessary cooling surface cannot be stated with any precision, because of the intermittent nature of the user of the apparatus. But, taking the watt-consumption during the periods of use, and averaging it out over an hour, if the average consumption came to more than 3 watts per square inch of cooling

surface the design ought to be reconsidered to give more cooling surface. Even so, the temperature rise will exceed that permitted in dynamos and motors. Lengthening the coil always is advantageous from this point of view, for it not only increases the surface but reduces the mean length of the turn and, for a given permissible watt-consumption, reduces the weight of copper; or for a given weight of copper it reduces the watt-consumption.

Incompletely Enclosed Coils — So far we have assumed an iron-clad type of coil, and we have found that, in order to fulfil the specified conditions of the minimum pull at the beginning of the stroke not falling below a certain fraction of the final pull, it was necessary to make z , the length of the equivalent gap at the beginning of the stroke, longer than the length x of the stroke itself. In other words, there was left in Fig. 2 a space between the bottom of the plunger, when it reached the end of its stroke at E , and the end of the iron piece which closed the tube. In engineers' language, a clearance was left at the end of the cylinder below the piston. This clearance space might be filled up with brass or any other non-magnetic material so far as the reasoning was concerned. It might be thought that this space simply wasted power by requiring more ampere-turns to drive the magnetism through it. But the part it plays is best seen by considering what would occur if it were not there. Suppose it to be filled up with iron. Then when the plunger is right up to E there would clearly be required very few ampere-turns to give the maximum pull. If the excitation were reduced accordingly, then, when the plunger was again pulled out to the top of its stroke, there would be so little excitation that the pull would fall far below the required minimum. So, then, it is absolutely necessary that when the plunger is at the bottom of its stroke, and the pull is a maximum, there should be this additional gap or its equivalent. Now that equivalent may be attained in another way — viz., if an equal amount of reluctance is introduced into the circuit at some other part. Let the point E , the bottom of the stroke, be shifted right to the end of the coil (on the left). Then a gap in the magnetic circuit can be obtained by removing the iron face-plate at the end, or as much of it as may be needed to produce an equivalent reluctance. Suppose we were dealing with the case where P_{\max} is four times P_{\min} , or where the pull-ratio $y = 4$. Reference to Table I shows that in this case $u = 2$ or $z = 2x$. If we removed the end shield this would possibly not sufficiently increase the reluctance — it might be necessary to cut off some of the external

jacket also. The amount would depend on the shape of the whole coil. If the whole cylindrical space down the tube were long compared with its diameter, the reluctance from end to end through the interior would be great compared with the reluctance of all the possible paths through the external air if the jacket had been entirely removed. Hence removing the jacket in such a case would not double, but would only slightly increase, the total reluctance existing when the plunger is in the position of beginning the stroke.

The principle of magnetic images will help toward an understanding of the matters involved. In a paper read by the author before the Electrical Congress at Como in 1900, it was shown, and experimental proofs were adduced confirming the theory, that if a sheet of iron of indefinitely great permeability compared with air, and of indefinitely large size, were placed beyond the end of a solenoid, the effect of its presence is precisely that of a *magnetic mirror*. At all points of the space in front of it the effect of its presence is the same as would be produced by the presence of a second solenoid of equal power situated behind the mirror at the place where, optically speaking, the virtual image of the first solenoid would be situated. If placed hard up against the end of the solenoid the effect is to double the length of the solenoid. If two such "mirrors" are placed against the two ends of a solenoid of finite length, they have the same effect as making the solenoid of infinite length.

Now it is known that the strength of the field (in c.g.s. units) at any point inside an indefinitely long uniform solenoid is given by the expression $H = 4\pi IS/10l$, l being in centimeters. The corresponding expression in inch units is $H_1 = IS/l \times 0.3133$. These values are true to within 1 per cent for the field at the mid-length of a solenoid, provided its length be not less than six times its internal diameter. The value of the field at the mouth of the solenoid is exactly half this value, as is at once seen by considering that the effect at the middle must be equally due to that part of the solenoid which lies to the right and to that which lies to the left. The effect of putting an iron sheet or end-plate across the end of an unjacketed solenoid is then (assuming the iron to be of indefinitely great permeability and extent) to bring up the value of the field within the mouth to the same amount as it would have if the solenoid were indefinitely extended and had the same number of ampere-turns per unit of length.

Consider by the light of this fact what is the effect of putting on

an iron face-plate with a well-fitting iron stuffing-box on the anterior end of the solenoid. Saving that it will have a permeability and an extent less than infinite, the effect of its presence is that, when the plunger is in the initial position just beginning to enter the coil, the field at that end of the tube is brought up to the same strength that it has at the middle. Now, even without such an end-plate, the extended long plunger performs partially the same function. If it were a perfect performer it would be pulled in this position with an initial pull corresponding to the magnetic tension along that field, and this, even with a long solenoid and as many as 2000 ampere turns per inch, would scarcely be as much as $\frac{1}{4}$ lb. per square inch of end surface of the plunger. Once entered, however, into the mouth of the coil the plunger experiences a pull which steadily increases — supposing the plunger to be at least a little longer than the coil — until its advancing end reaches the bottom of the coil, where the pull is a maximum. And this maximum is seen, by reasoning analogous to that used above, to be equal to one-quarter of the pull there would be between this plunger and its image if an iron mirror were placed against the bottom of the coil. What that pull would be will depend on the permeability of the iron as well as on the ampere-turns per unit of length that magnetize it and on its area of section. If the permeability is known, or its curve has been ascertained, B can be found from the curve; and the pull will be one-quarter of that calculated by equation (1). Hence it is the permeability of the iron as well as its section which determines the maximum pull of an unjacketed coil upon the plunger. In the ironclad coil it is the permeability of air in the gap (or in the equivalent gap) which determines the maximum pull; since, as experience shows, and as can be foreseen from the equations, those designs in which the plunger is of so small a diameter that saturation approaches a point where the reluctance of the iron need be taken into account, are more costly than those where the iron saturation is kept low.

Adaptation of the calculations to cases of coned plungers is reserved for a future publication, the present communication being confined to cylindrical plungers.

CHAIRMAN D. B. RUSHMORE: Professor Steinmetz is called to another Section this morning and has asked me to preside here in his absence. If there is no discussion on Professor Thompson's paper, I will call upon Prof. E. B. Rosa to read his paper on "The Influence of Wave Shape upon Alternating-current Meter Indications."

THE INFLUENCE OF WAVE FORM ON THE RATE OF INTEGRATING INDUCTION METERS.

BY E. B. ROSA, M. G. LLOYD AND C. E. REID.

We give in this paper the results obtained with five integrating induction wattmeters, on which we have made a considerable number of tests although further work remains to be done. The work was interrupted by transferring the machines and apparatus employed to St. Louis, where they were installed in the Exposition laboratory of the Bureau of Standards. It is our expectation to resume the work in a few months and to extend the experiments to a greater number of meters and to use a greater variation in the wave form. These results may therefore be regarded as preliminary, illustrating the methods employed and the results obtained when changes are made in the wave form by altering the magnitude or phase of the harmonics present.

Two of the meters employed were sent to the Bureau of Standards for test by the makers. The others were meters which we happened to have in the laboratory when the tests were undertaken. The following is a list of the meters:

- No. 1. Stanley (magnetic suspension type), 50 amperes.
- No. 2. Stanley (magnetic suspension type), 50 "
- No. 3. General Electric (1902 house type), 25 "
- No. 4. Fort Wayne (type "K"), - 50 "
- No. 5. Siemens & Halske, - - - 25 "

All are for 110 volts, 60 cycles, single-phase. The first four are American instruments, the last is of German make. Each meter was tested at full load and at normal voltage and approximately unity power factor.

In order to determine the effect on the rate of an induction meter due to varying the wave form, it is necessary to eliminate carefully any effects due to variation in the temperature of the meter, or changes in the frequency of current, or other alterations in the conditions of the meter or circuit. In most cases the effect of a moderate distortion of the wave is small, and unless all measurements are made with great care the effects looked for may be

masked by other effects or by errors of measurement. The meters were tested alternately with current of sine wave form and with a distorted wave, the distortion being produced by adding a harmonic of three times the frequency of the fundamental, varying both the amplitude and phase of this harmonic. This was done by means of an alternating-current generating set of three machines, two alternators and a direct-connected driving motor, one alternator having four poles and the other twelve. The current from each machine is very nearly of sine wave form, and tests were made of the meters alternately with the fundamental only and with the harmonic added.

Three different relative values and four different phases of the harmonic have been employed. The three values of the harmonic are 10, 25, and 50 per cent, respectively, of the value of the fundamental. For example, since $E = \sqrt{E_1^2 + E_3^2}$ in the first case the addition of 11 volts of the harmonic to 110 volts of the fundamental gives a resultant of about 110.5 volts, the wave being more or less peaked than a sine wave according to the phase of the harmonic. In the second case 108 volts of the fundamental plus 27 volts of the harmonic gives a resultant of 111.3 volts. (The voltage in each case was reduced to exactly 110 by resistance in series.) This resultant is shown in Figs. 1-4 where the 25 per cent harmonic is in different phase in each of the four cases. This difference is produced by shifting the coupling of one of the generators to the driving motor, 5 deg., 10 deg., or 15 deg. in the coupling, corresponding to 10 deg., 20 deg., or 30 deg. in the wave of the fundamental, or 30 deg., 60 deg., or 90 deg. in the phase of the harmonic. A shift of 30 deg. in the coupling corresponds to 180 deg. in the phase of the harmonic, and is the same as reversing the phase by reversing the connections at the terminals of the higher frequency generator. The latter is, of course, the more convenient, and was the usual method of changing from what we call a flat to a peaked wave. The curves shown in Figs. 1 to 4 have been frequently verified by drawing the resultant waves by means of a curve tracer. This not only verifies the wave form, but serves to insure against errors in the connections.

The current, voltage and power factor, as well as the temperature and frequency, were maintained as nearly constant as possible during a set of runs. A standard wattmeter which was calibrated by direct current, using two potentiometers to measure simultane-

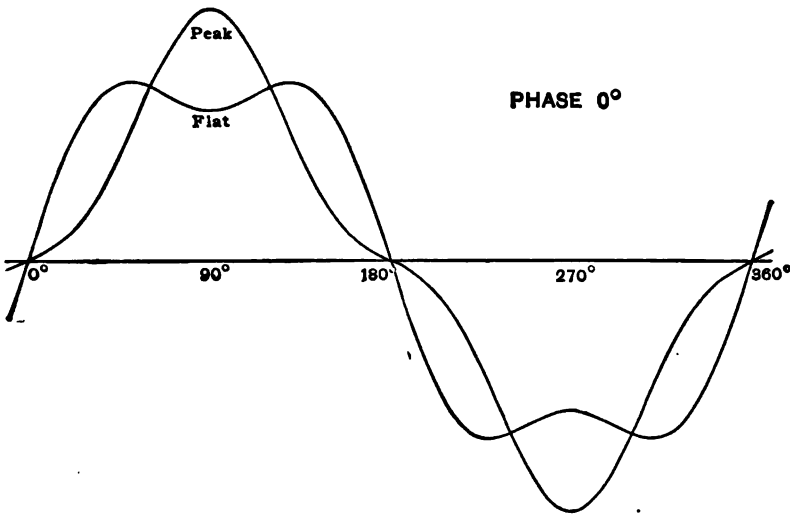

FIG. 1. Showing the resultant of combining with the fundamental a harmonic of three times the frequency, 25 per cent of the magnitude of the fundamental giving, first, a peaked wave and, second (when the phase of the harmonic is reversed), a flat or dimpled wave. Both fundamental and harmonic are of sine wave form.

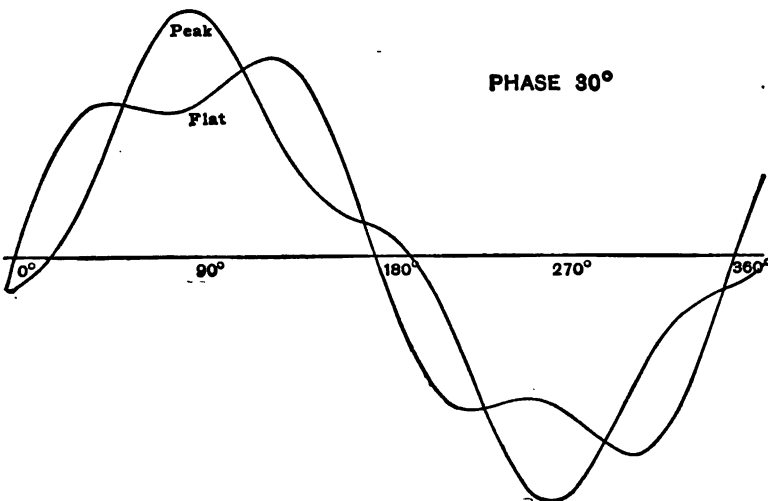

FIG. 2. Showing the resultant of a fundamental and a harmonic as in Fig. 1, except that the phase of the harmonic has been shifted 30 deg. by changing the coupling 5 deg.

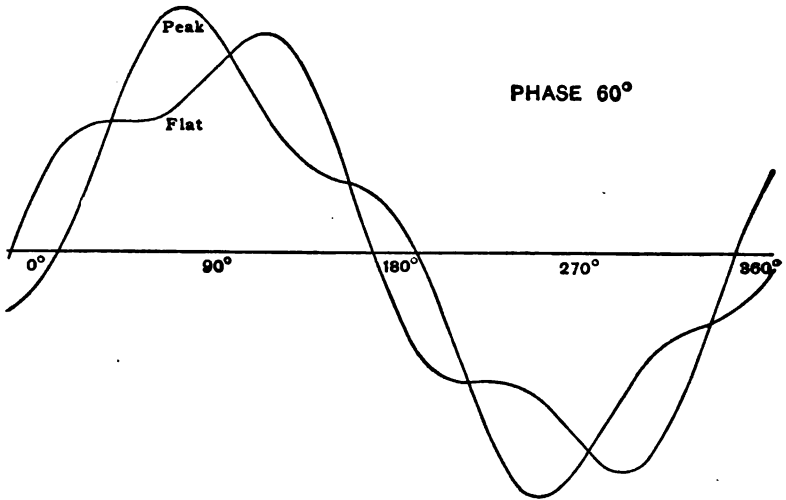

FIG. 3. Showing the resultant of a fundamental and a harmonic as in Fig. 1, except that the phase of the harmonic has been shifted 60 deg.

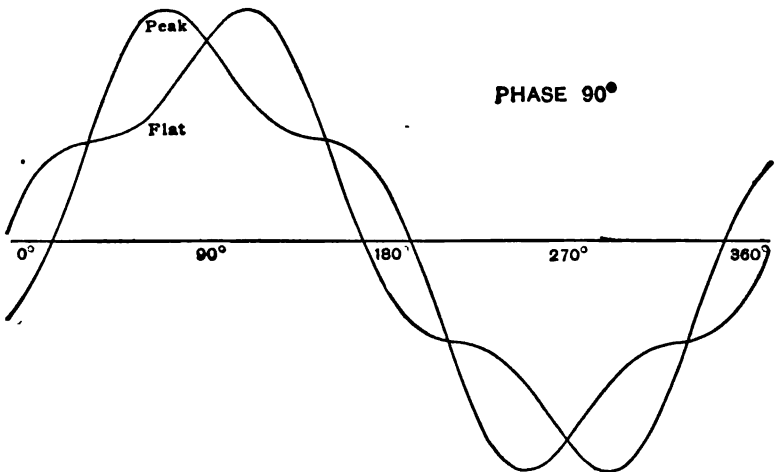

FIG. 4. Showing the resultant of a fundamental and a harmonic as in Fig. 1, except that the phase of the harmonic has been shifted 90 deg. by changing the coupling 15 deg. The wave form for "peak" and "flat" are here alike except that the steeper side is in advance in the "peak" and the less steep side is in advance in the "flat." "Peak" and "flat" are conventional terms, indicating the phase of the harmonic. If the coupling were shifted 15 deg. more the "flat" curve would become *peaked*.

ously the current and voltage, was read by a telescope and scale. By means of a carbon rheostat the deflection of this instrument was maintained accurately constant while carrying alternating current during a set of runs on the meters. The wattmeter is of the dynamometer type and astatic. The fixed coils are stranded and wound on wooden spools and very little metal is used in the region of the coils. The movable coils have very slight inductance and every precaution is taken to avoid errors due to eddy currents or wave form. The instrument being carefully calibrated with direct current is then correct for alternating current.

TABLE I.—DETERMINATION OF THE TIMES OF REVOLUTION OF THE DISKS OF THREE METERS. RUN NO. 1, MAY 28, 1904.

Number of contact.	METER No. 1.			METER No. 2.			METER No. 3.		
	Time of contact.	Interval between successive contacts.	Interval between 1st and 10th, etc. 100 revolutions.	Time of contact.	Interval between successive contacts.	Interval between 1st and 10th, etc. 100 revolutions.	Time of contact.	Interval between successive contacts.	Interval between 1st and 10th, etc. 120 revolutions.
1	1 5.30	1.55		0 45.96	1.60		0 45.70		
2	6.85	1.55		47.54	1.63		47.00	1.80	
3	8.40	1.65		49.24	1.57		48.31	1.81	
4	10.05	1.61		50.81	1.61		49.63	1.82	
5	11.66	1.64		52.42	1.63		49.63	1.87	
6	13.30	1.52		54.05	1.54		51.00	1.90	
7	14.82	1.63		55.59	1.68		52.30	1.80	
8	16.45	1.60		57.25	1.65		53.60	1.87	
9	18.05	1.67		58.90	1.60		54.97	1.88	
10	19.72	1.58		1 0.50	1.55		56.30	1.80	
11	21.30	48.60		2.05	48.25		57.60	1.40	
12	2 9.90	32.20		3 50.80	32.10		59.00	28.60	
13	42.10	32.22		2 22.40	32.10		1 25.60	39.88	
14	3 14.22	32.33		3 54.50	32.20		2 5.48	39.87	
15	45.65	161.35		3 26.70	32.20	100.74	3 45.85	39.95	159.60
16	48.20	161.35		23.85	1.65	100.79	3 25.30	1.90	159.60
17	49.82	1.63		29.95	1.60	100.71	28.60	1.80	159.59
18	51.41	1.59		31.54	1.59	100.73	27.90	1.80	159.57
19	53.00	1.59		33.10	1.58	100.73	29.20	1.85	159.57
20	54.61	1.61		34.73	1.68	100.73	30.55	1.40	159.55
21	56.22	1.61		36.38	1.60	100.73	31.95	1.35	159.55
22	57.90	1.68		38.00	1.63	100.79	33.30	1.33	159.70
23	59.48	1.58		39.60	1.60	100.75	34.63	1.33	159.66
24	1 08	1.55		41.19	1.59	100.70	35.95	1.40	159.65
25	2.62	1.59		42.80	1.61	100.69	37.35	1.40	159.75
						100.75	38.68	1.33	159.68
Mean.....		161.367				100.733			159.636
Time of one turn.....		1.6137				1.6073			1.3303

DETERMINATION OF THE RATE OF THE METERS AND THE FREQUENCY OF THE CURRENT.

The rate of the meters was determined by means of a chronograph and chronometer, record being made at the end of every revolution of the disc or drum for the first ten revolutions at the

beginning of a run and the last ten at the end of the run, and, in addition, once in ten or twenty revolutions during the run. The runs average about three minutes each. The record on the chronograph sheet was read by means of a diagonal scale, and gave the mean time of one revolution with great accuracy. An example is given in Table I. Eleven independent determinations of the time of 100 revolutions of the disc are given in the third and sixth columns for meters 1 and 2, and of 120 revolutions in the ninth column for meter 3. The average of these 11 values is used in deriving the mean time for one revolution. At the same time an electric circuit was closed by a contact point connected to the generator once in every hundred revolutions, and these contacts were recorded on the chronograph sheet. This gave the frequency of the current very exactly. A slight correction is

TABLE II.—RECORD FOR DETERMINING THE FREQUENCY OF THE CURRENT.

Time of contacts at beginning of run.		Time of contacts at end of run.		Interval for 5100 revolutions.
<i>Mtn.</i>	<i>Sec.</i>	<i>Mtn.</i>	<i>Sec.</i>	<i>Sec.</i>
1	3.25	3	53.40	170.15
	6.60		56.73	170.18
	9.93	4	0.05	170.18
	13.28		3.40	170.12
	16.60		6.75	170.15
$\text{Frequency} = \frac{2 \times 5100}{170.136} = 59.95$				Mean 170.136

applied to the rate of each meter for the small departure of the frequency from 60, which is the standard frequency for the meters tested. This correction is of course determined for each meter separately. In Table II the readings from the chronograph record are given for determining the frequency of the current, which in this case averaged 59.95 for the period of the run.

Before making a series of runs on the meters the load was applied and they were warmed up to an equilibrium temperature. In order to eliminate errors due to any changes in temperature that might subsequently occur, as well as any other constant errors due to changing conditions, and so obtain the effect of the varying wave form alone, the tests with distorted wave forms were interspersed with tests using sine-wave forms. Any progressive change in the meters or the standard wattmeter would thus be eliminated.

TABLE III.—TIMES FOR ONE REVOLUTION OF DISK.

No. of run.	Phase of harmonic.	Lag of current.	Form of wave.	Frequency.	Meter No. 1.	Mean.	Meter No. 2.	Mean.	Meter No. 3.	Mean.
	Deg.	Deg.			Sec.		Sec.		Sec.	
1.....		19.9	Sine	59.96	1.6127		1.6073		1.8908	
4.....		18.9	Sine	60.85	1.6178		1.6109		1.8921	
7.....		18.6	Sine	60.23	1.6148	1.6154	1.6071	1.6064	1.8900	1.8906
2.....	0	19.8	Peak	59.99	1.6180		1.6066		1.8438	
5.....	0	19.0	Peak	60.81	1.6187	1.6188	1.6105	1.6069	1.8425	1.8481
3.....	0	17.0	Flat	60.38	1.6203		1.6141		1.8407	
6.....	0	Flat	60.28	1.6184	1.6198	1.6121	1.6181	1.8390	1.8398
8.....	Sine	59.96	1.6121		1.6051		1.8329	
11.....	20.0	Sine	60.08	1.6169		1.6069		1.8320	
14.....	19.2	Sine	59.95	1.6153	1.6148	1.6068	1.6077	1.8307	1.8305
9.....	30	19.1	Peak	60.09	1.6197		1.6116		1.8440	
12.....	30	19.8	Peak	59.98	1.6202	1.6199	1.6125	1.6120	1.8448	1.8441
10.....	30	17.7	Flat	60.12	1.6149		1.6091		1.8405	
13.....	30	17.0	Flat	59.99	1.6155	1.6152	1.6068	1.6091	1.8404	1.8404
15.....	19.5	Sine	60.14	1.6148		1.6069		1.8390	
18.....	18.9	Sine	60.04	1.6158		1.6066		1.8393	
21.....	18.3	Sine	59.90	1.6162	1.6156	1.6068	1.6068	1.8311	1.8309
16.....	60	17.9	Peak	60.10	1.6214		1.6127		1.8428	
19.....	60	17.2	Peak	60.12	1.6219	1.6216	1.6140	1.6138	1.8429	1.8426
17.....	60	16.6	Flat	60.05	1.6127		1.6093		1.8398	
20.....	60	15.9	Flat	59.94	1.6125	1.6126	1.6059	1.6061	1.8390	1.8391
22.....	20.2	Sine	60.28	1.6151		1.6078		1.8392	
25.....	Sine	60.10	1.6152		1.6064		1.8307	
28.....	19.8	Sine	60.05	1.6150	1.6151	1.6077	1.6079	1.8306	1.8305
23.....	90	18.9	Peak	60.18	1.6211		1.6133		1.8417	
26.....	90	18.3	Peak	60.07	1.6222	1.6216	1.6138	1.6136	1.8422	1.8419
24.....	90	18.0	Flat	60.10	1.6124		1.6056		1.8401	
27.....	90	Flat	60.04	1.6127	1.6125	1.6052	1.6054	1.8399	1.8400
29.....	19.3	Sine	59.96	1.6162		1.6091		1.8322	
32.....	19.1	Sine	60.15	1.6183		1.6105		1.8325	
35.....	19.3	Sine	60.11	1.6190	1.6173	1.6113	1.6108	1.8333	1.8328
30.....	60	18.1	Peak	59.83	1.6234		1.6145		1.8447	
33.....	60	Peak	60.11	1.6244	1.6239	1.6154	1.6149	1.8450	1.8448
31.....	60	16.8	Flat	60.22	1.6143		1.6097		1.8405	
34.....	60	16.3	Flat	60.10	1.6155	1.6149	1.6091	1.6099	1.8423	1.8414
36.....	20.0	Sine	60.12	1.6184		1.6116		1.8399	
39.....	20.1	Sine	60.20	1.6177		1.6103		1.8390	
41.....	20.1	Sine	60.25	1.6176	1.6179	1.6104	1.6106	1.8325	1.8332
37.....	80	19.5	Peak	60.12	1.6223		1.6139		1.8457	
40.....	80	Peak	60.23	1.6219	1.6220	1.6131	1.6131	1.8454	1.8455
38.....	80	17.5	Flat	60.17	1.6169		1.6104		1.8414	
42.....	80	Flat	60.27	1.6196	1.6182	1.6115	1.6109	1.8417	1.8415
44.....	20.2	Sine	1.6178		1.6101		1.8328	
47.....	20.4	Sine	60.01	1.6176	1.6177	1.6112	1.6106	1.8323	1.8327
45.....	0	Peak	1.6191		1.6104		1.8453	
48.....	0	22.0	Peak	60.11	1.6190	1.6190	1.6107	1.6105	1.8460	1.8456
43.....	0	Flat	1.6216		1.6154		1.8424	
46.....	0	17.6	Flat	60.04	1.6224	1.6220	1.6154	1.6154	1.8423	1.8426

TABLE IV.—25 PER CENT HARMONIC. MEAN VALUES OF THE TIMES OF REVOLUTION OF THREE METERS IN 49 RUNS OF MAY 29, COMPILED FROM TABLE III.

PHASE OF HARMONIC.	Run numbers.	METER NO. 1.			METER NO. 2.			METER NO. 3.		
		Times of revolution.	Means and differences.	Differences in per cent.	Times of revolution.	Means and differences.	Differences in per cent.	Times of revolution.	Means and differences.	Differences in per cent.
0°	1-7 44-47	1.6154 1.6177	1.6166	Sine	1.6164 1.6168	1.6066	Sine	1.6206 1.6227	1.6219	Sine
0°	2-6 45-49	1.6133 1.6140	1.6187 +28	Peak +1.5%	1.6199 1.6165	1.6102 +7	Peak +0.4%	1.6461 1.6466	1.8444 +136	Peak +9.4%
0°	8-6 45-46	1.6133 1.6220	1.6207 +45	Flat +3.5%	1.6131 1.6154	1.6143 +45	Flat +3.0%	1.6293 1.6286	1.8413 +94	Flat +7.0%
30°	8-11-14 36-39-41	1.6145 1.6175	1.6164	Sine	1.6077 1.6103	1.6068	Sine	1.6205 1.6228	1.8319	Sine
30°	9-12 37-40	1.6130 1.6220	1.6210 +46	Peak +3.5%	1.6120 1.6151	1.6128 +58	Peak +2.1%	1.8441 1.8455	1.8443 +129	Peak +9.6%
30°	10-13 38-42	1.6133 1.6132	1.6167 +5	Flat +1.6%	1.6091 1.6109	1.6100 +7	Flat +0.5%	1.8404 1.8415	1.8410 +91	Flat +6.5%
60°	15-18-21 29-32-35	1.6155 1.6173	1.6167	Sine	1.6083 1.6103	1.6068	Sine	1.8302 1.8328	1.8319	Sine
60°	16-19 30-33	1.6216 1.6239	1.6223 +61	Peak +3.8%	1.6133 1.6149	1.6141 +46	Peak +2.2%	1.8428 1.8445	1.8427 +113	Peak +8.8%
60°	17-20 31-34	1.6123 1.6149	1.6133 -29	Flat -1.6%	1.6031 1.6039	1.6075 -21	Flat -1.1%	1.8391 1.8414	1.8403 +84	Flat +6.5%
90°	22-25-28	1.6151	1.6151	Sine	1.6079	1.6079	Sine	1.8305	1.8305	Sine
90°	23-26	1.6216	1.6216 +65	Peak +4.0%	1.6133	1.6133 +58	Peak +3.6%	1.8419	1.8419 +114	Peak +8.6%
90°	24-27	1.6125	1.6125 -36	Flat -1.6%	1.6054	1.6054 -25	Flat -1.5%	1.8400	1.8400 +95	Flat +7.1%

TABLE V.—EFFECT OF VARYING PHASE OF HARMONIC. CHANGE OF RATE OF METER IN PER CENT.

10 % HARMONIC.	PHASE 0°.				PHASE 30°.				PHASE 60°.				PHASE 90°.				
	FLAT.		PEAK.		FLAT.		PEAK.		FLAT.		PEAK.		FLAT.		PEAK.		
	Fast.	Slow.	Fast.	Slow.	Fast.	Slow.	Fast.	Slow.	Fast.	Slow.	Fast.	Slow.	Fast.	Slow.	Fast.	Slow.	
Meter No. 1.....	0.07	0.11	0.13
Meter No. 2.....	0.06	0.07	0.11
Meter No. 3.....	0.05	0.07	0.06
Meter No. 4.....	0.01	0.08
Meter No. 5.....	0.05
25 % HARMONIC.																	
Meter No. 1.....	0.26	0.14	0.40
Meter No. 2.....	0.30	0.04	0.02	0.18	0.36
Meter No. 3.....	0.70	0.94	0.04	0.13	0.86
Meter No. 4.....	0.27	0.26	0.85	0.83	0.86
Meter No. 5.....	0.62	0.36	0.41	0.64	0.61
50 % HARMONIC.																	
Meter No. 1.....	0.77	0.41	0.74
Meter No. 2.....	0.81	0.26	0.55
Meter No. 3.....	2.84	8.21	8.08
Meter No. 4.....	0.39	1.01
Meter No. 5.....	3.10	3.26

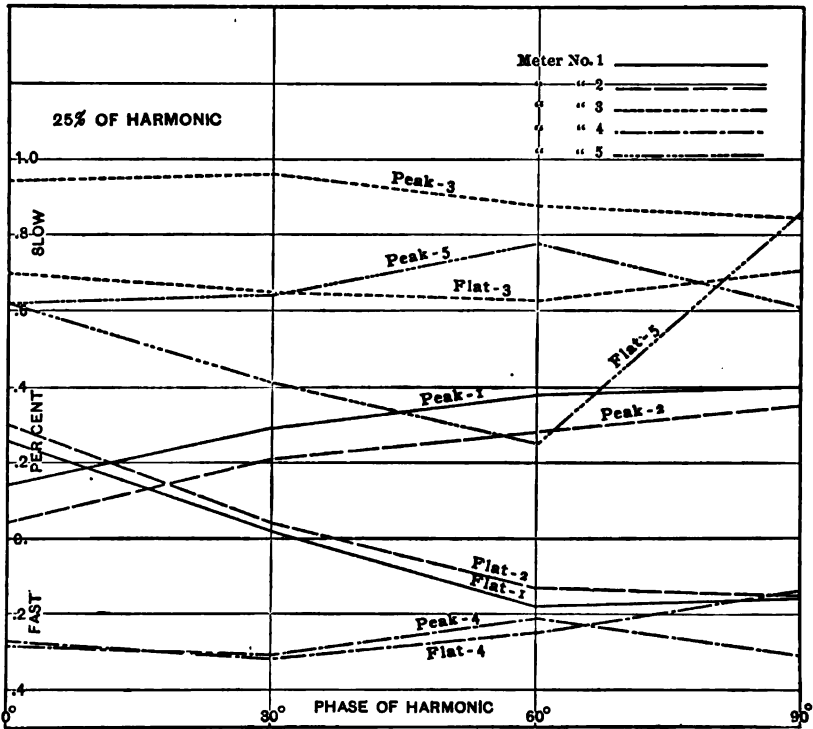

FIG. 5. Showing the variation in the rate of five induction meters with 25 per cent harmonic in the current as the phase of the harmonic is changed from 0 deg. to 30 deg., 60 deg. and 90 deg.

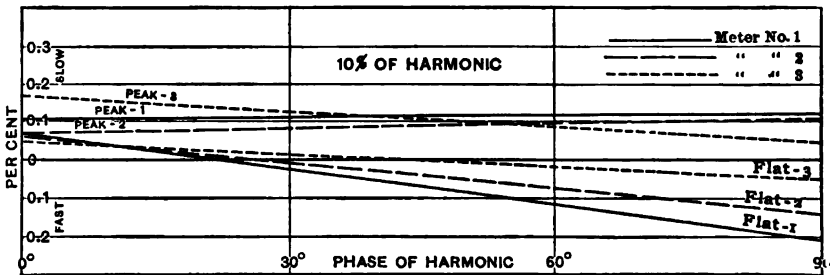

FIG. 6. Showing the variation in the rate of three induction meters with 10 per cent harmonic in the current as the phase of the harmonic is changed from 0 deg. to 90 deg.

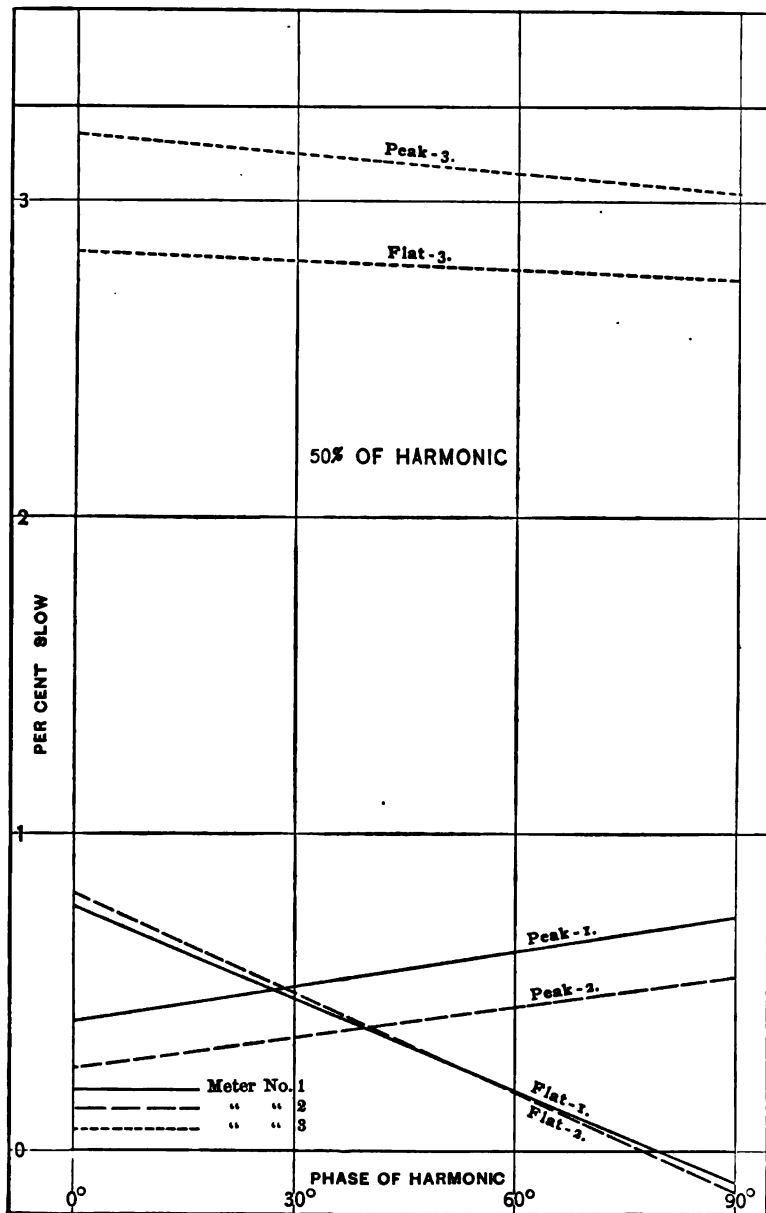

FIG. 7. Showing the variation in the rate of three induction meters with 50 per cent harmonic in the current as the phase of the harmonic is changed from 0 deg. to 90 deg.

Table III gives the results of 49 runs on three meters made May 26th, using a sine wave and a distorted wave due to 25 per cent harmonic, peak and flat, as shown in Figs. 1 to 4. The numbers of the runs show the order in which they were taken. For example, the 1st, 4th and 7th were made with a sine wave, and are grouped together in the table. The actual frequency for each run is given in the table, but the time of one revolution given in

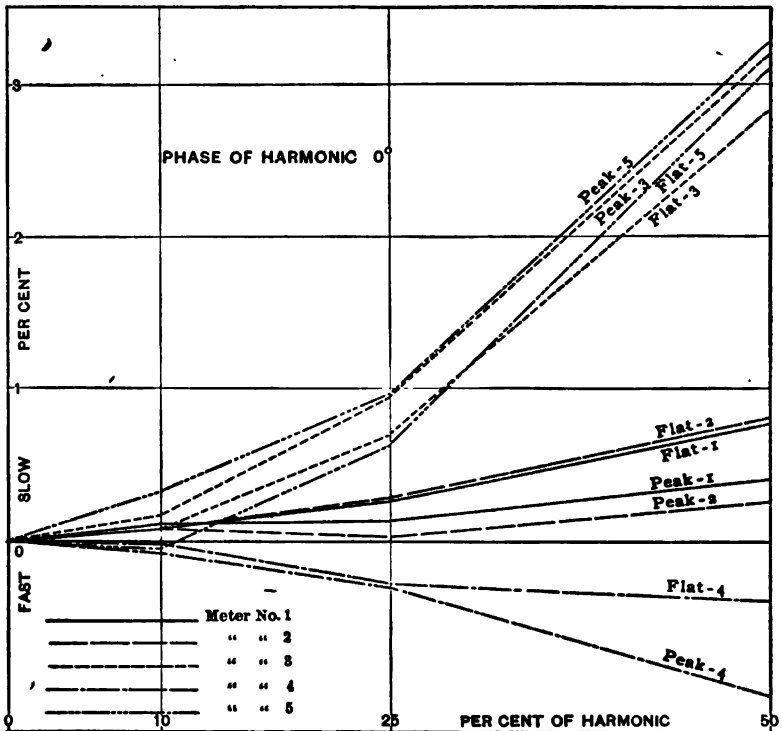

FIG. 8. Showing the variation in the rate of five induction meters with 10, 25 and 50 per cent of harmonic, the phase of the harmonic in each case being 0 deg.

columns 5, 7 and 9 have been reduced to 60 cycles. The numbers given in columns 6, 8 and 10 are the means of the corresponding values in columns 5, 7 and 9.

Runs two and five were made using a peaked wave and runs three and six using a flat wave. The phase of the harmonic was then shifted 30 deg. and seven runs made in the same order as

before. The third set of seven runs was made with the harmonic at 60 deg., the fourth set at 90 deg., and then three more sets of runs were made in reverse order with respect to the phase of the harmonic, making in all seven sets of seven runs each. The difference in per cent obtained in Table IV, together with corresponding differences in other runs using 10 and 50 per cent harmonic, the detailed results of which are not here given, are shown in

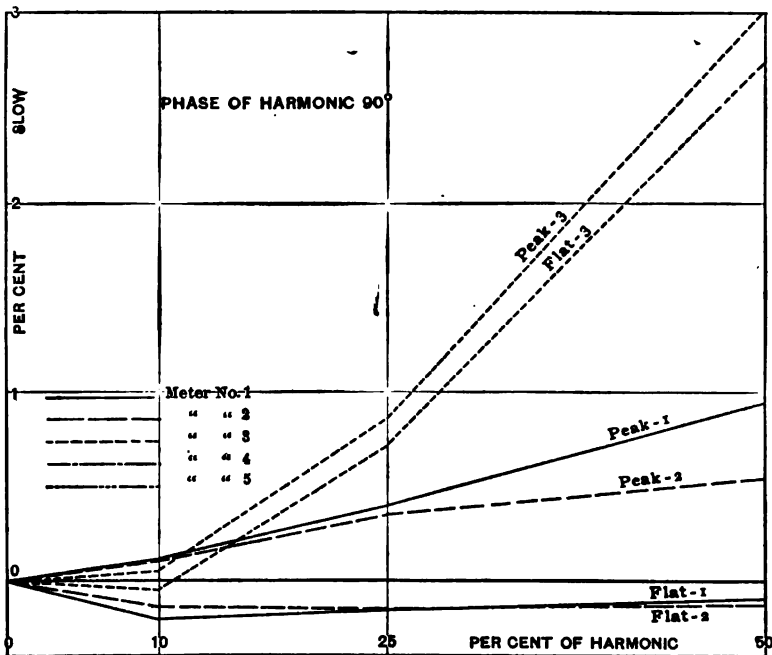

FIG. 9. Showing the variation in the rate of three induction meters with 10, 25 and 50 per cent of harmonic, the phase of the harmonic in each case being 90 deg.

Table V. The second decimal figure in the differences of this table is of course uncertain. All these results are plotted in Figs. 5 to 9. The results obtained in the runs of May 26th, given in Tables III and IV, are plotted in Fig. 5.

The maximum variation due to 25 per cent harmonic is, in the case of meter No. 4, a little less than 1 per cent; being greater with the peak than the flat, but not varying much with the phase of the harmonic. On the other hand, meters 1 and 2 show

smaller errors due to the presence of the harmonic, but greater changes due to shifting the phase of the harmonic, both changing from slow to fast on the flat wave when the phase is shifted. Meter No. 4 runs faster for both peak and flat, and at all phases, than on a sine wave; it is the only meter of the five for which this is true.

Fig. 6 shows the effect of changing the phase of the harmonic from 0 deg. to 90 deg. when using a harmonic of 10 per cent, and

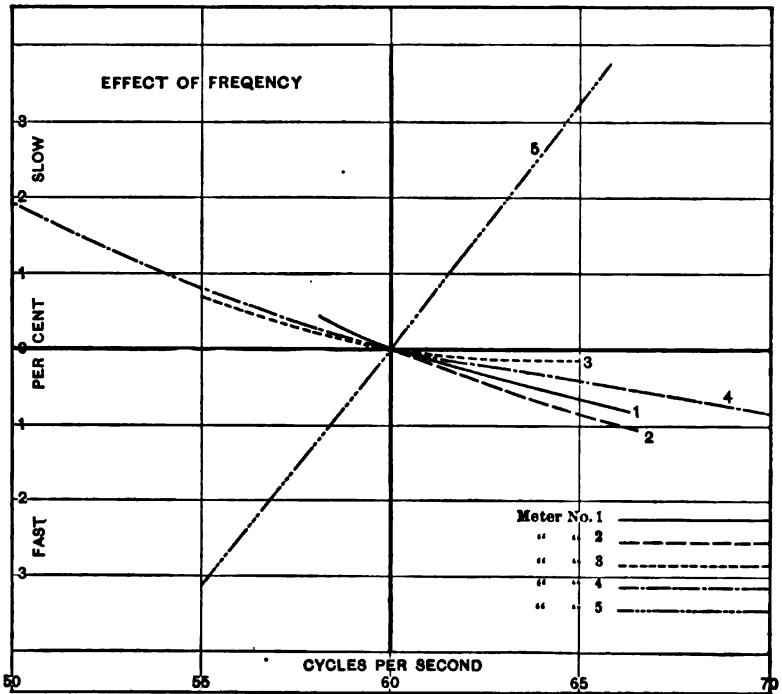

FIG. 10. Showing the variation in the rate of five induction meters with change of frequency.

Fig. 7 shows the same for 50 per cent. Only three meters were used in these experiments.

Fig. 8 shows the effect of changing the harmonic from 10 to 25 and 50 per cent, keeping the phase constant. Meters 1 and 2 show the least change in rate; meter 4 runs faster and 3 and 5 run slower and show the greatest change in rate. Fig. 9 shows for three meters the same thing as Fig. 8, except that the phase

of the harmonic is 90 deg. different. Meters 1 and 2 show relatively small changes, but both run faster on the flat than on the sine curve. Meter 3 runs nearly 3 per cent slower on the 50 per cent harmonic than on the sine.

The effect of change of frequency on the rate of the meters is shown in Fig. 10. It is relatively small in every case but one.

These results show that with suitable precautions induction meters may be made to repeat their readings very accurately, so that precision methods may be applied in studying them. They also show that the variations due to wave form depend not only on the harmonics which are present, and their magnitudes, but also on their phases.

The Bureau of Standards is now having a generating set constructed which will give all the odd harmonics up to the fifteenth, and any desired combination of them with the fundamental. When this is completed it will be used to study the effects of the higher harmonics on the rate of these meters. The results given in the paper show that for commercial purposes all the meters so far studied may be considered accurate on any ordinary wave form where only the third harmonic enters appreciably; although two meters show variations of about 3 per cent when the harmonic amounts to as much as 50 per cent of the fundamental.

DISCUSSION.

CHAIRMAN RUSHMORE: This is a very interesting presentation we have had from Professor Rosa. It emphasizes the refinements which are being made in experimental work. It is not long since most investigations took but little, if any, account of the wave-form, but with the instruments which we now have, the oscillograph and other forms of curve tracing instruments, such as the one developed by Professor Rosa, no investigation in alternating-current work is complete without a consideration of the wave-form. Those shown here this morning are almost exact reproductions of some which I have obtained from unicoil windings with variable and with even air-gaps. Not long ago there was brought to my attention some oscillograph curves of a transmission circuit containing considerable capacity in which the wave-forms from a 12-slot-per-pole alternator gave harmonics the amplitude of which approached in value that of the fundamental. The paper by Professor Rosa is opened for discussion.

A MEMBER: I would like to ask two questions: First, as to what range of loads was used in these measurements; and second, as to how the two currents were combined so as to produce no reaction—that is, no reaction-through the generator?

Dr. E. B. ROSA: These cases, Mr. Chairman, are all at full load. At least, in these figures no cases are included in which the load was less

than full load. Of course the effect would vary with the load, and that is one of the things we are going to study later; but we could hardly take up the question of the varying wave-form at the same time with variations of the other factors. If we should go through all the variations of wave-form with all the variations of load and the variations of other factors, it would multiply the work indefinitely. We thought it was better to take first the case of full load, and then, perhaps, light load afterward.

Mr. W. H. BRATT: In some work I have done in this line, I used a rather different method of combining the currents. If we represent the two sources of e.m.f., or the two different frequencies, I use a common circuit for one side. Then to a point of the circuit the meter was connected. The load was then arranged to give a very considerable fall of potential, 100 volts, and a very slight fall of potential in the meter; I could then get the resulting wave by simple synthesis, without having to consider the analysis of the final wave. I found that at times the reaction of one wave on the machine furnishing the other made the synthesis incorrect.

Prof. C. A. ADAMS: I understand the load was noninductive in this case.

DOCTOR ROSA: Of course the meters were not loaded in the usual way. A current of low voltage was put through the series coil and the potential current was from an independent source. There was not a full load as there would be in practice, but simply a full current, and the potential circuit was in phase with that current. In other words, we transformed down from 120 volts to about 4 volts, and that was on a noninductive circuit.

Dr. C. V. DREYDALE: I should like to have the opportunity of saying a few words on the very valuable paper of Doctor Rosa, although the remarks I have to make have, perhaps, rather to do with the subject he suggests taking up hereafter than the one which is now the subject of his paper. The investigations I have been making lately are on the question of the accuracy of wattmeters and also of alternating-current supply meters of various types with a variation of power-factor, not of wave-form. But as the subject is one of considerable importance, and I have not heard of much investigation on the point, I thought perhaps it would be sufficiently near the subject to permit just a few remarks here.

On the question of wattmeters, in the first place, the connections have been reckoned from time to time on a theoretical basis—and I must confess to one or two things in that way myself—but the difficulty has been in the theory that although it is fairly easy to predict in some cases what will cause errors in the wattmeter, it is not so easy, especially in the case of eddy currents, to define what the magnitude of the errors will be. It is, therefore, of value to have experimental determinations on that point, and I had the opportunity just before I left England of taking tests on various makes of wattmeters at various power-factors, and I am very pleased to be able to say that they are very much better instruments than I think most of us, at any rate in England—I do not know about America—have realized. Indeed, I may go so far as to say

that the ordinary commercial indicating wattmeter is as accurate an instrument in its ordinary range as a fairly efficient ammeter or voltmeter. I may be saying something that is not new to you here—I know it is not known in England, for the reason that we have been so often having suggestions as to the use of indirect methods such as the three-voltmeter method of measuring power, which, to my mind, are perfectly useless. The errors you get are infinitely greater than could be caused by the most inaccurate of wattmeters. At the same time I have had the opportunity of testing a few of the ordinary supply meters, but I have not the results to show you here.

Another thing I should like to refer to is the method I have been employing in making these tests. The testing of instruments at various power-factors when it has been done at all has usually been effected with the aid of two alternators, the shafts or armatures of which can be set at an angle so as to give any desired phase difference. Although this is an excellent device, it is naturally somewhat costly and difficult to obtain, and I have been therefore led to substitute for it a phase-shifting transformer, which, although from what I have recently heard it may not be absolutely novel, is certainly not generally known of, and is so extremely convenient for this important class of work that it may bear mention here.

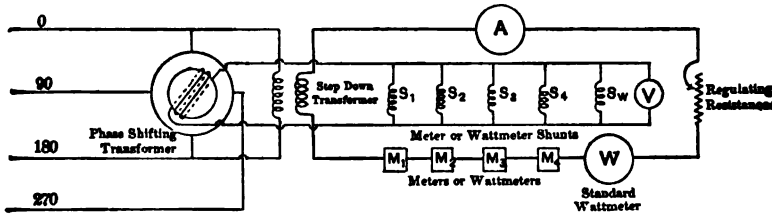

The apparatus, in the form I have had it made, resembles an induction motor with a simple two-pole winding, the outer part corresponding to the stator, being wound either with a two- or three-phase winding so as to give a pure rotating field in its center, while the center portion, which can be rotated to any desired angle, is wound with a simple diametral single-phase winding. In order to obtain as regular a rotating field as possible, the windings should preferably be made in a considerable number of nearly closed slots or tunnels, and the rotating portion may be made to fit the stator, so that the magnetizing current is very small. With such a device any desired phase rotation may be obtained by merely setting the rotating part to the corresponding angle, and a fairly close idea of the power-factor can be obtained from a permanent scale fixed to the transformer. The connections I have used in wattmeter and supply meter testing are shown in the figure, where the rotating field is obtained from a two-phase supply. The four conductors from the supply are connected to the stator of the phase-shifting transformer, and one of the phases in addition is connected to a step-down transformer which supplies current for the main coils of the standard and test instruments, while the shunt coils are supplied from the rotor or secondary.

In order to test at any desired power-factor (either lagging or leading), the rotor need only be set to the corresponding angle, and where this power-factor is required with great definiteness, the position of the rotor and the resistance in circuit are simply arranged to give the required potential, current and wattmeter readings. The convenience of having your phase-shifting device close at hand and of running several such arrangements off one supply is very great, and I am having such transformers permanently installed for meter-testing work.

I should like to point out in conclusion that as a rule in testing any wattmeter or supply meter, it is only necessary to obtain readings at the two extremes of unity and zero power-factors. The different inductive errors to which such instruments are liable manifest themselves in two ways: (a) in the alteration of the current in the shunt coils of the instruments, and (b) in shifting its phase. The first of these effects is shown at unity power-factor, as small phase displacements have practically no effect in this case, while at zero power-factor the phase displacement is the only error of importance. It is therefore extremely convenient to be able, by such an apparatus, to set the potential and current in phase in the first place and check the readings of the instrument, and then afterwards to swing the rotor round until the standard wattmeter reads zero, when of course any instruments under test should likewise show no reading. It will be found in some cases, especially with supply meters, that a reading is obtained either in the forward or the backward direction, and the behavior of instruments under these conditions is extremely interesting.

DOCTOR ROSA: I might be allowed to say, perhaps, that we have in the laboratory at the Electricity Building at the World's Fair a phase-shifting device such as Doctor Drysdale has described, which is very convenient indeed as a laboratory device and perfectly satisfactory in many cases. We do not find, however, that it is as accurate, if we wish to shift the phase by a certain amount, as to shift the field or armature on the generator; and we have another set, a generating set consisting of two machines, one giving the same frequency of current as the other, one to be used for the main current of the wattmeter and the other for the potential current, in which we can shift the phase by a hand wheel while the machine is running, a graduated circle showing the angle through which it is shifted. The circle can be read to a very small part of one degree and can be used not only to shift the phase by a known amount, but to calibrate a phase meter through a wide range. The armature can be shifted around so that the standard wattmeter gives no deflection when you have full current flowing through it and full potential at its terminals, and that is very exactly 90 deg. difference in phase. Then advancing from that point to any amount required, you get by reading the scale a very exact measure of the difference in phase. In the case of the phase-changer when you shift it around, you are liable to vary the air-gap and the advance in angle may not be the same as the angle through which the rotating part is moved; but when two independent generators are running together and the load is constant and all the conditions of the circuit are constant, and you advance the stationary element by 5 deg., you are bound to introduce an exactly correspond-

ing change in the phases of these two currents, and that makes an excellent means of changing the phase by a known amount, and also using it to test your phase meters if you are using them. Perhaps some of the gentlemen present may be interested in seeing some of the phase indicating instruments we are using in our laboratory work, and also some frequency indicators.

I might add one word in regard to the determination of frequency. Although there are some very good instruments for indicating frequency, with which one gets by interpolation the frequency to one- or two-tenths of a cycle out of 60, we found that that was not quite sufficient, and in our meter tests we have caused to be recorded upon the chronograph every 50 revolutions of the generator along with the record of the meters, so that with the standard chronometer recording the seconds at the same time, it is possible to determine the frequency to a hundredth of one per cent. It is simply a matter of reading off from the record, after the work is done, the time for any given number of revolutions, and you get the frequency.

DOCTOR DRYSDALE: I heartily agree with Doctor Rosa's comparison of the two devices for shifting the phase. I think it is quite possible that the double-alternator method is more accurate if you require to trust to the angle, but my claim for the advantage of this arrangement was for its simplicity and for the fact that you do not require specially built alternators as long as you have the two-phase or three-phase currents. The phase-shifting transformer can be close to the apparatus you are using, not necessarily in another dynamo room; and, furthermore, I claim this has an accuracy as great as any other device, provided you set the transformer to give the required instrument readings in the way I have mentioned. I am not quite sure that even in the case of two generators you can quite trust to the phase difference between them being that between the armatures if they are unequally loaded as is generally the case in such tests. In any case my point is that the transformer is so extremely convenient and so applicable to most work (and is capable of being used with accuracy), that it is decidedly worth the using in most cases.

DOCTOR ROSA: I would like to say just a word in regard to armature reactions. The armature reactions, whatever they are, are not changed by changing the relative phases of the two machines, so that could not introduce any error at all. The two machines should not affect one another. If they are far enough apart so that they do not affect each other, then there can be no effect of armature reaction. On the other hand, this phase-shifting device, at least the one we have, changes the wave-form as it is shifted around. You can hardly build, I think, a shifting device that will not do that. If you could close the air-gap and have the windings properly distributed it would be different, but with the air-gap shifting the rotor is likely to introduce some change of wave-form.

DOCTOR DRYSDALE: I would only just say in reply, that the matter of wave distortion has been considered, and it has been eliminated very greatly by distributing the coils in several tunnels, probably as far as

is necessary for most practical purposes. Otherwise I quite agree, of course, with what Doctor Rosa says.

PROF. ADAMS: One point relating to the effect of power-factor upon the indications of movable-coil indicating meters was brought to the speaker's attention two or three years ago in connection with some high-frequency (350 cycles) low power-factor measurements. It was found that the error due to the inductance of the pressure system was not the same in different parts of the scale, owing to the variation of apparent inductance with the position of the movable coil.

DOCTOR ROSA: The discussion has drifted a little away from the original topic. We have made quite a number of experiments on the effect of power-factor on meters, and the reason they were not introduced here is that they were not fairly included in the topic of the paper. But we find a very great difference in meters. Some show errors as high as 9 per cent when the power-factor is reduced to 50 per cent, but that is an extreme case. I am referring now to integrating-induction meters. Indicating meters show smaller errors than that, and yet there are considerable differences.

PROF. ADAMS: A practical case of aggravated wave distortion frequently occurs in connection with a synchronous motor running light, for, although the difference in wave-shape between generator and motor may not be great, its effect at very light loads is very prominent. The speaker had occasion a few years ago to take an oscillograph curve of the current in a case of this sort, and the harmonics were so predominant that it was difficult to separate the fundamental wave.

CHAIRMAN RUSHMORE: If there is no further discussion of Professor Rosa's paper, we will pass on to the next. It was my pleasure years ago to attend a class at Cornell where Professor Ryan sat at the desk and presided, and I was called upon to recite. This is the first time in my experience that the conditions have been reversed. To quote from someone else, I wish to repeat a remark which I heard last year when Professor Ryan was reading a paper before the American Institute of Electrical Engineers. It was then said that people had come to expect from Professor Ryan at certain intervals a contribution to the progress of science which should be of lasting value and should represent the work of an artist in this line. It is a very great pleasure this morning to call on Professor Ryan to read his paper on "Some Elements in the Design of High-Pressure Insulation."

PROF. RYAN: It is with very great hesitation, Mr. Chairman and gentlemen, that I present this paper on the subject of the design of insulators, for the reason that, as you all know, I have no practical contact with this subject whatsoever, and have been able to come near to it entirely from the standpoint that I trust is made clear within the paper itself—that of the academic or scientific worker. Yet because there are some elements from the scientific side that I believe firmly now will be of some assistance in the high-pressure work, I have ventured to present the comments that appear in this paper, and if you will kindly follow the paper with me I will endeavor to abstract it in such a manner that you can get its context in the minimum of time.

SOME ELEMENTS IN THE DESIGN OF HIGH-PRESSURE INSULATION.

BY PROF. HARRIS J. RYAN, *Cornell University.*

Design in any line of practice involves the application of a properly trained judgment. This trained judgment can only be acquired through the enthusiasm of the specialist and as the result of a large practical experience based upon a knowledge of the corresponding science. The object of this paper is not to deal comprehensively with the subject. It is the purpose of the writer to present only those elements of modern electrical science upon which must rest the trained judgment of the designer of high-pressure insulation.

The duty of predominating importance in high-pressure insulation is to withstand electrical strains. The requisite dielectric strength in low-pressure electrical apparatus is easily attained. The difficulties in low-pressure insulation design that must be overcome are to be found in the mechanical requirements and the deteriorating influences of dust, temperature changes, moisture, etc. The judgment of the designer of low-pressure insulation is assisted only to a small extent by electrical science. Success depends mostly upon experience in regard to mechanical, factory and experimental knowledge of the various materials and expedients available for this class of insulation. On the contrary, in apparatus employing the higher electrical pressures in commercial use, great difficulty is encountered in the provision of insulation that has ample dielectric strength to withstand continuously the electric strains that are encountered. For these reasons the following methods and data are useful in the design of insulators to withstand high electric pressures:

1. A convenient system for fixing quantitatively the flux of electric force produced by an e.m.f. in a dielectric, causing the electric strain therein.
2. The permeability of an insulation to flux of electric force produced by e.m.f.

3. The density of flux of electric force which the ultimate electric strength of the insulation is called upon to withstand and at which rupture occurs.

4. Expedients that localize the application of the electric strain within those portions of an insulating system that are most powerful and capable of standing the total strain.

5. Experimental methods for testing the dielectric materials:

a. For the construction of insulation so as to secure their breaking strains, that is, the densities of electric force flux at which their ultimate rupturing strengths are developed.

b. For testing completed insulations or insulators to determine: 1.) The manner in which they satisfy the requirements. 2.) To determine design factors.

6. Factors of safety.¹

These topics will be treated in the order given above.

1. FLUX DUE TO E.M.F.

In order to make note of a convenient system for fixing quantitatively the flux of electric force produced by an e.m.f. in a dielectric causing therein electric strain, it will be necessary first to consider:

The Behavior of a Dielectric when Subjected to Electric Strain.

When the terminal faces of a dielectric are in contact with conductors between which an e.m.f. is applied, an electric force is exerted throughout the dielectric in variable degree, according to position with reference to the conductors. This electric force produces a distortion of the atomic structure of the dielectric; i. e., a displacement of the electrons forming the dielectric atoms. Such electron-displacement, while in progress, constitutes an electric current. The displacement encounters the reaction due to internal atomic forces which tend to maintain the original structural form. This reaction is the cause of the formation of the familiar counter e.m.f. of a condenser and is in proportion to the total amount of electricity or the time-integral of the current that was passed through the dielectric. When the process of atomic distortion proceeds beyond the point of structural rupture, the ordinary conduc-

1. Determined by trained judgment.

tion current ensues. Thus through a dielectric prior to the rupturing point the only current that can be passed is a *displacement current*.² The passage of such displacement current and the establishment of the corresponding field of electrostatic force are merely cause and effect in one and the same operation. In any portion of the dielectric the value of the strength of the electrostatic field of force therein established is proportional to the displacement of electricity, i. e., to the time integral of the displacement current that accompanied the establishment of such electrostatic field.

“For engineering purposes, therefore, the time-integral of displacement current³ may be conveniently employed as a measure of the strength of the corresponding electrostatic field of force.”⁴

For convenience, *strength of electrostatic field of force or density of flux of electric force* will be referred to as the *density of dielectric flux*.

2. INSULATION PERMEABILITY.

A convenient designation of the permeability of an insulation for dielectric flux is based upon the above facts as follows:

The specific inductive capacity of a dielectric is the ratio of the displacement current set up through such dielectric to that set up through air under the same conditions with respect to the electrodes and the e.m.f. Thus when the displacement current for a unit volume of air subjected to a strain of unit e.m.f. is known, the corresponding displacement current becomes known for any dielectric for which the specific inductive capacity is known.

“The energy that is taken up in the formation of an electrostatic field of force through a dielectric and which has been applied, therefore, in the passage of the corresponding time-integral of displacement current, is

$$J = 1/2 C E^2 \quad (1)$$

where C is the capacity in farads; i. e., the coulombs of displacement current per volt.

2. An exception must be made in regard to the tiny current that will pass conductively through all dielectrics, gases, liquids or solids when subjected to electromotive forces, generally understood to be carried by the free electrons that reside to a small extent in all dielectrics. These currents are so small for gases and the powerful solid and liquid dielectrics when homogeneous and free of all conducting matter, that for engineering purposes they may be entirely neglected.

3. In engineering this is called the *charging current*.

4. “The Conductivity of the Atmosphere at High Voltages,” by H. J. Ryan. *Trans., A. I. E. E.*, Vol. XXI, p. 280, 1904.

When an e.m.f. of *one volt* is applied to the opposite faces of a centimeter-cube of air at ordinary barometric pressure and temperature, the energy taken up by the electrostatic field formed thereby throughout the cube will be

$$441.7 \times 10^{-10} \text{ joules.}$$

No important change in this value occurs with variation of barometric pressure and temperature. When it is substituted in equation (1) the corresponding strength of electrostatic field thus produced per volt per centimeter of air expressed in coulombs of displacement current per square centimeter is found to be

$$C = 883.4 \times 10^{-10} \quad (2)$$

It may, therefore, be stated with reference to the dielectric permeability of air that:

*"One volt applied through a distance of one centimeter in air will establish a dielectric flux density of 883.4×10^{-10} coulombs per square centimeter."*⁵

Thus the product of this dielectric flux constant for air and the specific inductive capacity of an insulation will be the corresponding dielectric flux constant for that insulation.

Where the specific inductive capacity of an insulation is not known, it can be determined in the following manner:

The sample of insulation should be formed into a sheet of uniform thickness. Suitable disc electrodes are applied to either side of the test sheet. The charging current is measured which is made to pass between the electrodes through the test sample by an alternating e.m.f. of known wave form and value. To avoid the error due to the fringe of dielectric flux at the edge of the electrode, a guard ring should be employed similar to that used in an absolute electrometer. Care must be taken to connect such guard ring to the circuit in such a manner that it will not accept charging current through the current-measuring instrument. From the dimensions of the test sample and the guarded electrodes, the values of the current, e.m.f. and the time, *the coulombs of charging current per volt per unit cube are easily deduced.*

Since a certain amount of electric strain in a given insulation is due always to the passage through it of a certain quantity of elec-

5. "The conductivity of the Atmosphere at High Voltages," by H. J. Ryan. *Trans. A. I. E. E.*, Vol. XXI, p. 281, 1904.

tricity per unit cross-section, it follows that the permeability constant derived as above will enable one to predetermine the strains that are produced by the application of a given amount of electric pressure when the forms of insulation are simple. This is a means whereby the judgment may be greatly assisted or improved in designing insulations where the dimensions are too complex, as is generally the case, to admit of exact calculation of the electric strain.

It may be well to call attention to the relation between the electrostatic capacity that exists between any pair of electrodes and the dielectric flux that an e.m.f. applied between them will establish. The capacity is equal to the coulombs of charging current per volt applied between the electrodes and is, therefore, numerically equal to the dielectric flux established per volt applied between such electrodes. Where the dimensions of the electrodes and dielectrics are simple enough to admit of handling them mathematically, dielectric flux densities, i. e., electric strains may, therefore, be easily calculated from the value of the capacity; and *vice versa*, the capacity may be calculated from the dielectric-flux constants.

3. DISRUPTIVE FLUX.

The dielectric flux density at which the resulting electric strain becomes sufficient to produce structural rupture for a given insulation under definite conditions as to temperature and mechanical pressure must be observed by experiment. In making break-down tests of this character some care must be taken in arranging the test sample so that the distribution of dielectric flux is uniform throughout the portion of the sample in which the rupture is made to take place. This is a condition in the present state of the technology that is rather difficult to obtain. It is highly desirable that the dielectric medium in which the test sample and electrodes are immersed should be dielectrically more powerful than the sample under test. It is difficult to make a reliable break-down test of a powerful solid dielectric in the ordinary atmosphere. This is due to the fact that the ultimate breaking strength of the normal atmosphere is small compared with the breaking strength of the test sample.

When the test is conducted in the normal atmosphere, it is impossible to subject the sample to strain without at the same time straining the air about it or in contact with it. Unless great care

is used in arranging the test sample the air will break, conduct and heat injuriously the sample when subjected to strains that are much lower than the strains at which such sample will be found to break if tested in a manner so as not to be injured by the intense heat of the conducting atmosphere.⁶ This is quickly demonstrated by making a break-down test of sheet hard rubber mounted between the test electrodes first in the normal atmosphere and then in air, for example at a mechanical pressure of 20 atmospheres. The dielectric strength of air in the latter case is quite on a par with that of the hard rubber which will then rupture because of the electric strain and not because of injury by heat.

There is much to do in this branch of electrotechnics in the development of convenient and satisfactory methods for testing insulations to determine the actual dielectric flux densities or electric strains that produce rupture.

4. INSULATION EXPEDIENTS.

Every portion of a high-pressure circuit is covered with insulation that is permeated everywhere by dielectric flux causing corresponding strain. The quantitative nature and distribution of this flux is entirely similar to the corresponding features of magnetic flux and should, therefore, be easily understood. Dielectric flux is established as tubes of electric force through the insulation between the conductor surfaces in proportion to their corresponding differences of electric pressure.

Thus it is evident that the greatest dielectric flux densities must occur in those zones of insulation that are next to the conductors of the electric circuit. This must be so since the total flux through any outer zone surrounding the circuit must be the same as that through the zone next to the circuit. Since the sectional area determined by the latter zone must inevitably be smaller than the sections at corresponding outer zones, it follows that the density of the dielectric flux will be greatest in the zone-sections next to the high-pressure conductors. This fact would indicate that in rational design the insulation next to the conductor surfaces of high-pressure circuits should be formed of the most powerful dielectrics. Unfortunately, structural requirements generally make this impracticable.

6. It is assumed that all test pressures are alternating.

For example, in Fig. 1, there is given a section of an armature slot containing two coils of a high-pressure alternator, 10,000 to 15,000-volt class. The conductor from which these coils are made is given an insulation covering that is fully capable of withstanding the electric strains due to e.m.f.'s. produced or consumed locally in that particular section of the armature circuit. This may be called the *minor insulation*. It is determined in the main, as are all low-potential insulations, so as to meet structural and mechanical requirements without undue expense. Over the coil as a whole there is applied a carefully constructed covering made of the most powerful available dielectric having an ample strength to withstand continuously in practice the strains due to the total e.m.f.'s. generated in, or applied to, the circuit of this armature. This outer covering may be called the *major insulation*. While this represents the best



FIG. 1.

practice that has as yet been attained, it contains one element of serious weakness as follows:

The dielectric flux starts from the surface of the outer conductors and traverses the minor and major insulations in series and stops at the surfaces of the slot. Note the relative values of the densities of dielectric flux passing the two concentric zones in the insulation about the coil; the inner zone is located by the irregular outer surface of the conductors of the coil and the outer zone by the regular walls of the slot. The dielectric flux passes from the surfaces of the outer conductors of the coil to the walls of the slot and in so doing traverses these zones. It passes the inner zone at considerable irregularity in density and the outer zone at a much more nearly uniform density. The sectional area determined by the inner zone is considerably less than that determined by outer zone. From these two classes of facts it follows that the maximum dielec-

tric-flux densities to which the insulations are subjected are considerably greater for the minor than for the major insulation. This is decidedly unfortunate; better results would be obtained with the conditions reversed.

Due to these facts it follows that in practice of this class the major insulation, without sacrificing break-down strength and structural character, should have the lowest attainable permeability to electric force, i. e., the highest attainable specific reluctance to dielectric flux. This is needful in order that the total dielectric flux established from the surfaces of the outer conductors of the coil to those of the slot shall be limited so as to be well below the point at which the maximum dielectric flux density encountered in the minor insulation will not be sufficient to cause its rupture.

The minor insulation is invariably porous, containing air or other gases at normal atmospheric pressure. Comparatively low densities of dielectric flux are required, therefore, to rupture minute volumes of the minor insulations, which will then conduct the charging currents, causing rapid deterioration through heating and other physical and chemical effects. The thickness of powerful dielectrics having low specific inductive capacities that must be applied in order to maintain all dielectric-flux densities low enough so as not to injure the minor insulation becomes so great as to be impracticable in the present stage of the industry for machinery construction at higher pressures than 15,000 volts. In all high-pressure apparatus, whether of the machinery or transformer class, the inevitable dielectric flux is established in like amounts serially through the major and minor insulations. Owing to structural difficulties the minor insulation is far inferior in strength to the strength of the best dielectric available for the major insulation. It is on this account that such an enormous amount of dielectric of high reluctance to dielectric flux must be used in the construction of the major insulations of dry or "air-insulated" transformers. The amounts of major insulation that must be used are excessive taken with respect to that which should be ample to withstand in practice the electric strains produced by the normal, or ordinarily abnormal, electric pressures.

It is the experience of reputable makers that the air-insulated transformer is impracticable for pressures higher than about 35,000 volts; space and materials cannot be afforded to limit the dielectric flux sufficiently at higher pressures.

Oil may be used successfully for the generation of the highest pressures desired in practice. By proper treatment in its preparation for use in submerging the high-pressure transformer, and by proper construction of the solid or supporting insulation of the transformer-conducting circuit, all air and other gases may be displaced. The oil and solid insulations thus form a combined or composite major and minor insulation having great dielectric strength at all points.

Even with the most approved use of oil, however, the conditions are not exactly ideal. The dielectric flux emanates with greatest density from the surfaces of the outer conductors of the terminal coils, owing to the fact that the zone-section at this point is the smallest and the density of dielectric-flux distribution the most variable. The result is that the chief electric function of the oil is to limit the dielectric flux to within the point at which the maximum flux density that will emanate from the surface of the conductors of the high-pressure circuit will be safely within that which the composition of oil and fabric next to the conductors will stand. Times will come in practice when the high-pressure circuit of the transformer must stand excessive pressures applied from without or developed within by complex impedance phenomena during short-circuits or open circuits. Thus occasionally and momentarily the insulation next to the conductors will be subjected to strains due to dielectric-flux densities that exceed the breaking point causing a corresponding momentary conduction, heating and injury. Such injuries initially are often very small, yet they are cumulative, for their cause is recurrent and their location is the worst possible.

In this analysis one is led, therefore, to the conclusion that a rational solution of these difficulties applicable alike for "air-insulated" and "oil-insulated" high-pressure apparatus consists in the employment of metallic guards or envelopes closely surrounding the coils or sections of the circuits of such high-pressure apparatus for the purpose of relieving the minor insulation of all electric strain due to normal operation. To relieve it further of those highly localized strains that are due to complex impedance phenomena that accompany short-circuits, opening circuits and similar punishing circumstances, an undue local rise of potential difference in the individual coils may be prevented by the attachment of properly chosen spark arresters to the terminals of such individual coils. The real function of the metallic guard is to form

a conducting envelope about the individual coils of the high-pressure circuit to which to conduct the inevitable charging current and from which the corresponding dielectric flux starts through the major or powerful dielectric at an average lower and more uniform density. The guard must be connected to one terminal of the coil that it protects, and it must be constructed in such a manner as to avoid the circulation of current. Obviously these guards and spark arresters may be applied much more easily in transformers than in machinery. By their use it should be possible to make successful transformers for the use of the highest electric pressures that the transmission lines of the future can successfully carry.

We have seen that it is irrational to expose the minor insulations to the great electric strains which powerful major insulations are alone calculated to stand. So long as the major insulation must be designed for sufficient reluctance to limit the dielectric flux to a value that the minor insulations can safely stand, there is no rational relation between the amount of major insulation required, its ultimate break-down strength and the normal working pressure of the high-potential circuit. When, however, the electric strain is carried past the minor insulation and applied properly only to the major insulation, there appears at once a rational relation between the normal working pressure and the ultimate pressure required to rupture such major insulation.

5. TEST OF INSULATING MATERIAL.

In all classes of tests to be made which are here referred to, measurements must be made that will determine the value and wave forms of the applied e.m.f. and charging current and their phase relation. The maximum value of the electrical pressure wave applied between a conducting cylinder and a wire mounted at its center that produces luminous conductivity observed by the eye in the zone of air next to the wire is definite at definite barometric pressures and temperatures. This promises to be an acceptable method for determining the maximum value of the wave of high pressure applied in this class of testing. The wave forms are most easily observed by means of the cathode ray wave indicator. When they are not too irregular the oscillograph may be used in lieu of the wave indicator.

A satisfactory indicating wattmeter is much needed for the ready detection of conduction due to rupture of gas bubbles or other weak foreign dielectrics in the sample under test. It is useful also for the purpose of measuring the total watts consumed by the charging current at any stage of the test. Any sensitive wattmeter of the dynamometer type and of excellent construction, having a suitably fine field winding, will give correct results, provided the non-inductive resistance used for the pressure circuit be properly protected from the delivery of the inevitable capacity-charging currents. Such charging currents, if allowed to pass to and from the surface of the pressure-circuit resistance, produce errors of an entirely uncertain character for which no satisfactory correction can be made. Since these capacity currents may not be avoided they must be made to pass from guards supplied independently with potentials correspondingly equal to the potentials of the respective sections

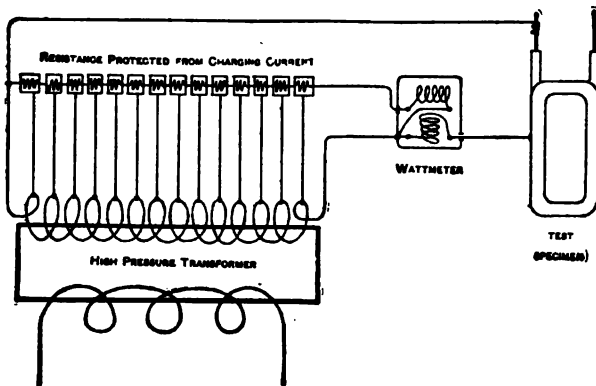

FIG. 2.

of the pressure-circuit resistance about which they are mounted. Two obvious methods for accomplishing this are illustrated by the diagrams which explain themselves in Figs. 2 and 3.

The diagram of Fig. 2 illustrates the method for protecting the resistance of the pressure circuit from capacity-charging currents wherein the transformer furnishing the high-pressure test currents is near at hand. In this transformer the high-pressure circuit is divided into as many sections or coils as there should be guarded sections in the high-pressure resistance circuit of the wattmeter. When this sort of high-pressure transformer is not at hand the method given by the diagram in Fig. 3 may be employed.

Across the terminals of the high-pressure source there are connected in series as many small auto-transformers as there are to be guarded sections in the pressure resistance circuit. Each of these auto-transformers must have a normal e.m.f. rating as great as its share of the total pressure; it should be mounted upon a high-potential line insulator of a form suitable for the total pressure employed. These auto-transformers are connected to corresponding resistance guards as shown, bringing them to the potentials

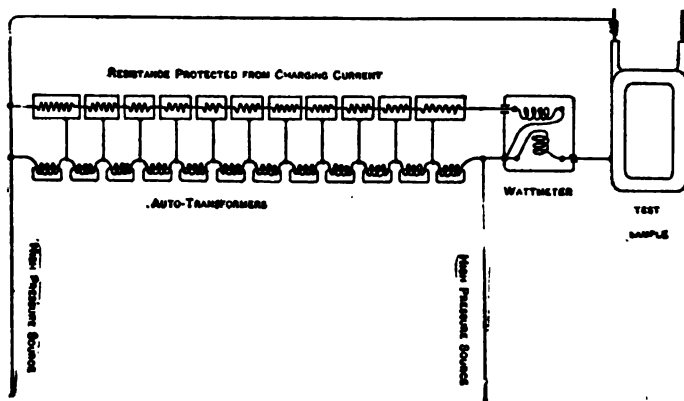

FIG. 3.

corresponding to those of the resistance sections over which they are mounted so as to protect them from the delivery of charging current. As the diagrams of Figs. 2 and 3 show, the wattmeter must be covered with a metallic guard net connected to the proper side of the circuit so as to relieve it also of the delivery of all charging current. A wattmeter mounted and used in this manner must give reliable results in the observation of *pressure-loss characteristics of insulations*.

The nature of such characteristics is illustrated in Fig. 4.

Characteristic No. 1 is that of an insulator which is homogeneous and continuous between the conductors and wherein the strain is distributed with some approach to uniformity.

No. 2 is the pressure-loss characteristic of an insulator wherein there are portions that are weak or the dielectric flux is distributed very irregularly, or both.

No. 3 is a characteristic taken from a composite insulation made up of strong and weak dielectrics as found for example in a paper insulated cable.

In conclusion, the writer wishes to call attention to the fact that these scientific elements that are useful in the production of high-pressure insulations have long been known. What is really little known, however, is the association of ideas necessary to apply them. Attention may properly be called to the fact that a far less proportionate use of mathematics can be made in determining necessary dimensions in the design of insulation than is the case correspondingly for either of the other two components of electrical machinery and apparatus, viz., the circuits accommodating electric current and magnetism.

The great majority of practical problems for solution by calculation that arise in connection with the conducting circuits or the

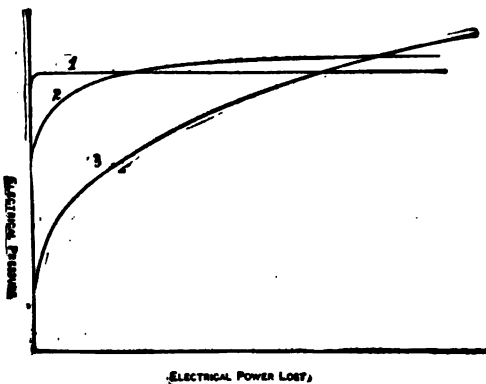

FIG. 4.

magnetic circuits are easily possible because of the definite density distribution of the current or magnetic flux in their respective circuits. From the inherent nature of things the density distribution of dielectric flux through the insulation is definite only in a few forms of electrical apparatus, as for example through the insulating sheets of condensers, except at the edges of their electrode coatings, or throughout the atmosphere about a transmission line. In the great majority of cases the distribution of the dielectric flux is too complex to admit of the reduction of accurate results by the simpler mathematical processes. The judgment supplemented by the results of tests and measurements made upon test samples, specimens or models must, therefore, make up for lack of calculating methods.

DISCUSSION.

PROF. C. A. ADAMS: The engineering profession owes a great debt to that man who has lifted ever so small an area of engineering method out of the empirical, rule of thumb, hit or miss realm, into the rational, scientific realm. This is what Professor Ryan has done to the large and very important field of high-voltage insulation.

MR. E. KILBURN SCOTT: It has always seemed to me that the greatest trouble we have with insulation is in the smaller sizes of motors and static transformers. For instance, if you wind a motor, say, of 3 hp for 500 volts or higher, the wire becomes quite small, perhaps No. 25 British W. G., and when you insulate so small a wire, the bulk of the space in the slots is occupied by the insulation. A 3-hp carcass, wound for 110 volts, may be well over power; but if wound for 500 volts, the chances are it will run hot, simply because of the extra space required for the insulation. The question is, what are we to do? Well, it has occurred to me, and has been suggested, I believe, by others, that it might be feasible to use other material than copper for the conductors. For example, why should we not use iron, and so reduce the number of our conductors, while at the same time increasing their size, so as to obtain a cross-section which is capable of being handled by workmen? Iron wire, one-sixteenth inch in diameter, would be much more easily handled by the ordinary workmen than No. 25 British W. G. copper wire. It is true that the periphery of the larger wire requires more insulation to go around it, but, inasmuch as the iron would be carrying magnetic lines as well as current, the number of wires for a motor of given output would be considerably reduced, and I think that on the whole the net result would be that the space occupied by the insulation would be less. Perhaps the carcass would be larger, but there is something very attractive in the idea of an all-steel motor.

My ideal of an electric motor of, say, 3 hp for driving machine tools would be one made entirely of steel, cast iron, mica and japan. I would even propose cast iron for the commutator segments; because the commutator for such a motor is very much larger than the conditions of electric conduction demand. However that may be, I do not see why we should not use in the smaller sizes of direct- and alternating-current motors japanned iron wire, and do away with the very unmechanical cotton, paper, and fibrous materials.

CHAIRMAN RUSHMORE: I desire to add a few remarks in the way of appreciation of the work which Professor Ryan has done. Practically all of my experience has been in the manufacture of electrical machines and apparatus, and I know that the question of insulation has long received more or less scientific treatment. Experiment has shown the resisting properties of various insulating materials, but a clear understanding of their action has not been obtained. There is probably no line of research that is being pursued at present with greater interest and with more possibilities than is the subject of insulation. It is at present the limiting feature in electrical development, and especially in the engineering and commercial features of power transmission. Within

the last year, cotton insulation on wires has been in many cases dispensed with, the insulating material being placed directly on the metal conductor.

A point in Professor Ryan's paper which I wish especially to comment upon and which one does not always hear from a man in university work is, that the design of electrical apparatus necessarily involves the application of judgment and experience. In contrast to this was a view taken by a writer not long since, in giving methods of the design of electrical machinery, in which it was remarked that with the information given anyone could design electric generators without experience.

Quite recently an expert on the subject of insulation was discussing the question as to whether or not dielectric hysteresis had any actual existence, and I should like to hear from Professor Ryan on this point. It is found in practice, as he stated, that with the same applied potential the insulation is much more heated when this is alternating than when direct, but is there any real evidence to show that we have hysteresis in the dielectric? The question of insulation as used in electrical machinery is not altogether one of the electrical properties of the materials, because a number of these having sufficient dielectric strength are not used owing to lack of mechanical qualities, which allow them to deteriorate under the constant vibration to which they are subjected. Micanite may be taken as an example of this. Several years ago mica-nite was much used for high-voltage insulation, but by reason of its deterioration under vibration and high cost it has, to a considerable extent, been replaced by other materials. Professor Ryan mentioned the use of oil, and this in its different forms is the principal insulating material now used. We have the oil in its natural form in the transformer, the oiled cloth, which is an almost universal application as an insulating material, and the enamel, which is oil in another form.

PROFESSOR RYAN: Might I say just a word with regard to dielectric hysteresis to which you refer. While I believe that dielectric hysteresis undoubtedly exists, that there is such a thing, yet in all the endeavors that we have made, we have always found in hunting down the source of heat in an insulation subjected to electric strain, that it was due to the breaking down of some weak constituent element or foreign body, gas, or whatever it may have been, in the insulation. As soon as such portions of the dielectric are broken, in lieu of the passage of displacement current, which accompanies the phenomena of electric strain, there is the passage of actual electric current, as we ordinarily know it, producing heat.

CHAIRMAN RUSHMORE: If there is no further discussion of Professor Ryan's paper, we will proceed in logical sequence from the instruments used in measuring the power over the insulators on which the power is conducted to the machines which utilize it, and I will now call on Mr. Day to read his paper on "Electrical Motors in Machine-Shop Service."

ELECTRIC MOTORS IN MACHINE-SHOP SERVICE.

BY CHARLES DAY.

I intend to consider the subject "electric motors in machine-shop service" from the standpoint of the shop engineer, whose one thought is economy in the broadest sense of the word. To such a man the motor is but a single detail of the equipment — possible one of the most important details, but only so when its relation to the problem, as a whole, is understood. The development of alloy steels, permitting of cutting speeds from two to four times as fast as was heretofore possible, requiring, in many instances, machines of new design for its operation, the introduction of the grinding machine, which is rapidly replacing the lathe for much finishing work, the milling machine, the electric motor as a means of driving, and types of management to assure efficient use of equipment, are among the most important factors requiring his attention.

The manufacturers of electrical apparatus too often defeat their own ends by overenthusiasm, or, rather extravagant claims that they cannot possibly substantiate. There is no use trying to convince the shop engineer that the words "motive drive" are synonymous with "low cost," for he knows that efficiency attained depends upon the co-operation of a multitude of things, and primarily the intelligence with which the equipment is handled. If the possibilities of the motor drive are properly presented, however, he can better appreciate them than any one else, for they fill a definite need, the importance of which he will understand.

It is not necessary to dwell upon substantial progress recently made in shop practice, which has resulted, in many instances, in greatly increased output with consequent reduction in cost. I will consider rather what is needed to increase efficiency in the average shop, where it is still extremely low, for even when adequate funds are provided for the purchase of new equipment, the end in view is often defeated through lack of proper insight in connection with its purchases, installation and use.

[590]

At the same time electrical manufacturers have not made the progress that would have been the case if they possessed a thorough understanding of shop requirements. Our experience has been confined largely to the installation and operation of electrical equipment under working conditions, so I will treat the subject from this side, with the hope that I may bring before the manufacturers more clearly the conditions they must meet, and at the same time aid the customer in specifying his requirements and securing results.

Generally speaking, the electric motor (either for group driving or individual operation of machines) is conceded as the proper means of power distribution. My paper will deal with the subject under the following headings:

- (1) Shop Requirements.
- (2) Notes Concerning Motor-Drive Systems.
- (3) Notes Concerning Different Makes of Apparatus.
- (4) General Conclusions.

(1) SHOP REQUIREMENTS.¹

Tools for removing metals will be further subdivided as follows: Cutters, millers, drills, etc.

My paper will only permit of a general outline of shop considerations bearing on the subject; these are illustrated in Fig. 1. Each factor must be carefully considered and when treating the subject generally certain assumptions made. For example, we are justified in assuming that the best tool steel should be used and design accordingly, while crane service and type of workmen are, on the other hand, matters depending on class of work handled and local conditions.

An intimate knowledge of shop practice is quite as necessary to the designer of electrical apparatus for machine *driving* as to the builder of the machine, and, while frequently difficult to show the direct bearing of the various features of management and methods

1. The words "machine" and "tool," as used in connection with machine-shop work, are very frequently ambiguous. I will use them in the following sense: *Machine*.—Definition (Standard Dictionary). Any combination of inanimate mechanism for *utilizing or applying power*. A construction for mechanical production or modification. Example—Lathes, pneumatic drills, power shears, etc. *Machine Tool*.—This term is often confusing and need not be used in present paper. *Tool*.—Definition (Standard Dictionary) A *hand instrument*. Not a mechanism. Used directly for production. Examples.—Chisel, hammer, saw, etc.

upon a single factor, such as the one under consideration, the most useful conclusions can only be drawn by those familiar with the subject in detail. Improved systems of management are doing much to assure proper use of equipment, but in any event the need of explanation in connection with its operation should be eliminated to as great a degree as is possible. In other words apparatus should primarily be designed to give satisfactory results in the hands of average workers. Where its adjustment and manipulation is dependent upon the operator, he must be fully considered in the design, but when attention is required for inspection at intervals only, the personal equation does not enter into the problem to as great an extent. Lathe and elevator drives illustrate the two cases.

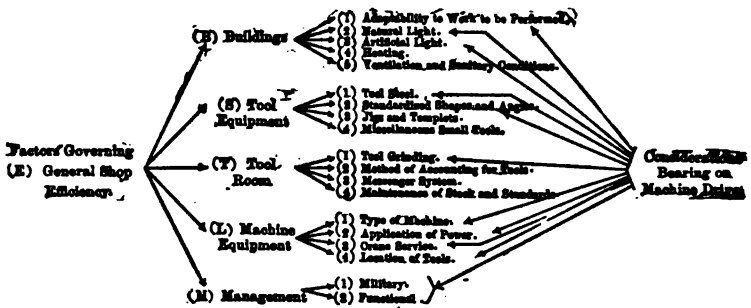

FIG. 1.—SHOP CONSIDERATIONS BEARING ON MACHINE DRIVE.

If cuts are of long duration cutting speed can readily be determined by experiment, but this is not practical in the run of machine-shop work. The determination of cutting speed for miscellaneous work is a difficult matter, and must be given special study in each case, every means toward uniformity of product being resorted to.

The drive is but a detail of the machine. We should aim at a harmonious whole, not combining an efficient drive with an out-of-date tool. The motor-driven tool of the future should not be considered a combination, but a *unit* suited for certain specific ends. The motor-drive problem is essentially a matter for the machine builder to settle, and when a machine is purchased the customer should have the assurance *that the drive has been given the same care in design and construction as any other part of the machine, and need not be considered as a distinct issue.*

Machine shops may be broadly classified according to character of output as follows:

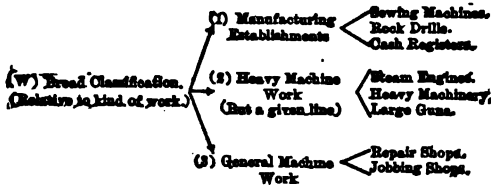

FIG. 2.— GENERAL MACHINE SHOP CLASSIFICATION.

Shops of the first class can be laid out in every detail with regard to a definite need. Machines are purchased to do just one job, and frequently it pays to design special machinery for such duty. After it is properly adjusted for the character of material to be worked and for the cutters, no changes are required until better methods or facilities are developed. Here, as far as the drive is concerned, we find the simplest conditions. Usually constant speed with adequate power suits the case.

In shops classified under the second heading, little opportunity for duplication, in the sense just considered, exists. Machines must handle a variety of work, and even those purchased for specific operations are usually suited for other purposes so they may be kept busy the greater part of the time. Variation in size of work, material and cutters, demands an adjustable speed² drive, together with change feeds, if most economical results are desired. This is true to a still greater degree for machines in the third class.

The drive requirements from a consideration of work to be performed can be further analyzed as shown below:

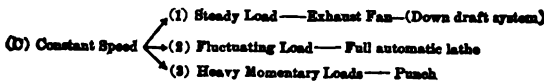

FIG. 3.— CHARACTER OF LOAD FOR CONSTANT SPEED DRIVE.

2. The words "variable speed" are now generally used to describe motors adapted for individual operation of machines, but to distinguish from the crane motor, for example, which is truly the variable-speed type, I will use the words "adjustable speed" as describing a fixed speed capable of adjustment over a given range. Variable speed motors are used principally for railway and crane service where the load is intermittent and torque variable. Direct-current apparatus has been developed to give such thoroughly satisfactory results for this duty that I will not consider it other than in its relation to the general machine-shop problem.

Chart Figs. 3 and 4 relate to *character* of load. Figs. 5 and 6 are a further analysis of adjustable speed drive, for machines using cutters, giving details that should determine "RANGE" and "NUMBER" of speeds.

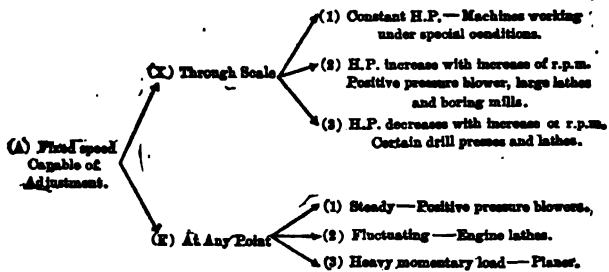

FIG. 4.— CHARACTER OF LOAD FOR ADJUSTABLE SPEED DRIVE.

Adjustable speed may also be desirable on grinding machines, and in this case will depend on ratio of maximum to minimum

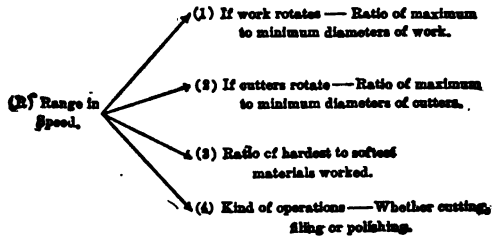

FIG. 5.— FACTORS THAT INFLUENCE RANGE IN SPEED.

wheel diameters and other matters that must be separately considered in individual cases.

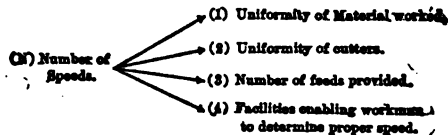

FIG. 6.— FACTORS THAT INFLUENCE NUMBER OF SPEEDS.

Machines for punching and shearing, while usually arranged for constant speed, frequently require an adjustable-speed drive. For example, assume a punch operating at 28 strokes per minute. The operator may have work of such a character that he can easily punch

a hole each stroke, while in another case, due to heavier sheets or greater accuracy required, he is compelled to skip every other stroke, so punching but 14 holes a minute, while if the machine would permit he could readily do 22. Such a saving on this class of machinery usually yields a large actual return as the time required for setting up or making ready is, as a rule, small.

The amount of horse-power required for machines of different types depends on the factors given in chart Fig. 7.

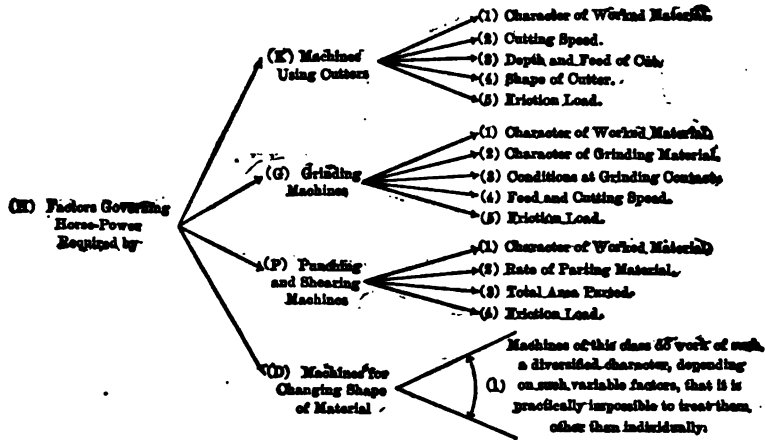

FIG. 7.— FACTORS GOVERNING HORSE-POWER REQUIRED FOR DIFFERENT TYPES OF MACHINES.

I have given the principal items to consider when designing or selecting machine drives, but to more fully explain the line of reasoning that should be followed, I will assume definite conditions, and consider the equipment needed to fulfill them.

EXAMPLE.

LATHE for general work in shop of A. _____
 B. _____ Company, manufacturer of air compressors.

General features of this plant and its organization that influence type of drive (see Chart Fig. 1).

E.B.—1. The machine under consideration is to run in an old plant, so no saving in cost of buildings could be effected by type of drive.

E.B.—2. The natural light at point where lathe is to be located is very poor, so it is important not to obstruct it any more than absolutely necessary.

E.B.—3. Artificial light has in the past been supplied by independent company, but they desire to install a power plant that will take care of this feature as well as power. It is desirable to depend largely upon general illumination by arc lamps with incandescent lights for detail work.

E.S.—1-2, and E.T.—1. For roughing work the best alloy steels, forged, treated, and maintained by special department, assuring uniformity and high efficiency, will be used.

E.L.—1, 2, 3, 4. Character of work necessitates constant use of power crane, making overhead belting and fixtures objectionable and difficult to provide for on account of location in main bay of shop. As cost of power in this plant amounts to less than 3 per cent of total cost of product, it is not a determining factor in character of drive.

E.M.—2. The type of management being introduced at this plant should ultimately assure intelligent direction of work and proper use of equipment.

Referring to chart Fig. 2, we find that this shop will come under the class indicated by the symbol *W-2*.

Referring to chart Fig. 4:—

(*A*)—*X-1-F-2.* Majority of work (probably 80 per cent.) will be steel and gray-iron castings between 18 ins. and 48 ins. diameter. Maximum conditions call for removal of same amount of metal between these limits, and approximately constant cutting speed. Maximum horse-power requirements are consequently constant through the range, but subject to fluctuations at any one point below the said maximum.

Referring to chart Fig. 5:—

R-1. At times it will be necessary to machine work as small as 10 ins. in diameter, or as large as 60 ins. diameter; consequently a range in speed of 5:1 would be required for this purpose.

R-2. Cutters will always be stationary.

R-3. The ratio of hardest to softest material required by specification will be approximately 2:1. This will increase the necessary speed range to 10:1.

R-4. The majority of work will be roughing and finishing with cutters. Some filing and finishing with emery cloth will, however, be necessary, and for this purpose experience would dictate a cutting speed of 150 ft. per minute on 10 ins. diameter. It will be necessary to provide a cutting speed of 15 ft. per minute on the largest diameter on account of the frail character and difficulty of driving some of the castings to be machined. Total range of speed is determined by limiting conditions of a cutting speed of 15 ft. per minute on 60-in. work and 150 ft. per minute on 10-in. work. I have purposely chosen these extreme conditions to better illustrate my point. In practice a 60-in. lathe is seldom required to run at 57 r.p.m.

$$\frac{150}{10 \times 8.14} = 57.3 \quad \text{r.p.m.}$$

$$\frac{15}{60 \times 8.14} = .95 \quad \text{r.p.m.}$$

Consequently, for all practical purposes, the face plate of the lathe should run from one revolution per minute to 57 revolutions per minute.

Referring to chart Fig. 6:—

N-1. It was stated above that the character of material would vary in the proportion of 2 : 1, this being a requirement of the products manufactured. Uniformity of material, or how nearly the requirements can be attained under shop conditions, is one of the factors influencing the number of face-plate speeds.

A fully-equipped laboratory, under the direction of an able chemist, who has entire charge of the cupolas and Bessemer steel converters, assures a much more uniform product in the plant in question than is usually the case. A great deal of experiment and investigation will be necessary however before we can make definite assertions in this direction, but castings from the same pattern should not vary more than 20 per cent.

N-2. Cutter of the character indicated above (E.S-1) should not vary in efficiency more than 10 per cent.

N-3. The full consideration of this point involves an understanding of the laws governing speed, feed and cut for various materials. It will not be practical to include here full data on this detail. Hundreds of tons of steel and cast-iron have been cut up to determine these relations, and constant experiment is necessary to keep abreast of rapid improvements. I will only say that it is quite as necessary to provide an adequate number of feeds as it is spindle-speeds, and in fact a limited number of either one of these factors will give efficient results provided a very close regulation can be had on the other.

In the present instance it was not considered advisable to specify changes to the standard feeding mechanism, as this feature had been well taken care of by the builder.

N-4. As the operation of the machine is ultimately governed by the facilities at the disposal of the machinist who runs it, it is absolutely essential that this point be given most careful study. It involves practically every feature of shop system and management, and it is only under such systems as that developed by Mr. Fred W. Taylor, of which functional foremanship is but a single detail, that the conditions, as outlined above, can be fulfilled. It necessitates that the operator of the machine be informed as to the character of the material, efficiency of the cutter, proper cutting speed in consideration of duration of cut, and many other equally important factors.

So it will be seen that we cannot arrive at any data which would enable us to specify definitely the number of spindle-speeds required. Our conclusions must necessarily be based principally on experience in shop practice, and for this reason engineers differ widely in their views. For the example under consideration speeds increasing in increments of 15 per cent. are, in our estimation, quite as close as can be used to advantage. It is well, however, to err on the safe side, providing too many speeds rather than too few.

Referring to chart Fig. 7:—

H-K-1, 2, 3, 4. Maximum permissible cutting speed on steel castings will be 60 ft. per minute; on gray-iron castings 60 ft. per minute (determined by actual requirements on a large variety of work). Maximum cut, cast-steel, 3/8 in. deep, 1/16 in. feed; gray-iron, 3/8 in. deep, 1/16 in. feed. (These conditions are established by character of work.)

The experiments conducted to determine the laws governing speed, feed and depth of cut, for various materials referred to above (*N-3*) have been made available for purposes of design by means of slide rules, based on the derived empirical formulæ.

For the depth of cut and feed under consideration (cast-steel), the calculated pressure on the tool would be: 5550, or horse-power required =

$$\frac{5550 \times 60}{83,000} = 10.1 \text{ hp.}$$

H-K-5. The friction load can only be arrived at through experience and depends not only on the machine, but character and method of driving work. Experimental data on machines quite similar to the one under consideration would indicate 3 horse-power through the entire range as sufficient to allow for this purpose.

These conditions are plotted in Fig. 8. It will be noticed that the horse-power falls off on either side of the working part of the scale. While it is easy to theorize as to the horse-power required for work of various diameters, in actual practice the conditions are about as I have shown. It must be borne in mind that the machine under consideration should be primarily adapted for the majority of work that it will handle. We have assumed that 80 per cent of this will be between 18 ins. and 48 ins. in diameter, so that work outside of these limits is the exception. On small work, such as would be handled, there is not likely to be opportunity for as heavy roughing cuts, and castings over 48 ins. in diameter cannot be swung over the carriage, nor would it be good policy to aim at high efficiency at this point for the additional cost would not be justified by the saving effected on such a small fraction of the total output.

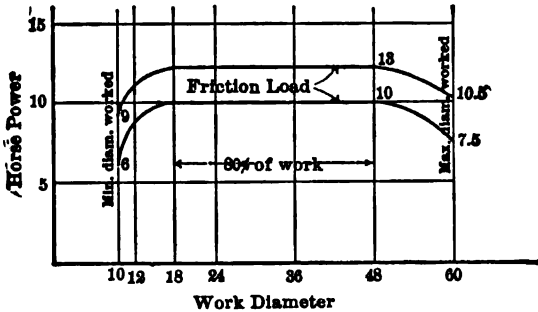

FIG. 8.—RELATION BETWEEN MAXIMUM HORSE POWER AND WORK DIAMETER TO THE A.-B.-COMPANY.

As the horse-power between the working limits shown above was figured for the maximum cutting speed of 60 ft. per minute, we can plot a relation between revolutions per minute and horse-power. (See Fig. 9.) The selection of electrical equipment for this lathe will be taken up farther on.

The analysis of conditions presented above is, as was stated, essentially a problem for the machine builder to work out — in other words, the electrical companies should look to him for general specifications covering motors and controllers.

When equipping machines of old design with motor drive, or remodeling them to better their efficiency, each one should be considered separately with regard to the special line of work it handles. As manufacturing becomes more specialized it will be possible for the builder of machines to design with more intelligence, for he can then treat a type as we have treated an individual.

To avoid going over ground that has already been thoroughly

thrued out, I will assume the following conclusions have been established.

(1) Machines of present design, for comparatively small work, requiring constant-speed drive should, in most instances be grouped and operated from motor-driven line shafts. Specifications for new machines for such duty should be made with a view to special requirements. Indirect savings in one plant may much more than offset additional cost of constant-speed motor on each machine, while this would not be true in another.

(2) For group driving, both direct and alternating-current motors give thoroughly satisfactory results. In either instance, if properly installed, repairs should not be an important feature. In certain industries — the textile mills for example — the induction

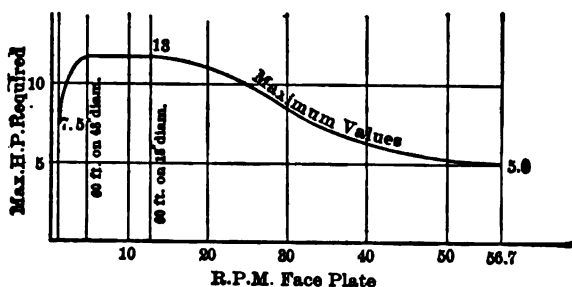

FIG. 9.—RELATION BETWEEN HORSE POWER AND R.P.M. LATHE, A.B. COMPANY.

motor has decided advantages on account of close-speed regulation with varying loads and lessened fire risk, but for machine shops these features are unimportant.

(3) Mechanical means of speed control, including step cone pulley and variable-speed countershafts, while suited for certain specific cases, do not meet the general requirements of machine drive. An attempt to obtain the necessary speeds by gearing, for example, is not only costly (if a sufficient number of changes are provided), but inefficient in that, as a rule, the machinery must be stopped to change from one speed to another, and cannot be controlled from an independent point.

(4) For adjustable speed work, direct-current motors only give satisfactory results at the present time. It is not practical by this means to use a range greater than 6 to 1, while in the majority of cases 3 to 1 gives the most economical results. In other words, in

most instances, it is necessary to resort to a combination of mechanical and electrical control, the disadvantages of each being largely eliminated by this means. For example, even where machines are handling a very general line of work the greater part of it will be covered by a range of 3 to 1, so that if this amount is obtained electrically gear changes will be seldom necessary, and at the same time a comparatively inexpensive motor required. Consequently, the lathe requirements specified above are of quite as much value to the man who designs the mechanical features of the machine as the one who furnished the electrical apparatus.

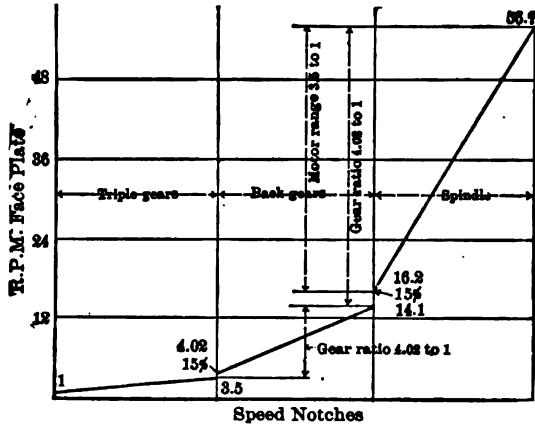

FIG. 10.—LATHE, A.-B.-COMPANY.

(5) Long transmission lines may make alternating-current desirable, and, for certain extended plants, the best results can be obtained by its use, together with motor generator for direct-current variable-speed motors. If, however, but one kind of current will be available, decision should be largely governed by number of individual drives required. In many instances, while group drives may be desirable at the start, new equipment should be purchased with individual motors for the sake of adjustable speed and ease of control.

Returning to the 60-in. lathe considered above, the total speed range of 57 to 1 can be covered by the usual triple gear arrangement, with the resulting ratios shown on the chart. The range in motor speed, of 3.5 to 1, is quite practical and can be taken care of by any one of the systems referred to above.

I will not dwell upon the strictly mechanical details of the drive, rather assuming that this part of the work is properly taken care of, but pass on to a consideration of the motor-drive systems.

(2) NOTES ON MOTOR-DRIVE SYSTEMS.

Systems now on the market for obtaining adjustable speed by means of motor drive, and advocated by prominent manufacturers, are given below :

- (1) Field weakening only.
- (2) Double commutator motor combined with field weakening.
- (3) Edison three-wire system combined with field weakening.
- (4) Unbalanced three-wire system combined with field weakening.
- (5) Four-wire multiple-voltage system combined with field weakening.

There are two classes of purchasers, with widely differing requirements, and to whom different systems appeal :

- (1) The customer who buys motors for his own use to equip machines already in operation, or where special machinery, must be given individual consideration.
- (2) The customer who buys for an unknown third party: The builder of machines, for example, who manufactures his product without any knowledge as to who the purchaser may be, and consequently must design equipments that will meet conditions existing in plants where his product is solicited.

The electrical manufacturers have been slow in realizing this almost self-evident classification. The very essence of modern manufacturing consists in specialization, as it is only in this way that cost can be reduced to a minimum. Such establishments must be classified under the second division referred to above, and the product considered as a *type*, while in the first class given machines or given establishments can be treated separately.

Conditions in the past have in either case demanded a separate consideration of drive for practically every customer, on account of special character and numerous types of motor-drive equipment, but substantial progress, as far as the machine builders are concerned, will not be made until their product is manufactured complete in every essential. This means the adoption of a motor that can be operated on 110 or 230 volts, direct current, as one of these

is not only found in nearly every large establishment, where it is used for cranes and lighting, but in many of the smallest shops.

The three and four-wire systems, on the other hand, have been installed by a very small percentage of the shops who are, from time to time, purchasing new equipments, so for commercial reasons such apparatus does not appeal to machine builders. It may, however, possess distinct advantages to purchasers of the first class who contemplate the motor equipment of an entire shop, either at once or as conditions demand. As they can exercise the greatest freedom in selection of equipment for motor drive, I will consider the systems enumerated above from their standpoint. It will then be a comparatively simple matter to apply these conclusions to the more special conditions which must be met by the machine builders.

All customers, unless they employ consulting engineers, are called upon to decide themselves upon the system to adopt, and, as their experience does not, as a rule, cover the details of electrical engineering, they must depend largely on the statements put forward by electrical companies.

There is no doubt that the manufacturers in many instances have taken advantage of the special character of machine work to rate their motors in a way that is very deceptive. The words "full load" are almost universally abused, there being no standard specification that is adhered to, so the only safe basis for comparison is through a knowledge of the weight and maximum speed for a given horse-power through a given range, with the understanding that a specified overload must be carried at any point for a certain time. Such an analysis would, according to the views of the various builders, give at least an intelligent idea of the equipment required to fill a definite need, but in a number of instances our experience has indicated that claims made by leading manufacturers have not been fulfilled in actual test. Machine-tool duty unquestionably permits of a different basis of rating from constant horse-power work in much the same way that street railway motors are rated on a basis of their own, but when one manufacturer adheres strictly to a rating of present standard, and another departs from it without the knowledge of the customer, the latter is likely to be comparing bids on two radically different equipments. This we have repeatedly found to be the case. I feel that this matter should be given careful consideration by such a body as the American Institute of Electrical Engineers and a definite understanding arrived at.

I will assume general familiarity with the systems under consideration. In general, a motor for a given maximum speed and a given range, to deliver a given horse-power through this range, will be at least as large when operated by field weakening only, as when a combination of either two or more voltages with field weakening is adopted. Unless the motor is specially designed for field weakening it will be larger than in the latter case. We have been unable to obtain any satisfactory data from the engineering departments of electrical manufacturers concerning variation of horse-power with field strength, so prefer to base our conclusions upon tests which we have conducted in connection with work for various clients.

As the cost of variable-speed motors and auxiliary power transmission equipment, such as chain or gears, is in proportion to the speed at which it operates, we should see that the latter is as high as is consistent with the various engineering considerations. A number of the manufacturers of motors do not give sufficient thought to the adaptation of motor speeds to available means of transmitting power to the machine. There are three methods in common use, namely: leather belts, gears (including worm and spiral gearing) and chain. While the great flexibility of the belt, in relieving the machine of sudden jar, has distinct advantages in certain instances, gears and chain are used in the majority of cases for individual drive.

(1) *Field Weakening (with a Single Voltage).*

A number of manufacturers have recently placed on the market motors designed to run on a single voltage, but that may be varied in speed by means of field weakening over a range, in some cases, as high as 6 to 1. Until recently, ranges as great as the above have not been considered practicable and our tests of motors of various makes have indicated that in this regard much can be accomplished through careful motor design. Manufacturers that adhere to the simple shunt type do not advocate, except for special work, a range exceeding 4 to 1, while others who have adopted either additional poles or special windings claim to have eliminated the difficulties usually encountered in this work, and are prepared to furnish motors giving any variation desired. These types, however, have not been in operation a sufficient length of time to enable us to confirm their statements.

We have found that customers are frequently misled concerning the size frame required for a given duty for motors operating on this system. As the horse-power that can be developed with a given frame is in proportion to the speed of the armature, it is necessary to use, for a range of 4 to 1, a motor frame rated at least four times as large as the power required if practical speeds are not to be exceeded. Even such a frame will not, in most cases, make it possible to rate the motor as liberally as is the case with standard constant-speed apparatus, as the exceptionally strong field required is likely to cause heating at the slow speed and at the high speed the weakened field will cause poor commutation.

We have not yet experimented with a motor of this type that

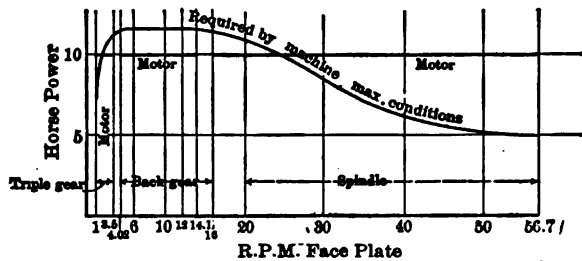

FIG. 11.— DATA RELATIVE TO SINGLE VOLTAGE MOTOR EQUIPMENT FOR LATHE OF A.-B.-COMPANY.

would operate continuously under the full-load current at its highest speed without giving some trouble at the commutator. It is true, as was stated above, that such conditions would rarely be met in the machine shop, but to purchase with intelligence it is necessary to know how fully manufacturers depend on this fact. Motors with a range of 3 to 1 have already been successfully applied to machines requiring a comparatively small amount of power, although, as will be pointed out later, the apparatus has not been perfected as fully as is the case with other systems.

If the lathe considered above be equipped with apparatus operating on this system, the relation between motor horse-power and that required by machine, shown in Fig. 11, should fulfill the conditions satisfactorily, as the upper curve is drawn through maximum values, and when they are reached the overload on the motor would only be 30 per cent.

Referring to the dimensions and ratings furnished by one of the manufacturers, whose apparatus has shown up very favorably under

test, we find that a motor weighing 1615 lbs. will deliver 10 horse-power between a range of 350 r.p.m. and 1050 r.p.m., or one weighing 2300 lbs. will deliver 10 horse-power between 225 r.p.m. and 900 r.p.m. We would recommend the use of the last frame, as satisfactory commutation should be assured by the smaller speed range, namely, 225 r.p.m. to 787 r.p.m.

(2) *Double Commutator Motor (Combined with Field Weakening).*

The additional cost of the double commutator motor, together with the maintenance of two commutators instead of one, are objections to this system that, in our estimation, offset its advantages for other than special cases.

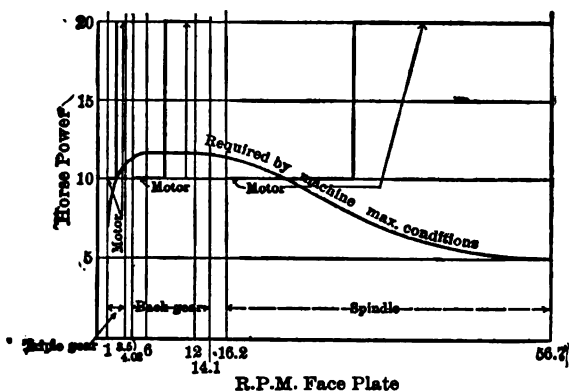

FIG. 12.— DATA RELATIVE TO EDISON THREE-WIRE MOTOR EQUIPMENT FOR LATHE, A.-B.-COMPANY.

(3) *Edison Three-Wire System.*

The combination of the Edison three-wire system with field weakening permits of a range of 4 to 1, with but 100 per cent increase in speed by the latter means, and, consequently, eliminates commutator troubles to a marked extent.

The balanced three-wire system has been adopted quite generally in the past for lighting purposes, and may be obtained either by means of standard generator, together with a separate balancer, or by providing the former with slip rings connected to an autotransformer from the middle point of which the neutral is taken. The latter arrangement is advocated by manufacturers of this apparatus.

The selection of motor to operate on three-wire system for the

60-in. lathe should be based on curves shown in Fig. 12. The same assumptions are made regarding overload as in the former case.

The motor required for these conditions, according to one of the principal advocates of the Edison three-wire system, would weigh 2600 lbs. and operate from 220 r.p.m. to 880 r.p.m.

(4) *The Unbalanced Three-Wire System.*

The unbalanced three-wire system was developed to give, with a minimum size motor, a range somewhat greater than 6 to 1. For a range of 4 to 1, or under, it has no advantage over the balanced three-wire system, nor does it possess several good features of the one last named.

(5) *Four-Wire Multiple Voltage Systems.*

The principal advantage of the multiple-voltage systems is that absolutely standard motors (the same as are used for constant-speed duty) are used with perfectly satisfactory results. This is not true of any of the other systems. Motors designed to operate on a three-wire system must run with full field full voltage at about half the speed of a constant-speed motor for the same duty, so cannot be economically used for the latter purpose. This is true to a still greater degree for motors designed to give a wide range of speed by means of field weakening only.

The maximum range in speed obtainable by the system under consideration depends upon the voltages adopted and the amount the field is weakened, but for purposes of economy except where constant torque is required, the working scale is usually confined to the higher voltages. The lower voltages while used chiefly for starting prove of great assistance at times for setting up work.

The two systems which have been advocated differ in that one requires an arithmetical series of voltages, and the other a geometrical series. In either case a balancer or specially designed generator is required to give the voltages referred to and four wires employed for distribution. These two features are frequently cited as disadvantages that more than offset the good points of this system, but, in reality, they do not complicate matters to any great extent nor add materially to the cost of a large installation.

While, as stated above, the average machine tool may be considered as requiring constant horse-power through its working range, in numerous instances, particularly when dealing with large

machinery, we find that requirements call for an increased horse-power with an increase speed. For such cases the multiple-voltage system is most desirable as is clearly shown by the curves in Fig. 13.

This data relates to a large gun lathe, driven by multiple-voltage apparatus. The lower curves are drawn through points determined by actual test and show the power required to drive the lathe with face plate in place but otherwise running light. The power available for useful work is represented by the vertical height between the curves just referred to and the upper ones, which show the relation between horse-power and speed of a standard 35-hp

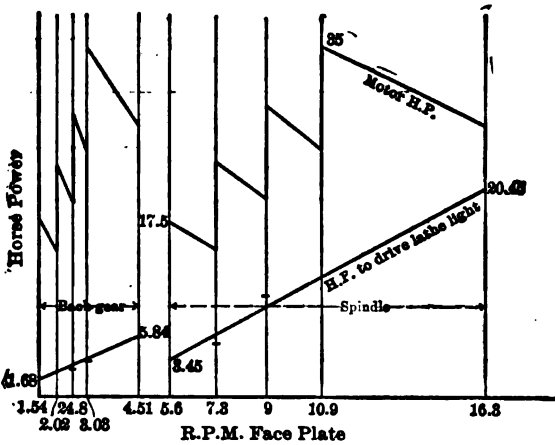

FIG. 13.— DATA RELATIVE TO MOTOR EQUIPMENT FOR LARGE GUN LATHE SHOWING ADVANTAGE OF A CONSTANT TORQUE SYSTEM.

Crocker-Wheeler motor. Such examples are, of course, exceptional.

So far I have assumed the use of the same range in motor speeds, when operating on the spindle, back gear, and triple gear and in the case of field weakening motors, or those operating on a balanced three-wire system and rated as above. There would not be any advantage in doing otherwise. The characteristics of the multiple-voltage system, however, are such that a smaller motor can frequently be used if the gear ratios are determined by the nature of the load curve. This fact was borne in mind when plotting the curves shown in Fig. 14, relative to multiple voltage equipment for lathe A.-B.-Company. A motor weighing 2350 lbs. and operating from 235

r.p.m. to 820 r.p.m. is recommended by one of the leading manufacturers of this apparatus.

They prefer to rate their motors very conservatively which accounts for the decrease in horse-power with field weakening. By actual test their motors stand up under these conditions as well as many other makes that are said to deliver constant horse-power through a range of 2 to 1.

(3) NOTES CONCERNING DIFFERENT MAKES OF APPARATUS.

In every instance final decision must rest with the perfection of apparatus. One of the most important details so far as efficient shop use of the motor drive is concerned is the controlling mechan-

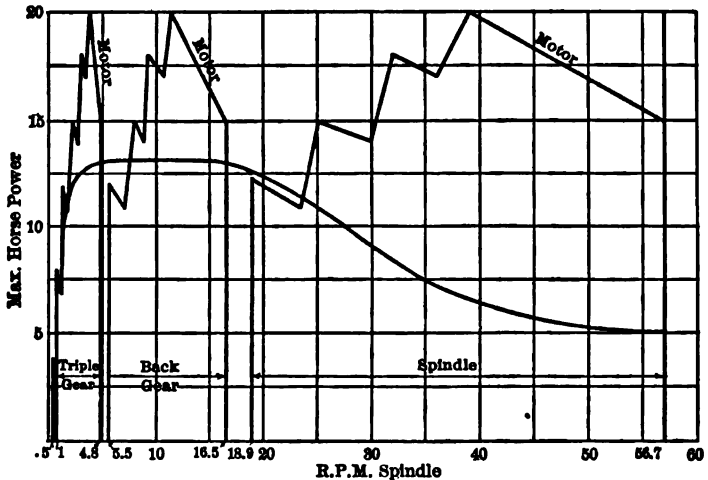

FIG. 14.— DATA RELATIVE TO FOUR-WIRE MULTIPLE VOLTAGE MOTOR EQUIPMENT FOR LATHE, A.-B.-COMPANY.

ism. For machine-shop duty thoroughly rugged and compact controllers are required. No contacts should be exposed as is now the case with the apparatus furnished by a number of manufacturers of field weakening motors. With thoroughly efficient apparatus it is practically impossible to do damage to either the motor or controller by the rapid operation of the latter. I do not mean by this that it is well to swing the controller handle suddenly from the off position to the full-speed point, but such action should not result in destructive sparking at the commutator or arcing at the controller points.

The satisfactory operation of a controller for the conditions under consideration depends largely upon the success with which the manufacturer has fulfilled the following conditions:

(1) Controllers should be completely inclosed in iron casing.

(2) It should be impossible through the manipulation of the controller to stop the motor at any place on the scale other than the off position.

(3) Rapid operation of the controller should not cause serious damage to either motor or controller.

(4) They should be so designed that they can be easily operated from a convenient point on machine.

(5) A sufficient number of speeds should be provided, depending on machine requirements.

(6) Controllers that require frequent operation must be designed with liberal contact surface and more rugged in every respect than those used principally as "speed setters," and as a result only operated at intervals.

(7) The design should permit repairs with the greatest ease. In this connection the location and type of resistance grids should be given careful consideration.

(8) Each speed should be clearly defined either by a star-wheel and pawl or other means.

A number of manufacturers have placed on the market controllers that are giving good results, and in most respects comply with the above requirements.

Motors have been designed to accompany these controllers that are well suited in so far as their external dimensions are concerned for application to machines, but at the same time we feel sure that the electrical manufacturers who are willing in certain cases to depart from present designs will gain a strong position with the machine builders.

(4) CONCLUSIONS.

In all probability a paper such as I have prepared for this meeting of electrical engineers, would have seemed decidedly out of place some years ago. I have dealt with matters which would then have been considered the business of the machine builder or mechanical engineer, and not requiring the thought and study of the electrical profession. It is now realized, however, that the motor-drive problem presents many new features, and is a distinctly different one from the manufacture and sale of standard generators for

example. The earning power of the latter is largely dependent upon the design and workmanship, features that can be passed upon before the machinery leaves the works. If a power plant is found to be too small, more units can be readily added without in any way interfering with those in use. On the other hand the earning power of a motor equipment for individual operation of machines depends largely on conditions over which the manufacturer has no control. The continued growth of this department of his plant, however, is governed by results actually obtained with his product under working conditions, so to protect himself he is called upon to see that the proper equipment is selected, and if possible, advise as to its use. As far as the customer is concerned, it would usually be better for him to close his eyes and grasp any one of possibly four makes of apparatus, devoting his time to its proper installation and operation, rather than reversing the process as is so often done.

The conclusions reached above concerning the motors required for the 60-in. lathe are summarized in the table below:

	Weight.	Min. R. P. M.	Max. R. P. M.
Field weakening	2300	225	787
Three-wire system	2600	220	770
Four-wire system	2350	235	820

It must be remembered that the ability of these motors to fill the imposed conditions was not determined by actual test—the data being the recommendation of well-known electrical companies who manufacture the respective types of apparatus. These figures should at least make it clear that many statements constantly made concerning the size motor required for a given horse-power and speed range cannot be other than erroneous.

I pointed out above the conditions which must be met by the machine builder necessitating the selection of a type of adjustable speed motor that does not require for its operation special auxiliary apparatus. While motors operating on two wires and giving a range as high as 4 to 1 by means of field weakening do not at present give as good all round results as those operating on the multiple-voltage and three-wire systems, we feel that their adoption by the manufacturers referred to is certainly justified. When this is more fully appreciated the electrical companies should rapidly achieve better results in this direction.

The customer purchasing for his own use should, on the other hand, *differentiate clearly between the machine builders' requirements and his own*, for in many cases he can secure more satisfactory results, all things considered, through the adoption of a system combining with field weakening a number of voltages.

CHAIRMAN RUSHMORE: It is unfortunate that the hour has expired which would allow discussion of the paper just read.

On motion, the Section then adjourned.

FRIDAY MORNING SESSION, SEPTEMBER 16.

The Section was called to order at 9:30 a. m., Friday, September 16, Chairman Dr. C. P. Steinmetz presiding.

CHAIRMAN STEINMETZ: The first paper on the program is on "Single-Phase Railway Motors," by Friedrich Eichberg. Since this paper has only just been received, and has not been translated, I shall give a short review thereof.

SINGLE-PHASE RAILWAY MOTORS.

BY FRIEDRICH EICHBERG.

The standard direct-current railway has probably been developed to its final stage. The combination of alternating current for the transmission of power, rotary converters for the conversion into direct-current, and direct-current car motors, is not, however, an economical solution, except in rare cases. Recognizing this fact, Brown & Boveri (Burgdorf-Thun) and Ganz & Company (Valtelina line) took up the direct application of polyphase alternating currents. But even if the polyphase system has achieved practical success in special cases, it has not been proven thereby that the polyphase motor furnishes a universal solution of the electric railway problem. It is not necessary here to repeat all the objections that European and American engineers have brought forward in numerous discussions against the polyphase motor. The multiple trolley for the collection of current, which is unavoidable in the polyphase system, leads to complications in the overhead work and sets narrow limits to the line voltage available. For short roads (lines between neighboring cities) the polyphase system, moreover, leads to excessive cost in the installation of the conducting system. Add to this that the polyphase motor, by reason of its characteristic speed-curve, which resembles that of a shunt-wound motor, is almost or quite unfit for railway purposes. It cannot be disputed that it is possible to operate on schedule time upon special lines with a favorable profile but this proves nothing as to the general applicability of the polyphase motor.

For two years, as is well known, efforts have been made to apply the single-phase motor to railway purposes. B. J. Arnold, with his electro-pneumatic system and the Oerlikon Company with the Ward-Leonard system, offered only incomplete solutions of the problem of applying single-phase current to railways. The first announcement of the direct application of single-phase motors came from Lamme, of Pittsburg, and was followed soon after by the publication of Finzi in Milan. The former used a frequency of 16, and the latter 18 cycles per second. Both have built series

motors similar to the direct-current series motor. The former uses, for the compensation of the armature reaction, short-circuited windings, which are applied in the field-magnet coils and whose axis coincides with that of the brushes; the latter uses slots in the poles for the diminution of the armature reaction.

Later the work of G. Winter (see *Elektrotechnische Zeitschrift*, 1904, No. 4), of Vienna, became known to the writer. This furnished the basis of the system worked out by the Union, and especially by the Allgemeine Elektrizitäts-Gesellschaft. This system, which forms the subject of this paper, has been put into operation on the Niederschöneweide-Spindlersfeld line under the management of the Royal Prussian State Railway, and on the Stubaital line near Innsbruck, which was opened on July 31, 1904. The first line operates with 6000 volts and 25 cycles, and the second with 2350 volts and 42 cycles.

In perfecting this single-phase system, the motor of course played the chief part. In a lesser degree the controlling apparatus and those devices which become necessary in the direct application of high tension to the car were also of importance.

In regard to the motor of the Winter-Eichberg system, it unites the properties of the ordinary alternating-current series motor with those of the repulsion motor. Its characteristic features are the following:

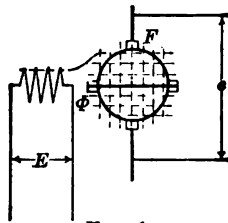
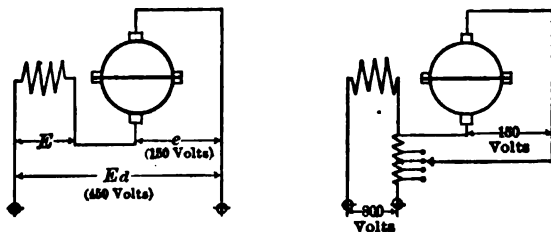

FIG. 1.

In the motor, in addition to its own magnetic field (F), there is developed as in the repulsion motor, a cross-field, ϕ which, at synchronism, is about as strong as the magnetic field F , from which it differs in phase by 90 deg. This means that when the motor is near synchronism a complete rotary field is established, the field being less developed below or above synchronous speeds. On account of the cross-field developed in the motor, the short-circuited e.m.f. under the brushes diminishes with increasing speed, becomes nearly zero at synchronism and then increases again with increasing speed.

In regard to armature voltage, these motors are essentially similar to the ordinary series motor. In both the tension per commutator segment may not exceed a certain value and, according to the size of the motor, the armature voltage will therefore lie between 100 and 200 volts. In the ordinary series-motor, in which the working voltage appears in the armature, the working voltage would therefore not exceed 200 volts. It is otherwise with our motor. Since the armature is short-circuited along the working axis and the working voltage appears only in the stator field windings, the voltage supplied to the motor may be as great as desired. But even for the case where the excitation is inserted in series with the stator winding (Fig. 2), the entire working voltage (E) is in the same proportion to the armature voltage (e) at rest as the entire volt-ampere input is to the volt-amperes for magnetization at rest.



FIGS. 2 AND 3.

Let us suppose that the magnetizing current is one-third of the armature current, which is a good practical mean; then the working voltage in the motor of our system, even with the direct introduction of the excitation, is three times as high as in the ordinary series motor. Through the insertion of a small transformer (Fig. 3) one can increase at will the proportion of the working voltage to the armature voltage without great expense (Figs. 2 and 3).

The excitation by means of the armature in combination with the cross-field yields an e.m.f. which is 90 deg. ahead of the working e.m.f. and directly opposite to the e.m.f. of self-induction. This wattless counter e.m.f. gives the motor the well-known rapidly rising $\cos \phi$ curve. (See *Elektrotechnische Zeitschrift*, 1904, No. 4.) Our first 100-hp motor had, with a 3-mm air-space on each side, a power factor of 0.9 even at 70 per cent of synchronism. Even more important is the fact that this good power factor is obtained with a number of ampere-turns per cm almost twice as

great as in the ordinary alternating-current motors. From this results the possibility of building a very powerful motor for a given armature diameter and external dimensions.

Another characteristic property of our system is that the field can be controlled independently of the voltage in the working windings. In every alternating-current commutator motor there are magnetic losses in the coils short-circuited by the brushes. Through the possibility of adjusting this field in proportion to the stator current, one can keep these losses under the brushes within such limits as will permit the commutator and the brush-holders easily to conduct away the resulting heat. By varying the field one can, for a given working voltage, give the motor a variable characteristic. The separate characteristic curves will then be somewhat related as the curves of a 3-, 4-, 5- and 6-winding motor. Control independent of this naturally is possible and also control of the load voltage. The accompanying diagrams give examples of the control as carried out in practical cases. In Fig. 4 the primary voltage is not regulated and only the secondary winding of the exciting transformer is altered.

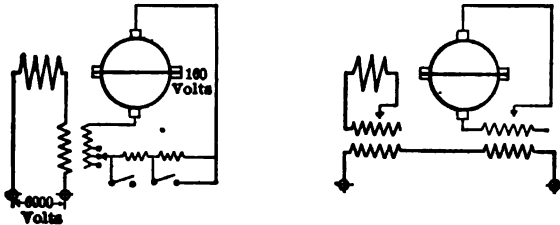

FIGS. 4 AND 5.

The absence of any primary regulation in the high-tension circuit offers the special advantage that only low-tension circuits will have to be opened or closed when the car is to start, reverse or alter its speed. A still more complete solution is shown in Fig. 5, the stator circuit as well as the exciter circuit being regulated. This method of connection is less advantageously applied to high-tension motors, because the high-tension circuits generally can not be readily altered in operation.

The third diagram (Figs. 6a and 6b) shows a method of control which, although not quite so complete as that of Fig. 5, is yet of value for small low-tension cars, and which will shortly be put into operation on a short Belgian road. The scheme of

Fig. 5, with the modification represented in Fig. 7, was installed on the Stubaital line near Innsbruck, now in operation, which is at times operated at 2350 volts and at other times at 400 volts. The direct insertion of the excitation in the stator circuit (Fig. 2) in which the control is effected by ohmic or inductive resistances

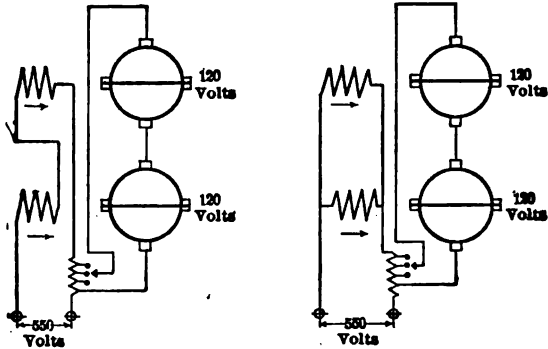

FIGS. 6A AND 6B.

with the eventual application of series-parallel regulation, is possible for small cars, and hence chiefly applicable to short railway lines. In the latter case the motors can be built simply for 550 volts. Motors for 550 volts connected in this manner are already in operation, and will also run on direct-current lines. (Figs. 7a and 7b.)

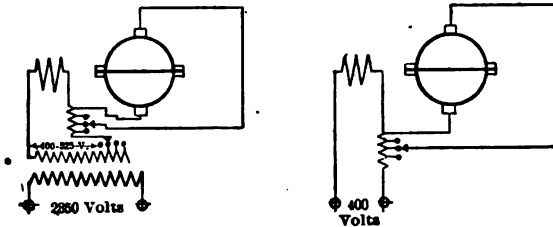

FIGS. 7A AND 7B.

The possibility of running an alternating-current motor with direct current is of great importance in practical application. Ordinary series commutator motors, which are built on the compensated system of Deri, can of course be run both on direct-current and alternating-current circuits. The voltage for the direct-current motor is $1\frac{1}{2}$ to 2 times higher than the armature

voltage with alternating current. Since, as we have shown above, the alternating-current voltage, which in our motor system can be directly applied, may be three times greater than the armature voltage, the ratio of direct-current to alternating-current voltage will be, not as in the series motor 3:1½ or 3:2, but 3:3 to 1½ or 2; that is, the direct-current voltage will be about half that of the alternating-current voltage. This allows, for example, the running with direct currents with motors connected in series, and with alternating current with the motors connected in parallel, but in the former case at less speed. This corresponds to the case in common practice where cars which travel over interurban stretches at high speed transfer to the direct-current systems of cities, where lower speed is demanded. There are various ways of running, with a motor connected according to Fig. 1, on direct-current circuits. The method which has proved itself most practical is represented in Fig. 8. In the direction of the diameter of the exciter axis a winding is applied which counteracts and opposes the armature ampere-turns. The stator field windings then produce a magnetic field with direct current, and the exciting windings on the armature represent with direct current the working ampere windings. The field saturation in direct current working is then somewhat greater than with alternating current, while the density in the armature is somewhat less. These properties are extraordinarily favorable for practical operation. The auxiliary winding (h) is inserted only when operating with direct current. In order to make better use of the armature, the field windings of two motors can be connected in parallel in the direct-current circuit, while in order to be able to operate at 500-550 volts with direct currents, the armatures can be connected in series. These conditions are represented in Fig. 9. In the alternating-current system, one can operate according to the method of either Fig. 3 or Fig. 6. If operated according to plan 3, then with alternating currents the connections 2, 4, 5 are closed and 1 and 3 are open. With direct current, 1 and 3 are closed, and 2, 4 and 5 are open.

The motor system which I have above briefly described will not be the only one in the field. I can not, however, undertake to pass an unbiased opinion upon the different systems possible. I can only briefly mention the reasons why, in my opinion, the alternating-current commutator motor, which has been long known in two general types, namely, the ordinary series motor and the

repulsion motor, is not to be considered of equal value to the system above described. The ordinary series motor possesses, even if it is compensated, no cross-field; and it has no rotary field. The short-circuit losses under the brushes do not decrease with increasing speed, and the power-factor increases much slower with the speed. The maximum working voltage for which it can be built is 200 volts. When a short circuit takes place in the field winding of the series motor, the motor becomes inoperative. Multipolar machines with series windings on the armature, if provided with the device shown in Fig. 1, can have an entire field coil short-circuited without the motor becoming inoperative. The separate field coils behave like transformers inserted in series. Any one of these can always be short-circuited; the others then receive correspondingly more voltage.

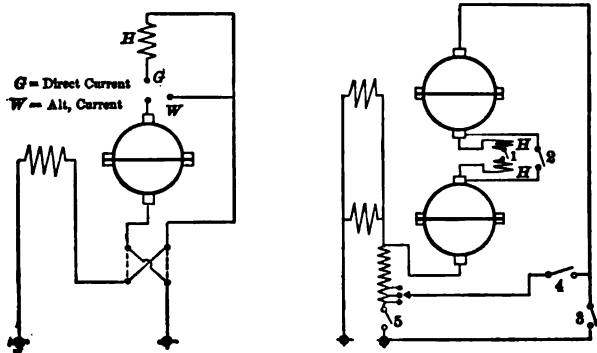

FIGS. 8 AND 9.

The repulsion motor when contrasted with the arrangement of Fig. 1 has the disadvantage that its reversal is possible only by the application of a second field-winding, or of several sets of brushes, or of reversible brushes. Its power-factor is poorer, and for its control there remains only either the method of primary voltage control, the opening of short circuits, or finally of brush reversal.

The disadvantage of the type represented in Fig. 1, as compared with the series and repulsion motor, consists in the employment of two exciter brushes, which doubles the number of brushes in multipolar systems. These exciter brushes give rise to no difficulties with respect to short-circuit losses; as I have shown (*Elektrische Bahnen*, Vol. 2, 1904), these short-circuit losses do not occur with exciter brushes. They carry moreover only one-

third to one-fourth of the entire short-circuit current. On the other hand, the motor of Fig. 1, as compared with the compensated series motor and the repulsion motor with the double field-winding, offers the constructional advantage of only one field phase, which guarantees good economy and great simplicity. In high-tension motors, the increased certainty of operation in consequence of the absence of cross windings must be considered. Motors for either direct-current or alternating-current working provided with the auxiliary winding (h), which plays the part of the compensation winding of the compensated series motor, can therefore only be operated advantageously with low-tension alternating currents.

The results of more than a year's operation on the 6000-volt Niederschönevide-Spindlersfeld line, on which during a great part of the day four 100-hp motors haul a 160- to 170-ton train, and on which daily two motors handle a 100-ton train, prove that the alternating-current motor is adapted to the heaviest traffic. Moreover, the direct application of 6000 volts to the car has been demonstrated to be entirely safe.

The Stubaital line, which has been running since July 31, 1904, at 42 cycles and 2350 volts, has introduced an advanced practice for small roads, an advance which exceeds the boldest expectations of the year 1902. At that time it seemed as though only very low frequencies could be used. In the case of many roads running in connection with existing power stations operating with 40-50 cycles, the possibility of using these frequencies limits the availability of alternating-current traction. Moreover, the possibility of operating also with direct current makes the alternating-current commutator motor in a certain sense a universal motor, and places it, as regards its main features, far above the direct-current commutator motor, which really represents only a special case of the alternating-current commutator motor.

DISCUSSION.

CHAIRMAN STEINMETZ: The discussion of this paper is now in order. Since this paper belongs essentially in the series on alternating-current railway motor, which was discussed in a previous joint session, and on which discussion will be continued in Section F later on in the forenoon, I believe we can proceed to the next paper, which is by Prof. André Blondel. I will call upon Mr. Slichter to abstract the paper.

METHODS OF TESTING ALTERNATORS ACCORDING TO THE THEORY OF TWO REACTIONS.

BY PROF. ANDRÉ BLONDEL, *École des Ponts et Chaussées.*

The author described in the *Bulletin de la Société des Electriciens* in 1892 a method of testing alternators similar to that of Hopkinson for direct-current machines, which permits of studying both their efficiency and their armature reactions, under the same conditions of operation and without a large expenditure of power, under the sole condition that the two alternators shall be similar. This method depends upon the rigid coupling of two similar alternators. Later the author published a variation of the method which does not call for the rigid coupling between the alternators, but which consists in operating the alternator on test as a synchronous motor, by the aid of an auxiliary alternator.¹ The alternator under test revolves on no-load, as a motor, under the normal current. This method has been designed particularly to determine the efficiency with greater precision than by separating the various losses. The object of the present paper is to complete and yet further perfect this method by pointing out how it may be likewise used for measuring armature-reactions (especially by the employment of two reactions, set forth in another communication of the author).

Method No. 1. When the rigid coupling of the two alternators is possible.—When two similar alternators are available, and when they can be placed side by side so as to be connected rigidly by a short coupling, the following tests may be carried out (Fig. 1):

First a certain difference of phase α is provided between the alternators (for example, a phase-difference of 30 deg., that is to say, one-sixth of a pole; or 45 deg., that is to say, one-fourth of a pole, or one-eighth of a complete pitch). The system of two machines is driven by a measuring motor whose duty it is to furnish the power necessary for satisfying the losses. Between the

1. See *La Lumière Électrique*, 1893.

two alternators A_1, A_2 (Fig. 1) whose terminals are connected each to each by very short couplings of negligible impedance, a voltmeter V is connected across, an ammeter A and a wattmeter W

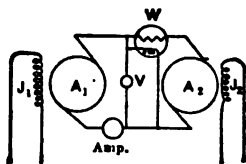

FIG. 1.

being inserted in series. The figure is drawn upon the supposition of two single-phase machines, but applies equally well to the case of two similar three-phase machines coupled by their three phases, testing upon a single phase, taking care that the phases remain balanced, in spite of the measuring instruments.

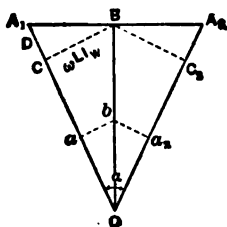

FIG. 2.

Let $U = OB$ (Fig. 2) be the difference of potential observed at the common terminals OA_1 and OA_2 , the directions of the vector e.m.f.s. dephased relatively to each other by the angle α . By symmetry, the vector Ob which represents the current will also be directed along OB , and the line A_1A_2 , drawn from B perpendicularly to U and I will represent the double transverse reaction $2 \omega L' I$. There will be a flow of current between the alternators without the production of any external power. The current will be in phase with the e.m.f. at the terminals U , as if the alternators supplied a conducting system devoid of inductance; the flux density obtained in the armature will be the same in both alternators, since it gives rise to the same e.m.f. at the terminals

U . The power furnished by each will be measured by the watt-meter W , and the total loss p will be furnished by the method of double-weighing, by means of the measuring motor which drives both alternators. The efficiency will then be the ratio

$$P_e = \frac{UI}{UI + \frac{p}{2}}$$

To determine the excitations necessary for the two alternators to produce the condition above described, it is sufficient to apply the graphic method of two reactions, as follows (Fig. 2): from the point B a perpendicular BC is let fall upon the straight line OA_1 , and the condition is such as if the alternator were delivering power to an inductive system by means of the total characteristic of excitation (Fig. 3). The current I is formed of two compo-

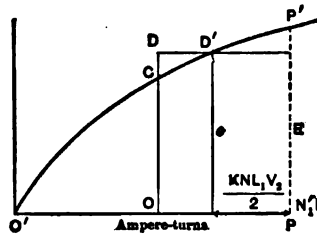

FIG. 3.

nents: one a watt component Oa , equal to the projection of I upon OA , and which gives the transverse reaction BC equal to $\omega L I_w$; the other component is a wattless component ab , which gives the fall of potential to be calculated on the characteristic. Let us lay off on this characteristic (Fig. 3) an ordinate equal to OC , and upon the latter a segment CD equal to the e.m.f. lost by the stray field. From the point D lay off horizontally the counter ampere-turns, equal to the counter ampere-turns of the armature, and thus will be obtained on the abscissa $O'P$ the total ampere-turns necessary for the excitation. The ordinate PP' corresponding thereto will represent the e.m.f. E on open circuit necessary for alternator A_1 , and which will be, in general, different from the length of OA_1 , which was represented in Fig. 2.

In the same way the e.m.f. is determined which is necessary for the alternator OA_2 , observing that for the latter the sign of

the wattless armature-reaction is changed, as well as the sign of $E = A_1 O$, and that, consequently, the armature-reaction remains demagnetizing, so that the geometrical construction is identical. It is, therefore, easy to recognize in advance the equal excitations to be given to the two alternators, in order to satisfy the desired conditions. It should also be determined at the time of the test, by means of the wattmeter, that there is no sensible difference of phase between the current and the e.m.f. Inversely, if this condition were directly realized by adjusting the excitations, it would be possible to deduce from an examination of the diagram the total armature reactions represented by the abscissa OP , indicating the *total* fall of excitation between the open-circuit e.m.f. and the e.m.f. under load. In the latter case, the fall due to the stray field is not separated from that due to armature reaction.

The same diagram gives immediately the value of the transverse reaction, since the angle α is known experimentally, and the values of U and I can be consequently measured. This gives

$$A_1 B = \omega L'I = U \tan \frac{\alpha}{2}$$

from which L' is known as a function of α , U and I .

The same method permits varying the angle α successively, and repeating the operation, commencing each time with the same voltage at the terminals U , and thus tracing the entire characteristic of an alternator operating upon a dead resistance.

The above method gives immediately the values of the direct and transverse armature reactions. As to the coefficient of self-induction of the stray field $\omega \kappa$, it may be determined for any given alternator by the method indicated later on.

A test may then be made of the two alternators coupled together, without any angular difference of phase between them. The e.m.fs. $E_1 E_2$ are then in simple opposition of phase, and the difference $E_1 - E_2$ will produce a resultant current which may be regulated in strength by regulating the difference of excitation, and which current is dephased by nearly 90 deg. The diagram is given in Fig. 4, where OC_1 and OC_2 are the two internal e.m.fs. The difference $C_1 C_2$ represents the fall of potential due to the impedance of the circuit of the armatures, and which can be decomposed into two rectangular straight lines, $C_1 F$ representing the total ohmic drop $(R_1 + R_2) I$ due to the current, and $C_2 F$ the

total reactive drop in the armatures. Projecting F upon $C_1 C_2$, a vector $C_2 F'$ is obtained, which differs but little from $C_2 C_1$, and which represents the fall of potential of the two machines due to direct reaction. If the characteristic total excitation be

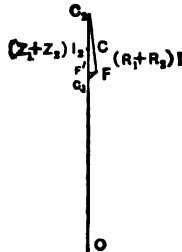

FIG. 4.

then drawn as in Fig. 5, this drop will represent the sum of the two drops due to the wattless current, of which one CC_1 is positive and the other CC_2 is negative. It is easy to mark these off on the characteristic. Inversely, the drops due to the wattless current about the point C may be deduced, and thus the coefficient K of direct reaction. It is sufficient, starting from the point C ,

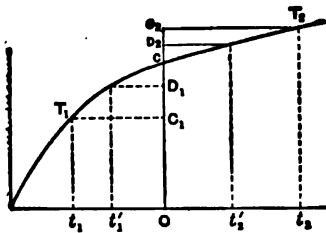

FIG. 5.

to trace two segments CC_1 , CC_2 , representing the two drops, and to trace the horizontals $C_1 T_1$, $C_2 T_2$; thence the abscissas $O t_1$, $O t_2$, which represent the virtually lost ampere-turns. If the segments CD_1 , CD_2 are known, which represent the e.m.f.s. of dispersion, and if the horizontal straight lines are drawn through D_1 and D_2 , the corresponding abscissas t'_1 and t'_2 permit of calculating exactly the back ampere-turns, $t_1 t'_1$, $t_2 t'_2$ represented by the armature, and which should have equal magnitudes.

Method No. 2. Applicable to a simple synchronous machine operating upon an actual conducting system.—When only one alternator is available for the test, it is not possible to proceed so conveniently as in the last case, and, in particular, the plan of testing with variable angles of coupling must be given up.

A similar test to that which we have indicated above can, however, be made by driving the alternator on open circuit as a synchronous motor supplied from the conducting system on which it is to be employed (supposing the factory to have other alter-

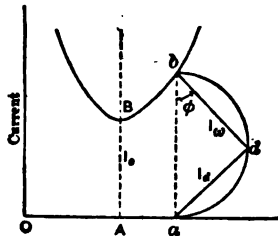

FIG. 6.

nators already installed) or by a current furnished from some other alternator of equivalent power. The alternator, or alternators, serving as the source, will then be excited in such a manner as always to maintain the voltage constant at the terminals of the alternator under test which operates as a synchronous motor, this voltage being the normal voltage of operation, the excitation of the motor is to be varied as if it were desired to obtain the "V curve" of constant voltage. The latter gives by its minimum ordinate AB (Fig. 6) the value of the ohmic losses (at current I_0), and the indication of the condition of excitation OA corresponding to a power-factor equal to unity ($\cos \varphi = 1$)—at least on the hypothesis that the effects of harmonics in the e.m.f. are inconsiderable. For any other excitation Oa , the strength of the wattless current may be obtained by constructing upon ab a triangle of which the angle at b is given by the wattmeter (the side $bd = I_w$, which differs little from BA , that is to say, from the watt-current on open circuit). ad then represents the wattless current I_a . The value of the wattless current delivered or received by the motor may then be deduced from the V curve for all values of excitation. If reference is made to the characteristic in Fig. 7, on which OC represents the normal e.m.f.

at the terminals, the knowledge of Aa gives for each value of the current I_a the corresponding value of the total lost ampere-turns $OF = Aa$. A curve of these ampere-turns may then be drawn up as a function of I_a , and the total fall of potential CD thus deduced from the chart for every value of the armature current.

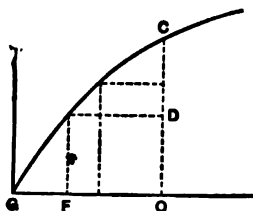

FIG. 7.

This method does not separate the reaction into two parts according to theory, but it gives exactly the required result which makes it possible to calculate the fall of potential for each value of the current and of the phase with respect to the mean e.m.f. CD which the armature is designed to supply.

To complete this indication, it suffices to know the transverse reaction. This may be determined readily enough in the same test, if care is taken to measure the phase of the angle φ of the current with respect to the e.m.f. at the terminals U . Let us trace in fact (Fig. 8) the voltage diagram of the synchronous

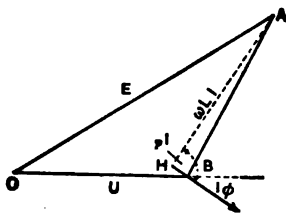

FIG. 8.

motor, OA representing the internal e.m.f. E , OB the pressure at its terminals U , the geometric difference AB the fall of potential due to impedance, which may be decomposed into two factors— BH as representing the ohmic drop of potential, HA representing the drop of potential $\omega L'I$ calculated as a function of the transverse reaction. A knowledge of the angle φ and of

the strength of the current I permits of determining the point H and thus the direction HA . Knowing the e.m.f. E (which is no other than the e.m.f. on open circuit corresponding to the same excitation of the alternator), it is sufficient to describe a circle with E as radius and to take its point of intersection with the direction HA in order to obtain the point A and to complete consequently the construction of the triangle OAH . The length AH gives immediately the value of the transverse self-induction L' . The same determination may then be recommenced with the successive increasing values of φ as the excitation is increased; the larger the angle φ becomes the more definitely satisfactory becomes the determination of L' .

Instead of evaluating in the preceding test the watt current I_w , in order to deduce the wattless current I_a , it would be easy, if a measuring motor were at hand, to make this deliver directly to the shaft of the alternator operating as a synchronous motor, the necessary power for driving the motor, in such a manner that AB on the V curve (Fig. 6) becomes nil. But the same result may be obtained yet more easily when a steam alternator unit has to be tested, by admitting to the engine just enough steam to satisfy the losses both of the engine and alternator, so that the alternator only receives a wattless current. With this object, the steam admission may be regulated in such a manner that the alternator, excited so as to give on open circuit the normal e.m.f. U of the system, runs idly in synchronism; then no change is made either in steam admission or in the pressure, and the operations are conducted entirely on the electric side of the alternator, connecting this with the system and varying its excitation so as to develop the V curve. It is possible to measure in advance the electric power necessary to drive the alternator and its steam engine on open circuit, and thus to deduce the total losses on open circuit. The power wasted may thus be measured by the steam-engine indicator-diagram, which permits of determining the constant of the curve of steam consumption as a function of the power produced (a curve which generally is nearly a simple straight line); it is also possible to separate the mechanical losses, first making this test without field-excitation, and then exciting the field-magnets so as to obtain the normal e.m.f.²

3. The total efficiency of the engine and alternator unit may also be obtained later at load by means of the engine diagrams.

Summing up, this test permits of determining, with a fair approximation, the losses on open circuit and then on load, without being obliged to actually develop these losses by full-load in the alternator as well as the corresponding heatings.

From an electrical point of view the same test permits of determining the total values of the direct reaction as a function of the wattless current, and the constant L' of the transverse reaction. If it is desired to analyze these phenomena more completely, the value of ωs may be determined as follows:

Determination of ωs .—For this purpose the following considerations are made use of (the basis of which is the method of calculation of the short-circuit current given by Kapp, which does not lend itself to experimental verification):

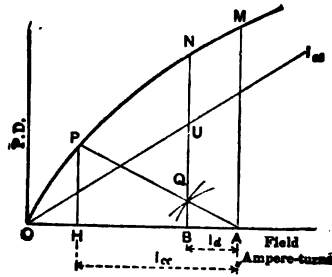

Fig. 9.

Let ONM be the characteristic of excitation; that is to say, the curve of the armature e.m.f. as a function of the exciting ampere-turns. Suppose the excitation to be constant and equal to OA ampere-turns, giving an e.m.f. represented by AM . Suppose the inductance ωs sought for to be known and also the short-circuit current I_∞ . If a point P is taken on the curve whose ordinate is equal to $\omega s I_\infty$, the corresponding segment of the abscissa AH will measure the back ampere-turns of the armature $KN I_\infty$. If the calculated values of ωs and of K are taken, the direction of the straight line AP is known, and the line may be traced from which the value of I_∞ may be deduced. This is the construction of Kapp. We shall take up, on the contrary, the inverse problem, supposing I_∞ determined by experiment and seeking to deduce from it the two constants K and ωs .

The following observation may then be made. If the segment AH be taken as the measure of the short-circuit current I_{∞} and a segment AB as the measure of any other wattless current I_a to the same scale of volts at the terminals corresponding to this wattless delivery, this segment will be equal to the ordinate $qN = U$, taken between the curve and the straight line AP . In fact, the back ampere-turns will then be equal to AH , and the loss of voltage by dispersion equal to Bq , by reason of similar triangles. Besides, the point q divides the straight line AP in the ratio of the current I_a to the short-circuit current I_{∞} .

Thus arranged, suppose that any wattless current I_a be taken experimentally at the corresponding e.m.f. U ; the point q will be determined by these two conditions: its vertical distance from the curve of excitation is equal to U and its radial distance from the point A is equal to $\frac{I_a}{I_{\infty}} \times AP$.

The point is found, therefore, at the intersection of two new curves that are easily drawn: a curve parallel to ONM traced at a vertical distance U below the former, and a curve homothetic to the curve of excitation with respect to the point A , with homothetic ratio $\frac{I_a}{I_{\infty}}$. These two curves are parallel in their rectangular parts, and separate as much one from the other as the point M is selected further beyond the bend in the characteristic. They would coincide if the point M were below the bend. The experiment should therefore be made with an excitation OA sufficient clearly to pass the bend.

The test is made by causing the alternator to operate first on short-circuit, and then upon a reactance-coil having an open magnetic circuit, or upon an under-excited synchronous motor, giving $\cos \varphi$ less 0.20, that is to say, a current almost entirely wattless.

It is understood that if not only one, but also several, wattless circuits are tried, the straight line OQ will be still better determined thereby, and consequently ωs will be known with correspondingly greater precision.

Analogies between this method and that of Potier-Behrend.—

It is possible also to follow a somewhat different course, by causing the alternator under test to operate upon an inductive circuit with $\cos \varphi$ nearly 0 (for example, upon a synchronous motor driven by a motor adjusted in a manner to produce just the power

consumed at light load), and by varying the excitation of the alternator; in this manner a *constant wattless-current* curve is obtained, from which may be deduced, by the method of M. Potier, the coefficient of the back ampere-turns, and the coefficient of the stray field, but which is not directly applicable to the ordinary problem of the calculation of the ampere-turns necessary for constant voltage.

This method is one of those which was devised by Mr. B. A. Behrend, who recently published a number of applications of it. It is wholly different from the preceding in which the voltage is maintained constant at the terminals instead of the current. The same author employs also another method which consists in dividing the field magnets into two equal parts to which are given exciting currents of opposite sign and slightly different strength, so as to develop in the armature a certain current, which is necessarily wattless, while developing a mean flux-density sensibly equal to that in normal operation. This test may appear equiva-

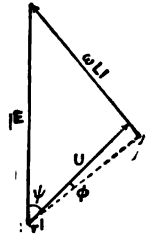

FIG. 10.

lent to that which is obtained by means of two alternators mechanically coupled and set at opposite phase (see preceding Method No. 1), with the simplification, however, that only one alternator is employed; but as the current thus obtained is only a wattless current, the conditions are not identical with those of the preceding method but only equivalent to Method No. 2 above described (see the case of the alternator operating as a synchronous motor on no-load). It is not, besides, sufficiently rigorous except for alternators having a large number of poles, because when there are but few poles the presence of two poles of the same sign side by side upon the field magnet at two points on the latter would seem to modify notably the conditions of the magnetic circuit. Consequently, Method No. 1 is preferable when it can be employed.

*Method No. 3. For the determination of transverse reaction (coefficient L).—*Besides the preceding methods, several others may also be pointed out which are very simple for the determination of the transverse reaction, and which avoid the objection so often made to the diagram in which this reaction appears. Moreover, the oscillograph (or ondograph) permits the real angle of dephasing Ψ to be measured between the internal force E (Fig. 10) and the current, and gives immediately, in consequence, the value of L , when the alternator operates upon a noninductive resistance $\varphi = 0$, by the equation

$$\tan \Psi = \frac{\omega LI + U \sin \varphi}{rI + U \cos \varphi} = \frac{\omega L}{r + \frac{U}{I}}$$

from which

$$\omega L = \left(r + \frac{U}{I} \right) \tan \Psi.$$

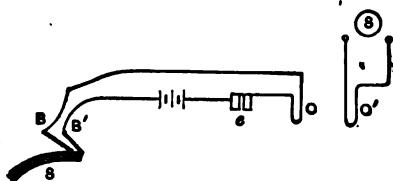

FIG. 11.

With the oscillograph, for example, it suffices to place upon the shaft, or upon one of the pole pieces of the rotating field-magnet, a contact segment S upon which rub two brushes BB' , connected in series with a battery, one of the oscillographs O of a double-oscillograph apparatus, and the electromagnet e which controls the release of the shutter. The contact segment S , insulated from the base, closes the circuit upon its passage below the brushes, and opens it again at the precise moment when the brush B leaves it. A segment is selected large enough in order that the shutter shall have time to open before the rupture of the circuit, in order that the latter may then be photographed upon the plate in the form of a vertical line intersecting the straight-line zero furnished by one of the oscillographs. The second oscillograph of the system, O' , is connected to the terminals of the alternator and serves to register the e.m.f. U at the terminals. Two experi-

ments are made on two different plates, or upon the same plate after having slightly displaced the zero-line produced by the oscillograph *O*, so as to distinguish the two different records. The e.m.f. at open circuit is then marked upon it, and next the e.m.f. when the circuit is closed upon a dead resistance, at the same time that the current *I* delivered thereto is measured. In these two tests the distance is measured from the zero of the curve of e.m.f. to the point of intersection by the vertical with the zero-line. The difference between these two lengths thus measured determines the displacement of phase of the e.m.f. at the terminals, that is to say, the angle of dephasing sought (taking for the value of 2π the length of a period measured upon the plate, and taking the ratio of the measured retardation to this length). It is sufficient to take the values of ψ of *I*, and of *U* in the preceding formula in order to determine the transverse reaction *L*.

Figs. 13, 14, 15 and 16 represent an example of the determination of *L* made by this method in the laboratory of the Société Sautter-Harlé & Company of Paris, which employs with success the methods described in this note. The curves of the first three figures have been obtained by means of the author's oscillograph at the terminals of an alternator of 350 kw, and represent the periodic curves of the difference of potential between these terminals when the alternator works on open circuit, then when delivering 62 amperes, and finally 102 amperes, its normal load. The effective value of the e.m.f. was 1155 volts in star. The vertical lines represent the tracings produced by the contact of the contact-maker *S*. Figs. 13 and 15 are printed upon one and the same sheet of paper, by causing the vertical lines to coincide, from which Fig. 16 is produced, which shows clearly in evidence the dephasing between the internal e.m.f. *E*, and the pressure at terminals *E*. The dephasing reaches 24 deg. 30 min. in the test with 102 amperes, and 19 deg. in the test with 62 amperes. In applying the preceding formula (with $r = 2.5$ ohms) the values are obtained—

$$\omega L = (2.5 \times 62 + 1155) \times 0.344 = 7.26 \text{ ohms,}$$

$$\omega L = (2.5 \times 102 + 1155) \times 0.566 = 7.81 \text{ ohms,}$$

which differ little (and would be perhaps equal if greater precision had been taken in the measurement of the phase-difference between the two curves). In practice one would take the mean value 7.5 ohms.

It is evident that it is easy thus to determine the constant of distortion, and this justifies the employment of the theory of the two reactions rather than the rough method of the "curve of short-circuit," which compounds together the two often very different reactions.

The ondograph gives the same result, if one marks off successively upon the same sheet of paper the e.m.f. upon open circuit and then that on closed circuit, and each time the mark obtained when the apparatus is traversed by the current coming from the brushes BB' . It is possible to dispense with making this mark, if the ondograph is driven, not by a synchronous motor, but by a flexible coupling connected mechanically to the shaft of the alternator (with the interposition of gear wheels, as in the recording mechanism of Francke).

Moreover, even in the absence of the preceding analyzing apparatus, one can approximately obtain the transverse reaction, or rather its ratio to the direct reaction, with unsaturated field-magnets, by sending, as M. Herdt has already suggested, into the

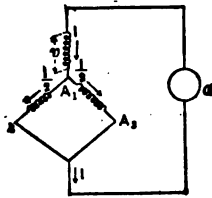

FIG. 12.

alternator armature at rest, alternating currents derived from any available external source, and measuring the apparent self-induction, by the method of Joubert, for the two characteristic positions of the field-magnet poles. The simplest method applicable to a star-wound alternator consists of sending an alternating current I through one of the phases which divides between the two other phases, starting at the neutral point, and which is received at its emergence by a connection applied to the two terminals A_2, A_3 . Fig. 12 represents the connections: a is an auxiliary alternator of which the excitation is adjusted at will in order to vary the current I . It is easy to see that an alternator thus traversed by a current is placed in the same conditions as if it were fed by

three-phase currents at the moment when one of these currents passed through its maximum. This connection being made, the field magnet is arranged so that the armature poles have their axes directed in a line with those of the field-magnet poles, and then in such a manner that these axes are directed midway between the field-magnet poles. In each case the self-induction developed by the current I is measured according to the method of Joubert; the ratio of the two measures is that of the direct self-induction to the transverse self-induction, or of the coefficients K and K' applicable to these two reactions. If the difference of potential u is measured between A and the center of the star O , the ratio $\frac{u}{I}$ represents the impedance of one phase. From this the inductance may be determined, since the resistance of one phase is known. This measure made in the second position indicated above gives, therefore, the precise and approximate value of the transverse inductance sought. It must be remembered that this inductance also comprises the inductance of dispersion; it therefore has the value

$$\omega L = \omega \lambda + \omega s$$

calling $\omega \lambda$ the transverse reaction properly so-called, not including the dispersion ωs .

Repeating the experiment for various values of the current, the constancy or the variability of the coefficient L may be determined.

DISCUSSION.

Mr. W. I. SLIGHTER: The author has two papers on this subject. The second supplements the first one and gives methods of testing alternators to obtain various constants and characteristics to be used in the calculation just explained.

The second paper by Prof. Blondel was then read, as follows:

METHODS OF CALCULATION OF THE ARMATURE REACTIONS (DIRECT AND TRANSVERSE) OF ALTERNATORS.

BY PROF. ANDRÉ BLONDEL, *École des Ponts et Chaussées.*

The author here proposes to explain and complete the theory of "two armature reactions," which was enunciated by him several years ago,¹ and which has recently been adopted, with slight modifications, by M. Rey,² M. R. V. Picou,³ and M. Guilbert⁴ in France; Professor Arnold⁵ in Germany; and Mr. Herdt⁶ and Messrs. Hobart and Punga⁷ in the United States. The notable authority of all these authors in the matter of dynamo-machine construction has made me read their communications with great interest, and as I have observed that in certain cases my own view has not been well understood, I consider it desirable to present certain supplementary considerations to make this theory still more simple to complete it finally. At the outset it should be pointed out that my diagram should not be considered as belonging to the category of e.m.fs. but rather to that of ampere-turn diagrams. The two classes are often equivalent, because if one commences with e.m.fs., one proceeds with fluxes, and ends necessarily with ampere-turns. But I desire to reduce to a minimum the complication of considerations relative to the saturation of field magnets, of which I fear the difficulties have been needlessly exaggerated.

1. "On the Empirical Theory of Alternators," *L'Industrie Electrique*, Nov. 10 and 25, 1899. This is the first publication in which the reaction in alternators was analysed, and possesses undisputable priority over all those which are mentioned below on the subject of the two reactions.

2. M. Rey. *Rapports*, International Congress of Electricians, 1900.

3. M. R. V. Picou. *Bulletin de la Société Internationale des Electriciens*, July, 1902.

4. C. F. Guilbert. *Eclairage Electrique*, March 7 and 14 and April, 1903, and *La Revue Technique*, June, 1903.

5. E. Arnold. *Elek. Zeit.*, 1902, page 250. Arnold, as pointed out farther on, has reduced the generality of the method, in contradistinction to the other authors mentioned.

6. L. A. Herdt. *Trans. Amer. Inst. El. Eng.*, May, 1902, and *Eclairage Electrique*, February 14, 1903.

7. Hobart and Punga. *Trans. Amer. Inst. El. Eng.*, April 22, 1904.

In what follows I will refer first, very briefly, to the essential points of my method of 1899, and I will show in what points it has been improved, or is susceptible of improvement.

PART I. DIAGRAM OF OPERATION.

Principles of the theory of two reactions. I have long been surprised that polyphase alternators and direct-current machines have not been treated from the point of view of reaction, since these phenomena are fundamentally of absolutely the same order, since the dephasing alternating current produces effects of the same order as the displacing of the brushes in a direct-current dynamo. It is known that in the latter case the displacement causes a direct magnetic reaction to be developed, whilst in the neutral position, there is only a transverse reaction. By a similar reasoning upon the automatic dephasing of alternating currents and of the property which polyphase currents possess of being decomposed into wattless and wattless components, I have been lead to the following proposition:

When an alternator supplies a current dephased by an angle ψ with respect to the internal induced e.m.f., the armature reaction may be considered as the resultant of a direct reaction produced by the wattless current $\sin \psi$ and a transverse reaction due to the watt current $I \cos \psi$.

In addition to the above, the stray magnetic fields must be taken into account, which produce a field proportionate to the currents and in phase with them. We will consider them later on.

The second fundamental proposition of this theory is the following:

The two reactions (direct and transverse) and the stray flux take place in three different magnetic paths; only the direct reaction acts in the main circuit of the field magnets, while the transverse reaction and the stray fields act, in general, upon circuits of low magnetic density.

The conclusion which I have drawn from the above is that, in general, the direct reaction should be expressed under the form of a counter m.m.f.; that is to say, by a number of ampere-turns equivalent to the effect of the armature⁶

$$\frac{KN}{2} I \sqrt{2}$$

8. No notice is here taken of one of the cases considered by the author in 1899; namely, that in which all the machine is well below satura-

calling K a coefficient of reduction. I have formerly given for asynchronous motors a practical value which is approximately the same for alternators, viz.:

$$K = \left(\frac{2}{\pi}\right)^2 k$$

k being the coefficient of reduction which appears in the formula of e.m.f. written under the form

$$E = \frac{k \omega N \phi \times 10^{-8}}{2 \sqrt{2}}$$

Here N is the number of peripheral wires for one phase and ω the velocity of pulsation. It is the direct reaction which produces, almost entirely, the variation of terminal voltage. As to the transverse reaction and the reaction of stray fields, with the assumption that the armature is unsaturated, as I assumed and as M. Guilbert also assumes, they may be expressed simply by the coefficients of self-induction l and s .

More recently I have indicated⁹ that the transverse reaction could also easily be expressed in ampere-turns.

The analysis of the phenomena taking place in the alternator leads therefore to a new proposition, formulated in my articles of 1899.

The dephasing ψ of the current is regulated entirely by the numerical value of the transverse reaction, which, on the contrary, has little effect upon the e.m.f.

This proposition has been demonstrated in the case of unsaturated armatures, as I have just stated, but it is general and remains in effect even in the case where the circuit of the transverse reaction approaches saturation. The demonstration of this will be given below.

tion, because it is only susceptible of very rare applications; moreover, it has been treated with more detail by M. Jean Rey in a very interesting communication presented to the Congress of 1900, in which the reader will find an interesting example of a calculation of reactive coefficients in a machine actually built by this method, which has since been followed by various authors.

9. "Theory of Synchronous Motors," Vol. I. Paris, Gauthiers-Villars, 1900.

Diagram of E.M.F.s. and Currents of an Alternator with Unsaturated Armature and with Saturated Field Magnet.

The diagram in Fig. 1 reproduces Fig. 5 of my first paper, supplemented by the definitions of Fig. 2. r' represents the apparent resistance, that is to say, the ohmic resistance augmented by the effects due to Foucault currents; φ is the difference of phase in the external circuit, and Ψ is the difference of phase with respect to the internal e.m.f. It is proposed to calculate the excitation necessary to develop an e.m.f. U at the terminals under a current-

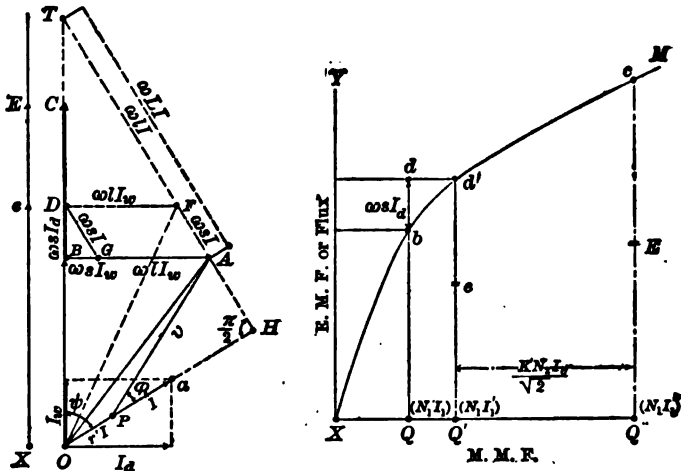

FIGS. 1 AND 2.

delivery I dephased by φ . We have $OP = r' I$ and $PA = U$, with the angle $APa = \varphi$.

Let OT be the direction, as yet unknown, of the internal e.m.f. e ; the perpendicular AB let fall from A upon OT is the sum of the transverse reaction:

$$AG = \omega l I \cos. \Psi$$

calling l the transverse self-inductance and ω the speed of pulsation; and of a part of the stray-field reaction

$$GB = \omega s I \cos. \Psi^{10}$$

calling s the self-induction of the stray fields.

The segment GD perpendicular to I represents the e.m.f. of reaction of the stray fields $\omega s I$, and the segment

$$BD = \omega s I \sin. \Psi$$

10. The segment BT intercepted upon OT will evidently be equal to

$$BD + DT = \omega l I \sin. \Psi + \omega s I \sin. \Psi.$$

represents the second component of the stray-field reaction; thus in OD is obtained the value of the effective e.m.f. e , which should be obtained by the resultant excitation.

The value of the angle Ψ is determined by expressing simply the relations between the elements of the figure. Let us analyse the broken line $OPAB$ into components upon OB , and BA ; whence

$$e = r^1 I \cos. \Psi + U l \sin. (\Psi - \phi)$$

$$\omega (l + s) I \sin. \Psi = r^1 I \sin. \Psi + U \sin. (\Psi - \phi)$$

and

$$\tan \Psi = \frac{U \sin. \phi + \omega (l + s) I}{U \cos. \phi + r^1 I}$$

The angle of real dephasing Ψ is thus determined solely by a knowledge of the transverse reaction. This equation, which was given by the author in 1899, is evidently equivalent to the following construction.

From the point A a perpendicular AH is drawn to the direction of the current I , and a segment AF is drawn upon this line equal to $\omega s I$; then a segment $FT = \omega l I$; finally the point O is joined to the point T , and thus is obtained the angle Ψ and the position of the required vector OD representing the total effective e.m.f. e . To determine the necessary ampere-turns for the production of this e.m.f., it is only necessary to employ the characteristic of excitation of the alternator.

Diagram of Ampere-Turns in the Case of Unsaturated Armature.

The consideration of ampere-turns does not need to appear in the method, as is evident in the case of an unsaturated armature, until after having traced the diagram of e.m.fs. The excitation ampere-turns are drawn, if desired, along the direction of the vector OC , in order to facilitate certain comparisons; but the calculation of ampere-turns is no longer in this method a vectorial, geometric calculation, but a scalar calculation, and may be made upon the characteristic of the excitation of the armature as calculated or drawn, which represents the induced e.m.fs. (or the useful flux traversing the armature) as a function of the total ampere-turns applied on the field magnets.

Their determination is based on the following facts:

1). The wattless, counter-ampere-turns of the armature are proportional to the number of peripheral wires on the armature per

double field N_2 , which supply a number of turns equal to $\frac{N_2}{2}$; but these turns do not act in unison, partly because they belong to different phases, and partly because they are not in the same slots. For this reason it is necessary to apply a reduction-coefficient K_2 . The effective wattless current $I_2 \sin \psi$, thus gives rise to an e.m.f. exactly opposite to that of the field magnets, and having for its magnitude in counter-ampere-turns

$$\overline{CAT} = \frac{KN_2 I_2 \sin \psi \sqrt{2}}{2}$$

2). These counter ampere-turns act, on the one hand, upon the circuit common to the field magnets and the armature; and on the other hand, upon the circuit of the armature and of the stray magnetic fields. This may be represented diagrammatically as in

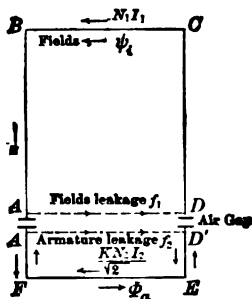

FIG. 3.

Fig. 3, in which the full lines $ABCDEF$ represent the principal magnetic circuit with its two m.m.f.s. acting in the opposite directions $N_1 I_1$ and $\frac{KN_2 I_2}{\sqrt{2}}$, and the dotted lines $ADAD$ indicate the stray circuits in which the lines of force escape, either between the teeth of the armature f_2 or between the polar horns f_1 . In reality the stray fields f_1 of the field magnet are not concentrated along any single path but are spread out more or less over the entire length of the principal circuit up to its entrance into the armature turns. This fact is, however, unimportant, as has recently been shown by M. Guilbert (see *Éclairage Électrique*, December, 1903).

3). The self-induction of the armature is produced by the stray fields f_2 supposedly attributed to the effect of the armature. If

we call R_{f_2} the reluctance of the circuit of the stray fields f_2 , and R_a the reluctance of the armature, the stray field produced by the armature across itself is expressed in practical units (N_2 being the number of peripheral wires per field),

$$f_2 = 0.4\pi \left\{ \frac{K N_2 I_2 \sqrt{2} \sin. \psi}{2 (R_a + R_{f_2})} \right\} = \frac{0.2 \pi K N_2 I_2 \sqrt{2} \sin. \psi}{R_{f_2}}$$

assuming that we can neglect R_a with respect to R_{f_2} , and thus produce an e.m.f

$$E_f = \frac{k N_2 \omega f_2}{2\sqrt{2}} = \frac{k N_2 \omega \times 0.1\pi K N_2 I_2}{R_{f_2}}$$

It results from this that the e.m.f. of self-induction that we have called $\omega s I_2$ can be considered as produced simply by a stray field f_2 , which is added to the stray field of the field magnets f_1 .

Upon the total characteristic OM (Fig. 2) defined as above, the point b which corresponds to the e.m.f. OB represents the NI turns necessary to force the useful flux through the field magnets into the armature (proportional to OB). Adding to the flux Φ_s the stray field of the armature f_2 , there is obtained the virtual e.m.f. $BD = e$, corresponding to the total flux emanating from the poles into the entrefer; the corresponding abscissa XQ' represents the necessary field-winding ampere-turns $N_1 I_1'$ without taking into account the increase Δf_1 of the stray field f_1 of the field magnet.

4). The stray field of the field magnets f_1 is proportional to the reluctance of the stray path R_{f_1} between the poles and the difference of magnetic potential between the poles. This latter is formed of two parts; one part is the drop of magnetic potential necessary to force the flux through the armature and entrefer, the other part, the wattless counter-ampere-turns of the armature calculated as above.

5). Every increase in the ampere-turns of the field magnet, increases the stray flux f_1 of the field magnet, in a manner sensibly proportional to the increase of the ampere-turns of the field. If, therefore, the field-magnet ampere-turns are increased by

$$KN_2 I \frac{\sqrt{2}}{2}$$

in order to compensate for the counter-ampere-turns \overline{CAT} of the armature, the stray flux f_1 produced by the field magnet following the circuit $BACD$ would be increased by a quantity.

$$\Delta f_1 = \frac{0.2\pi KN_s I \sqrt{2}}{R_t + R_{f_1}} = \frac{0.2\pi KN_s I \sqrt{2}}{R_{f_1}} \text{ approximately } = \frac{(CAT)}{R_{f_1}}$$

R_t being the reluctance of the field magnet.

This increase of the flux through the field magnet increases the magnetic density in the latter and demands consequently a correction, as I pointed out in 1899, without tracing it in detail. At that time I conducted the inquiry simply as follows, supposing the rôle of the field magnets to be sufficiently unimportant to permit approximate correction being applied.

Let B_1 be the flux density in the field magnet, corresponding to the no-load e.m.f. e , that is to say, to the flux $\phi_a + f_1$; and let us call v_1 the Hopkinson coefficient $\frac{\phi_a + f_1}{\phi_a}$. The full-load induction will be

$$\begin{aligned} B_1' &= B_1 \frac{\phi_a + f_1 + \Delta f_1}{\phi_a + f_1} = B_1 \left\{ 1 + \frac{(CAT)}{R_{f_1} (\phi_a + f_1)} \right\} \text{ approximately} \\ &= B_1 \left\{ 1 + \frac{(CAT) f_1}{N_1 I_1 (\phi_a + f_1)} \right\} \\ &= B_1 \left\{ 1 + \frac{(CAT) v_1 - 1}{N_1 I_1 v_1} \right\} \end{aligned}$$

and consequently the total ampere-turns will be increased by the quantity of which the change from B_1 to B_1' increases the ampere-turns (which we shall call $N_1 I_1$) specially absorbed by the reluctance of the field magnets in the condition considered. The point d upon the curve will be in consequence displaced towards the left by the quantity corresponding to this increase of ampere-turns. Starting from the point Q' duly corrected, it is sufficient to take a length representing the ampere turns equal to CAT of the armature in order to obtain the total necessary ampere-turns OQ'' . Fig 4 shows how the diagrams of e.m.fs. and of ampere-turns may be united upon a single sheet.

The preceding reasoning may be summed up in the following simple equations, employing ordinary language.

The fall of magnetic potential in the armature and entrefer = a function of the flux utilized in the armature $\phi_a +$ the armature stray flux f_2 .

The magnetic difference of potential between the pole pieces = the fall of magnetic potential in the armature and entrefer + the wattless counter ampere-turns of the armature.

the flux Δf_1 only follows the magnetic circuit to the point of emergence of the flux from the field magnets, and only absorbs consequently the fraction $\frac{R_1}{R_{total}}$ of the ampere-turns which would be necessary to make it traverse the entire magnetic circuit. The virtual self-induction s which may be advantageously assumed, will then have an approximate expression

$$s = 0.1\pi Kk N_s^2 \left(\frac{1}{R_{f_s}} + \frac{R_t}{R_{total}} \frac{1}{K_{f_1}} \right)$$

and this should be employed in the determination of the segment BD , as above.

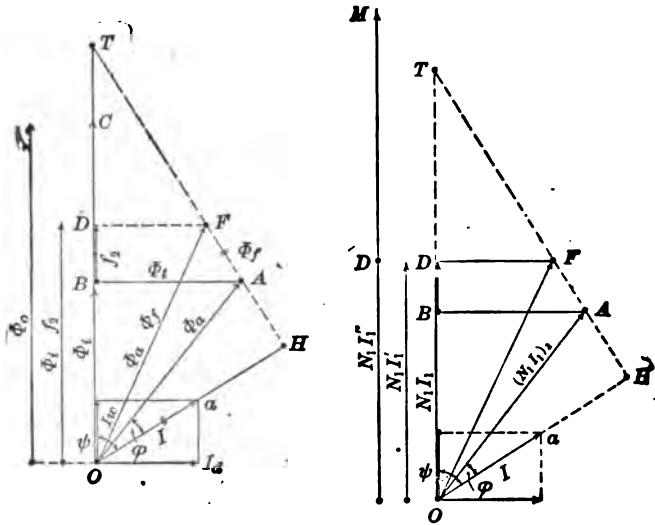

FIGS. 5 AND 6.

In order to have the total necessary field-magnet ampere-turns $N_1 I_1''$, it is no longer necessary to add any excitation upon the field magnets except the ampere-turns equilibrating those of the armature $\frac{KN_2 I_2 \sqrt{2}}{2}$. The total ampere-turns OQ'' are thus obtained.

If the armature current were suddenly suppressed, an e.m.f. $E = Q''c$ would appear in the armature on open circuit, which is that appearing with the same notation in Fig. 5.

The same construction may serve reciprocally to calculate the fall of potential produced in an alternator having the excitation OQ'' for the wattless current I_a in the armature.

Remark No. 1, Upon the Case of an Unsaturated Armature.

When the armature and the pole pieces are not saturated, the diagram of e.m.fs. (Fig. 1) is also a diagram of the flux, to a different scale, if care be taken to divide the values of the e.m.fs.

by the coefficient $\frac{k \omega N_s}{2\sqrt{3}}$.

Similarly, having given the magnetic reluctances sensibly constant for the direct flux of the armature and for the transverse flux (excluding the field magnet core), the same diagram may also present to a suitable scale the m.m.fs. proportional to the flux, multiplied by the reluctance of the armature, of the entrefer, and of the pole-pieces respectively. In that case, OA represents the necessary ampere-turns to force the flux through the said reluctance. OB is the part of this e.m.f. furnished by the field magnets; AB the part furnished by the armature; BD the supplement necessitated by the stray field of the armature.¹¹ DF represents the ampere turns of distortion

$$DF = \text{function of } \frac{K_t N_s I_w}{\sqrt{2}}$$

Calling K_t a coefficient of distortion analogous to the coefficient K of the direct reaction, and f the relation which connects the ampere-turns to be produced by the field-magnet with those utilized in the armature, similarly we have

$$FT = \text{function of } \frac{K_t N_s I}{\sqrt{2}}$$

The total ampere-turns necessary to the emergence of the flux from the field magnets will be determined as above (Fig. 4): let OQ'' represent the magnitude equal to $N_1 I_1''$, to the scale of the new figure; the distance Dd will evidently represent the ampere-turns absorbed by the field alone; it is this length Dd which would in general be corrected by taking account of the stray field Δf_1 . The method of correcting the stray fields indicated above may be employed; we will give further on another more nearly accurate—already suggested, moreover, by MM. Picou and Guilbert.¹²

11. And eventually by the supplementary stray fields Δf_1 in the particular case indicated above, where the effect of the stray field from the field magnets is referred to a supplementary term of the armature stray fields.

12. The diagram of the present figure is analogous to a diagram recently published by M. E. Guilbert (*loc. cit.*); it differs, however, in that the

Remark No. 2, Upon the Subject of Diagram No. 1.

It is to be observed that following the respective values of the reactive coefficients, both direct and transverse, the point C , the extremity of the available e.m.f. on open circuit, may be either above or below T .

With an alternator of unsaturated field magnets, the two reactions have coefficients nearly equal, and C may then coincide with T , when they are equal. Ordinarily, the coefficient of distortion tends to be reduced, as we shall see, by a reduction in the breadth of the poles, while the coefficient K has the opposite tendency. It results from this that C tends to be above T . But the saturation of the field magnets lowers it the more as the saturation is greater; because this latter augments but slightly the supplementary ampere-turns necessary to compensate for those of the armature, but greatly diminishes the variation of the voltage between open circuit and full-load. C is, therefore, in general below T , as represented in the diagrams.

The same condition may be found even with saturation, with certain types of alternators, such for example as that which was exhibited in 1900, in Paris, by the firm Sautter-Harlé. This machine, developed along a plan, formerly patented by Professor E. Thomson, of an iron rotor (inductor alternator), has a single armature, two exciting field-windings, and a yoke closing the magnetic circuit through the shaft of the field magnet. It presents a supplementary entrefer of considerable reluctance around the shaft, and this entrefer is traversed only by the direct reaction. The coefficient of direct reaction is therefore rendered smaller than that of the transverse reaction, and if the supplementary stray fields Δf_1 , analysed above, are not exaggerated, C will remain below T .

Those theoretical diagrams are not, therefore, liable to criticism which show C below T . To propose placing C always on T , as Professor Arnold has done,¹³ is contrary to the purpose of this method, namely, the calculation of the effects of saturation and of distortion according to rational principles.

line FE is expressed as a function of the coefficient K_t instead of the coefficient K and that the expression of dephasing ψ is thus presented as a function of the ampere-turns.

13. E. Arnold, *Elek. Zeit.*, 1902, page 250.

The Case of a Saturated Armature. (Figure 7.)

The theory of two reactions permits also of treating the case of a saturated armature, by employing with the total characteristic, the characteristic of the armature alone (comprising the armature-entrefer, and pole pieces), already employed moreover by MM. Bauch, Potier, Guilbert and Picou.

For greater clearness of explanation, I shall represent the characteristics upon the same diagram, but, in practice, they would

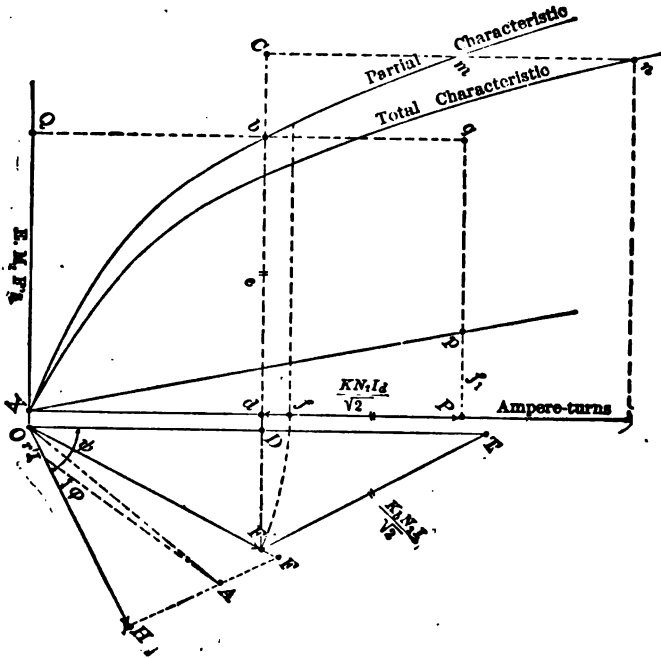

FIG. 7.

be drawn upon separate figures. The curves are referred to the e.m.fs. as common abscissas, and the ordinates of the two curves represent respectively the ampere-turns for the passage of a given flux (corresponding to the e.m.f.) in the magnetic circuit, with or without the field magnets. The difference of the ordinates equals then the ampere-turns absorbed by the field magnets alone, in the absence of stray magnetic fields.

This assumed, we shall then construct, according to custom, the

diagram of e.m.fs. by adding to the voltage at the terminals U the internal drop $r'I$, then the loss by stray magnetic fields ΔF . We thus obtain the e.m.f. produced in the armature OF . We find upon the characteristic of the armature and ampere-turns OF' corresponding to this e.m.f., and we lay them off on OF' in the direction of OF .

We may then observe that the distortion may be determined by the comparison of the ampere-turns of distortion with the useful ampere-turns in that part of the machine which does not include the field-magnets; because, in the transverse reaction, the reluctance of the pole-pieces may be neglected in relation to that of the entrefer and of the armature (especially that of the teeth), and consequently attribute to the path of this reaction the same reluctance as in the path of the useful flux outside the field magnets. The determination of the angle ψ (Fig. 1) will then be transformed into simply replacing the self-inductance by the m.m.fs.

applied to the armature. The ampere-turns $F'T = \frac{K_t N_s I}{\sqrt{2}}$

will be laid off in the direction perpendicular to I , and OT is joined; then from F' the perpendicular $F'D$ is dropped, which will be equal to the ampere-turns of distortion

$$DF' = \frac{K_t N_s I_w}{\sqrt{2}}$$

The line OD will then represent the ampere-turns to be supplied by the field-magnets at the point of emergence, the remainder DF' being furnished by the armature itself.

It remains to determine the total field-magnet ampere-turns corresponding thereto, taking into account the reluctance of the stray flux of the field magnets, properly so-called. For this purpose it suffices to seek upon the characteristic of the armature the corresponding e.m.f. $Db = e$; the ordinate Qb corresponding to this abscissa e upon the curve of the armature measures the necessary ampere-turns to be produced between the poles, the necessary stray fields f_s included. We add thereto the ampere-turns equilibrating the direct reaction of the armature, that is to say,

$$bq = \frac{KN_s I_a}{\sqrt{2}}$$

The ordinate Qq represents the difference of potential (subject to the factor 0.4π) necessary between the poles of the field magnet. From this may be deduced the value of the stray field f_s between

the pole-pieces which may be presented, for example, as a function of the difference of potential along the curve XP , which is sensibly a straight line; Pp will then represent the stray field f_1 .

If, starting from b , a segment bC be drawn representing Pp (measured to the same scale as the flux db corresponding to the e.m.f. e), and through C we draw the straight line Cm parallel to OP , the latter will contain between the two characteristics a segment mn which will represent the fall of magnetic potential in the field magnets under the influence of the total flux dC . The total necessary m.m.f. will thus be equal to $OP + mn$.

The diagram is thus established, taking into account the stray field both of the field magnet and of the armature. It is distinguished from those of Potier,¹⁴ Rothert,¹⁵ and Bauch,¹⁶ because it takes into account the transverse reaction with its real value; it takes account of the difference between the two coefficients of reaction K and K_1 , and is thus distinguished from the diagram of M. Guilbert¹⁷ for unsaturated field magnets; it finally differs in diagrammatic construction from the very ingenious diagram of the same author for saturated field magnets in the fact that it does not separate the entrefer from the armature, and is also much more simple.

Summing up, the employment of the diagram in Fig. 4 is to be recommended for the case in which there is no appreciable saturation either in the armature or in the field. In all other cases it seems preferable to employ the diagram Fig. 7, which lends itself better to determining the different elements, without complications.

If it is desired to solve the inverse problem, that is, to determine the fall of potential under constant excitation as a function of the load, the preceding diagrams do not give a direct solution, but it is easy to employ them for an indirect solution, particularly in assuming constant the external dephasing φ , and taking successively different values of the wattless current; for each value of I_d the preceding construction will be followed in the opposite direction, and thus will be obtained the voltage at the terminals, the values of ψ and of I_w . Thus may be traced a curve of voltage u as a function of I_d , and of I which is obtained therefrom. It

14. Potier, *Bolairage Electrique*, July 26, 1902.

15. A. Rothert, *Elek. Zeit.*, 1899.

16. Bauch, *Elek. Zeit.*, 1902.

17. M. Guilbert, *Revue Technique*, April and May, 1904.

is only necessary to seek upon this curve the point corresponding to the conditions required and the dephasing angle.

The problem is solved no longer for a single point, but along a complete curve, which is also comparatively easy.

Local Corrections of the Entrefer Due to Saturation (Second Approximation).

The diagram Fig. 7 is established by supposing the reactions act *en bloc* and are represented by coefficients. The same is true of the diagram Fig. 1. But if it be desired to follow the reality somewhat closer, it is well, once the diagram is determined by the aid of the coefficient K (the calculation of which is explained later), to calculate upon the drawing the flux-density of the resulting field at each point along the entrefer, by the aid of magnetic potential curves (to be explained later) and of the local reluctance. In particular, if the teeth of the armature are saturated, they develop marked variations of the reluctance per unit of surface along the entrefer and the flux calculated according to a mean value of reluctance may be sensibly modified thereby. This is the case not only for the transverse reaction, as has already been remarked by certain authors, but also for the direct reaction, which should not be set aside in this correction. The effect of this latter is to reduce the resultant flux. The curve of the diagram is, in fact, a solution of the first approximation necessary in order to determine the dephasing of the values of the watt currents from the wattless currents. After these values have been obtained, a second approximation may be arrived at by tracing the flux-densities from point to point for determining the real flux. In general, however, the precision of the calculations is not sufficiently great to proceed upon this correction unless ample time may be afforded for the study.

Case of Field Magnets with Divided Windings.

In certain machines, particularly turbo-alternators, circular field magnets are found in which the windings are carried along the entrefer in slots like those of the armature. The preceding diagrams (Figs. 1 to 7) apply likewise to these machines only on the condition of assuming the two coefficients of reaction equal even when the field magnet is entirely divided into slots. Moreover, the field-magnet winding must be affected by a coefficient of ampere-turns K_1 , reducing them to $K_1 N_1 I_1$ (with

$K_1 = 0.4$ to 0.5 in completely uniform windings), and by the Hopkinson coefficient v_1 , which is calculated like the stray field of a slot in an asynchronous motor. All the other coefficients are calculated as in the ordinary case, by supposing the breadth of the reactive flux equal to that of the field-magnet poles. This method has given me satisfactory results in practice for this type of machines.

PART II. CALCULATION OF CONSTANTS.

Practical Calculation of Reactions.

In order to apply the diagrams, the coefficients s , l , K_t and K must be determined (l and K_t are of course only two expressions of one and the same coefficient). The stray coefficient is determined by known methods frequently indicated for asynchronous motors, and they need not, therefore, be alluded to here. For K and K_p , I have employed for several years the most direct method, which consists in determining for the same machine on which the curves of distribution of magnetic potential are determined, and of the flux in the entrefer, assuming that the armature is traversed by a known current either watt or wattless. By taking into account the position of the pole-pieces in these two cases, and their form, as well as that of the slots, the reactions may be determined with sufficient precision.

Let us consider, for example, the case of three-phase currents: the three phases occupy in a double field six slots, or groups of slots, and at the passage of each slot, the magnetic potential along the entrefer undergoes a sudden positive or negative increase equal to 0.4π multiplied by the number of ampere-turns $\frac{N}{6}$ contained in the slot. It suffices to mark off on a straight line, representing the development of the circumference of the armature, lengths equal to the distance from the axes of the slots, and on successive ordinates, the variations of the magnetic potential thus calculated. The horizontal mean line is then traced of the curve so obtained, and which indicates the zero of the magnetic potential. The fluxes will be at every point proportional to the ordinate of the curve from the zero point, and inversely proportional to the reluctance per unit of surface corresponding to the abscissa considered. For simplicity, the reluctance may first be assumed constant, and

account is only taken of its variations in order to arrive at a definite correction for a second approximation. To simplify the calculation, there is attributed to the maximum amplitude of the poly-phase currents an arbitrary value I_0 , and it is supposed that the currents follow a sinusoidal law. Since the form of the curves is is

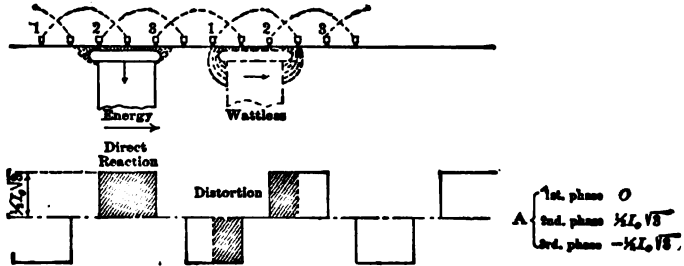

FIG. 8.

reproduced for every one-sixth of a period in the three-phase currents (or in one-fourth of a period in two-phase currents), it suffices to study them during such an interval, and even to outline the extreme forms.

Let us take, for example, a three-phase machine with six slots in the field, each containing $N/6$ wires, calling N the total number of peripheral wires per double field (Fig. 8). The potential produced by each is $0.2 \pi (N/6) i$, calling i the current which traverses the winding, and it suffices to construct the curve of i , to which that of the potentials should be proportional. We take two positions;

one for which the current is nil in the slots 1 and 4 and equals $\pm \sqrt{\frac{3}{2}} I_0$ in the others, the other position for which the current is equal to

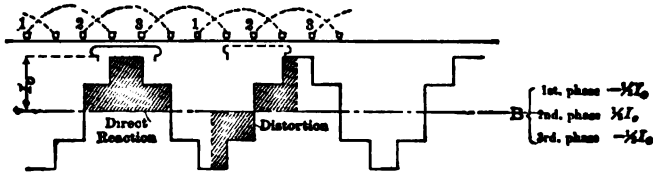

FIG. 9.

I_0 in the slots 1 and 4 and equal to $(1/2) I_0$ in the others. The curves proportional to the potential thus obtained are respectively represented in Figs. 8 and 9. On these figures are added in position and in magnitude the outlines of the field-magnet poles in the

two positions; in full lines the position corresponding to the watt current, that is to say, a pole axis coinciding with the middle of the curve of potential; and in dotted lines the position corresponding to the wattless current, that is to say, the axis of the pole facing the zero of the curve.

The reaction is then deduced from the figure by determining the mean useful ordinate of the curve. Theoretically, this ordinate would be obtained by evaluating the area of the shaded curve situated in front of the pole, and dividing this by the breadth of the pole; but the result so obtained is not practically useful; because it takes no account of the expansion of the lines of force, which greatly broadens the flux, particularly as the entrefer is made larger and the angles of the pole pieces are more rounded. To determine the direct reaction, one must take instead of the breadth of the pole, the breadth of the field-magnet flux which issues from it; and to determine the mean ordinate in this breadth. A similar determination is made for the transverse reaction. It must be observed that the flux which forms it is established not only under the poles but also around them, although with a lesser density. Consequently, this flux occupies a greater breadth in which the mean reaction should be determined. There is, therefore, a large individual liability to error in the appreciation of these reactions, and this should give preference to the complete method of operation here indicated for the employment of theoretical coefficients, which do not take account of the special conditions in each machine. If the breadth of the flux is equal, for example to the

pitch, Figs. 8 and 9 show the mean ordinates $\frac{2}{3} \left(I_0 \frac{\sqrt{3}}{3} \right)$ and $\frac{2}{3}$

I_0 for the direct reaction, and similarly for the transverse reaction. The values give those of the coefficients K and K' themselves, if the ampere-turns obtained are compared with the ampere-turns which would be obtained with the three bobbins united in a single pair of slots and traversed by a current I_0 . The curve of potential

gives $\frac{2N}{6} \left(\frac{2}{3} I_0 \frac{\sqrt{3}}{2} \right)$ instead of $\frac{N}{2} I_0 \times 3$. The ratio gives

the coefficient $K = \frac{2}{3} \left(\frac{2}{3} \frac{\sqrt{3}}{2} \right) = 0.384$.

Thus the coefficients K and K' are obtained simply by taking $\frac{2}{3}$ of the mean ordinates. For two-phase currents, one would similarly take $\frac{2}{2}$, that is to say, unity.

If instead of one slot per phase, there were several, n for example, the mean ordinate would be first divided by n .

In this manner, the following figures would be obtained:

TABLE I.—EMPIRICAL COEFFICIENTS.
Three-phase winding, with three separate coils per double field.

Ratio $\frac{\delta}{\Delta}$ of the breadth of flux to that of polar pitch.	COEFFICIENT K (DIRECT).			COEFFICIENT K_t (TRANSVERSE).		
	Pos. 1.	Pos. 2.	Mean.	Pos. 1.	Pos. 2.	Mean.
1	0.385	0.444	0.419	0.385	0.444	0.419
$\frac{2}{3}$	0.577	0.500	0.538	0.288	0.333	0.310
$\frac{1}{3}$	0.577	0.555	0.566	0.192	0.333	0.2625

In practice an alternator is rarely found where the flux occupies less than $\frac{2}{3}$ of the pitch, and besides in this case a winding of twelve bobbins with six short slots should be taken, in my opinion, instead of the ordinary winding, as will be mentioned further on.

The coefficients of self-induction l and l' , corresponding to the two reactions, are deduced from the values of K and K_t by evaluating the corresponding fluxes and the e.m.fs. which they induce in the windings themselves by means of the ordinary formulas. From this, calling l the winding factor, or the mean value which takes account of the reduction by dispersion of the wires in the e.m.f. produced in the winding by a sinusoidal flux,¹⁸

$$l = \frac{4\pi K_t k \left(\frac{N}{2}\right)^2 10^{-9}}{qR_t}; \quad l' = \frac{4\pi K k \left(\frac{N}{2}\right)^2 10^{-9}}{qR_d}$$

q being the number of phases (here 3), R_t and R_d the reluctances of the transverse and direct circuits respectively.¹⁹

These reluctances are determined upon the same drawing of a

18. See in particular the coefficients in my above-mentioned analysis of the rotating magnetic fields, *Éclairage Électrique*, 1895.

19. In unsaturated alternators, if one calls e the simple entrefer, s the polar surface, and d the coefficients of enlargement of the flux $\frac{1}{R_t}$, and $\frac{1}{R_d}$

the equation is approximately obtained $\frac{1}{R_t} = \frac{s(1+d)}{2e}$.

machine, taking into account the real path of the lines of force and by saturation of the parts through which they pass, particularly the teeth of the armature, the polar horns, the cores, the yokes of the field-magnets, etc.

If, instead of alternate poles, the machine carries poles of the same name (homopolar inductor), K and K_1 may again be determined by the preceding methods, drawing only one inductor-pole for two poles of the armature. It results from this that theoretically the reactions would give rise to coefficients 50 per cent less than in the ordinary case. In practice, however, this is far from being the case, because of the very considerable expansion of the flux reaction of the armature in the large spaces existing between the field-magnet poles. The direct flux reaction and particularly the transverse reaction is, therefore, much larger than if they were produced only by the action of the poles; so that finally the reactions are scarcely reduced more than 25 per cent. The stray fields are, moreover, very large in this type of machine, and every expansion of the field-magnet flux beyond the breadth of the pitch produces a hurtful inverse e.m.f. The induction-density in the entrefer should finally, be doubled at least, to produce the same useful flux on open circuit. From all the above it follows that homopolar machines are of little advantage and are almost abandoned. To completely take into account the practical values of the coefficients, we shall consider again the case of three-phase machines with six coils per field, first concentrated into one pair of slots per coil, and then spread uniformly (or to a large number of slots each) in order to occupy the entire circumference of the armature.

Figs. 11 and 12 represent the curves of magnetic potential obtained in the two hypothetical cases with long bobbins disposed as shown diagrammatically in the figure. The two curves correspond to the same hypotheses as above for currents, and Table II represents the separate mean values obtained from K and K_1 with these curves.

But a winding with six coils may also be realized symmetrically following the plan of Fig. 13, from which two new curves 14 and 15 are obtained. The table also indicates the value of the coefficients thereby deduced.

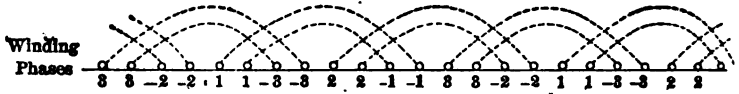

FIG. 10.

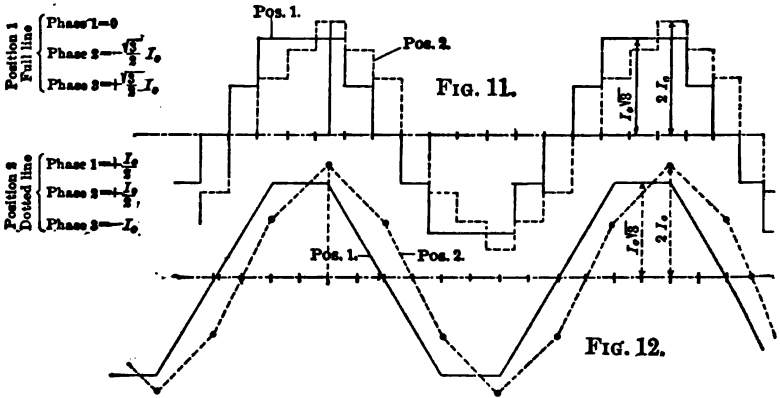

FIG. 11.

FIG. 12.

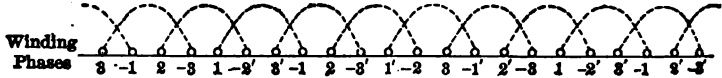

FIG. 13.

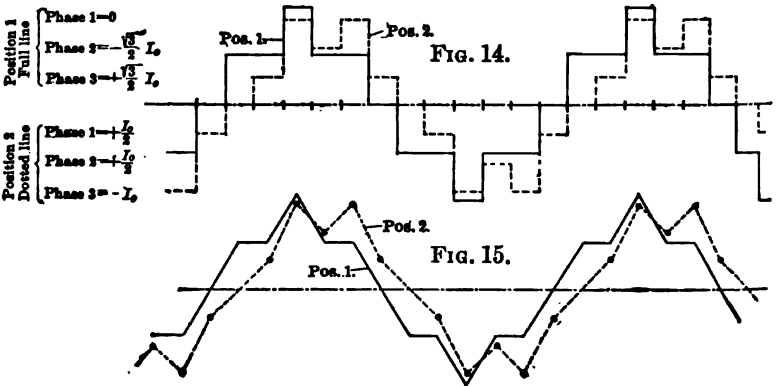

FIG. 14.

FIG. 15.

FIGS. 10 TO 15.

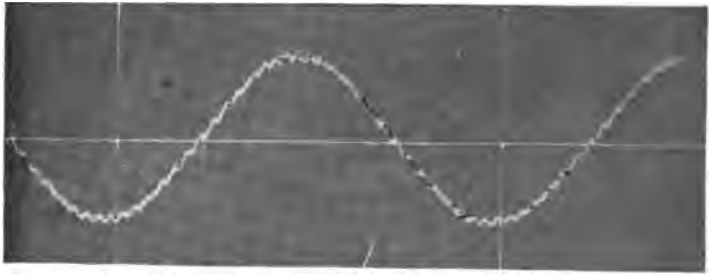

FIG. 13.

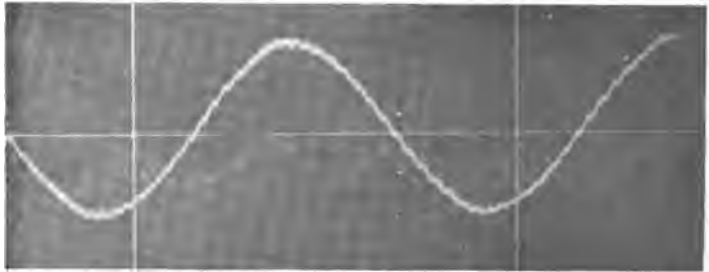

FIG. 14.

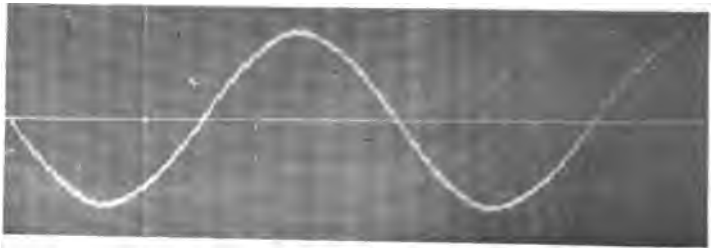

FIG. 15.

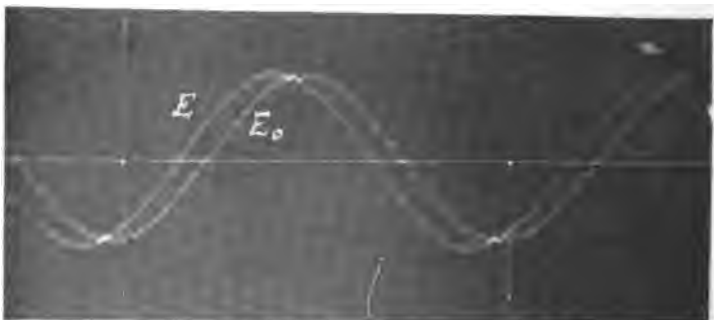

FIG. 16.

TABLE II.—EMPIRICAL COEFFICIENTS.

Three-phase winding with three separate coils per double field.

Ratio $\frac{\delta}{\Delta}$	K.			K_t			
	Pos. 1.	Pos. 2.	Mean.	Pos. 1.	Pos. 2.	Mean.	
Long coils	1.....	0.385	0.389	0.387	0.385	0.389	0.387
	$\frac{1}{2}$	0.505	0.500	0.5025	0.298	0.291	0.2915
	$\frac{1}{3}$	0.577	0.565	0.566	0.192	0.222	0.207
Short coils	1.....	0.2886	0.2777	0.283	0.2886	0.2777	0.283
	$\frac{1}{2}$	0.380	0.375	0.3675	0.216	0.208	0.212
	$\frac{1}{3}$	0.385	0.444	0.415	0.192	0.111	0.152

TABLE III.—EMPIRICAL COEFFICIENTS.

Three-phase distributed winding, 3 or 6 long coils per double field.

Ratio $\frac{\delta}{\Delta}$ breadth of flux to polar pitch.	K.			K_t		
	Pos. 1.	Pos. 2.	Mean.	Pos. 1.	Pos. 2.	Mean.
$\frac{1}{2}$	0.385	0.389	0.387	0.385	0.389	0.387
$\frac{1}{3}$	0.505	0.500	0.5025	0.2886	0.2916	0.290
$\frac{1}{6}$	0.558	0.541	0.547	0.216	0.236	0.226

TABLE IV.—EMPIRICAL COEFFICIENTS.

Three-phase winding with 6 short distributed coils per double field.

Ratio $\frac{\delta}{\Delta}$	K.			K_t		
	Pos. 1.	Pos. 2.	Mean.	Pos. 1.	Pos. 2.	Mean.
$\frac{1}{2}$	0.289	0.277	0.283	0.289	0.277	0.283
$\frac{1}{3}$	0.380	0.375	0.3675	0.216	0.208	0.212
$\frac{1}{6}$	0.385	0.444	0.4145	0.192	0.157	0.1645

Here again it is seen that the direct reactions increase while the transverse reactions diminish when the breadth of the flux (larger than the pole) diminishes. It is moreover determined that the reactions are markedly reduced by the employment of short coils. But it may be readily shown that with a sinusoidal field-magnet flux of a breadth equal to the pitch, the e.m.f. induced in the winding is reduced approximately in the same ratio. In fact, the mean breadth of the short bobbins, Fig. 13, is $\frac{1}{2}$ of the pitch, while the mean breadth of the long bobbins, Fig. 10, is half of the pitch.

The straddling arrangement of coils in Fig. 10 involves only the

coefficient of reduction $\frac{2 \cos. \left(\frac{\pi}{12} \right)}{2} = 0.966$, while the arrangement

of Fig. 13 reduces the e.m.f. in the same ratio as the flux linkage, that is to say, by the coefficient $k = \sin. \frac{\pi}{4} = \frac{\sqrt{2}}{2}$. The two e.m.fs.

are then in the ratio— $\frac{E \text{ short bobbins}}{E \text{ long bobbins}} = \frac{0.707}{0.966} = 0.73$

But the ratio of the coefficients K and K_1 of the two windings gives approximately the same figure. It is to be observed in this connection that for the case of a flux having a breadth equal to the polar pitch, the coefficient K is substantially equal for these two windings, that is, to k of each winding multiplied by $(2/\pi)^2$, which verifies the general law formerly announced and which is alluded to above.²⁰ Hence it follows that the fluxes produced by multiple-coil windings differ but little from the mean value of the theoretical fluxes, and approach the more nearly as the sections are the more numerous, and either as the local variations or fluctuations of the curves between the extreme forms 1 and 2 of the appended figures are damped out by the Foucault currents of the neighboring pole-pieces. The energy expended in these Foucault currents being supplied by the armature, is represented by an augmentation of its apparent resistance r' .

The reactions of two-phase armatures would be found in a similar manner, and it will not be necessary to reproduce it more in detail. Moreover, two-phase machines are more and more becoming supplanted by three-phase, and the latter present reactions of much smaller fluctuations and a better utilization of materials, just as three-phase motors are superior, from this standpoint, to two-phase motors.

Comparison with Theoretical Coefficients.

The theoretical coefficients are easy to establish in the case where a sinusoidal flux is assumed and the harmonics suppressed.²¹ It is

20. In alternators with distributed windings (Figs. 12 and 15), the diagrams of winding 10 and 13 respectively may be employed by assuming that each coil is replaced by a zone of wires occupying along the entrefer a breadth of $1/12$ of the field, or $1/6$ of the polar pitch, and having as median line the old outline of the single bobbin which it replaces.

21. See my above-mentioned memoir of 1899 upon "Rotating Magnetic Fields"; see also Arnold and la Cour's "Vorausberechnung der Ein- und Mehrphasenstromgeneratoren." Stuttgart, 1901.

then demonstrated that the magnetic potential produced by a poly-phase winding of q phases is independent of the number of phases and depends only upon the total number of wires N per double field, and that is represented by a sinusoid whose amplitude is $2NI_0$. The mean potential in the entrefer is therefore $\frac{2}{\pi} 2NI_0$, and the equivalent mean magnetomotive force producing the reactive flux on closed circuit

$$= \frac{0.4}{\pi} 2NI_0 = \left(\frac{4}{\pi}\right)^2 \times 0.4 \pi \frac{N}{2} I_0$$

that is to say, $(4/\pi)^2$ of the magnetomotive force which will give the same turns if they coincide in position and phase. In this case the sinusoid of potential (Fig. 16) is entirely used and the

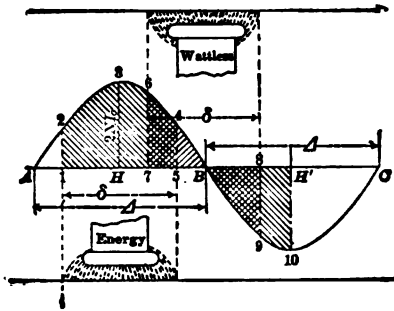

FIG. 16.

direct reaction is proportional to the mean ordinate of the area $A3B$, and the transverse reaction to that of the area $3HBH'10$. If, on the contrary, the reactive flux only occupies a part δ of the pitch instead of Δ , as indicated by the dotted intersecting lines in the figure, the reactions will be proportional to the mean ordinates of the areas 12345 and $67B89$ respectively, limited to the breadth of the flux (which may be different moreover for the transverse flux from what it is for the direct flux). By integrating the area of the sinusoid from $H3$ on to 54 one finds

$$\text{Ordinate of area } 12345 = \frac{\Delta}{\delta} \sin. \left(\frac{\pi}{2} \frac{\delta}{\Delta} \right) \times \frac{2}{\pi} I_0$$

$$\text{Ordinate of area } 67B89 = \frac{\Delta}{\delta} \left[1 - \cos. \left(\frac{\pi}{2} \frac{\delta}{\Delta} \right) \right] \times \frac{2}{\pi} I_0$$

The coefficients which apply to the ampere-turns, resulting from a restriction of the flux, are then respectively for K and K_t ,

$$c = \frac{\Delta}{\delta} \sin. \left(\frac{\pi}{2} \frac{\delta}{\Delta} \right) \text{ and } c_2 = \frac{\Delta}{\delta} \left[1 - \cos. \left(\frac{\pi}{2} \frac{\delta}{\Delta} \right) \right]$$

and have the following values for example (not including k)

for $\frac{\delta}{\Delta} = \frac{3}{4}$; $c = 1.232$; $c_2 = 0.817$ from which $K = 1.232 \left(\frac{2}{\pi} \right)^2 k$
 $K_2 = 0.817 \left(\frac{2}{\pi} \right)^2 k$

" $\frac{\delta}{\Delta} = \frac{2}{3}$; " = 1.299; " = 0.75 $K = 1.299 \left(\frac{2}{\pi} \right)^2 k$
 $K_2 = 0.75 \left(\frac{2}{\pi} \right)^2 k$

" $\frac{\delta}{\Delta} = \frac{1}{2}$; " = 1.414; " = 0.586 $K = 1.414 \left(\frac{2}{\pi} \right)^2 k$
 $K_2 = 0.586 \left(\frac{2}{\pi} \right)^2 k$

TABLE V.—THEORETICAL COEFFICIENTS.

Winding with 8 coils per double field.

Ratio $\frac{\delta}{\Delta}$	SEPARATE COILS.		DISTRIBUTED COILS.	
	K .	K_2 .	K .	K_2 .
$\frac{3}{4}$	0.405	0.405	0.3859	0.3859
$\frac{2}{3}$	0.526	0.304	0.501	0.2397
$\frac{1}{2}$	0.573	0.237	0.544	0.2257

TABLE VI.—THEORETICAL COEFFICIENTS.

Winding with 6 coils.

Ratio $\frac{\delta}{\Delta}$	SEPARATE COILS.		DISTRIBUTED COILS.		
	K .	K_2 .	K .	K_2 .	
Long coils....	$\frac{3}{4}$	0.391	0.391	0.3859	0.3859
	$\frac{2}{3}$	0.508	0.296	0.501	0.2397
	$\frac{1}{2}$	0.558	0.228	0.544	0.2257
Short coils....	$\frac{3}{4}$	0.286	0.286	0.2825	0.2825
	$\frac{2}{3}$	0.371	0.215	0.3665	0.212
	$\frac{1}{2}$	0.404	0.167	0.399	0.164

Since these figures must also be modified in every case by the coefficient k corresponding to the e.m.f, as has been explained above, it is evident that they will differ but little from those of Table II. But it is not the less necessary to determine, from a drawing of the machine, the breadth of the flux before applying it in these formulæ, and therefore to correct the reactions in order to take account of the saturation of the different parts of the armature and of the pole-pieces.

This correction is made by assuming the magnetic conditions which are approximately attained in the machine at full load. The mean flux-density is then known which must be developed in the entrefer, the teeth, and the pole-pieces, and, moreover, one has from the curves of potential the value of the magnetomotive forces acting at all points of the entrefer. From this may be deduced the real flux-density at every point, and consequently the true variation of the total flux produced by the reaction. These expressions of self-inductions given above should be consequently replaced by the integrals of the form

$$l = \frac{N}{q^2 \sqrt{2} I_0} \int \left(0.4 \pi \frac{N}{6} \frac{y b}{R_s} \right) dx$$

indicating by x the abscissa, and by y the ordinate of the curve, and R the reluctance per unit of surface at this point. b represents the length of the armature, q the number of phases, N the number of peripheral wires per field.

Case of Single-Phase Alternators.

The problem of the reactions of single-phase alternators is more complex than that of polyphase alternators, as will be seen. It does not appear to have been fully understood by the authors who have previously treated it. It may be analysed by the same method as that which I have formerly developed for asynchronous motors,²² but taking into account this important difference, that, in general, the rotating reactions (rotating magnetic field with respect to the armature, which we suppose fixed), are suppressed in motors by the short-circuited windings on the rotor, but not in alternators, except in the case where they are furnished with massive poles, or especially with the dampening plates of Leblanc, (which however only give a partial suppression).

I have shown that each coil of a single-phase armature produces

²² Blondel, "Properties of Rotating Magnetic Fields," *Éclairage Électrique*, May, 1898.

a reactive flux capable of being decomposed in space into sinusoidal harmonics, of which the first, the only one which need be considered in practice, has for amplitude $\frac{0.4 \pi nI}{R}$, denoting by nI , the

ampere-turns of the coil, and by R , the reluctance of the magnetic circuit traversed by the flux which it produces. In accordance with the theorem of Leblanc, I decompose this pulsating sinusoid into two rotating sinusoids of one-half amplitude: one turning synchronously with the rotor, and which is not displaced therefore with respect to the field-poles; it provides only a fixed reaction; the other rotates in the opposite direction and with the same speed and is therefore displaced with respect to the field magnets, with a speed double that of synchronism; this gives rise to a pulsating flux in the field magnets of frequency double that of the magnet induced in the armature, as I have also shown experimentally.²³ This reaction is somewhat weakened by the currents which it produces in the closed circuit of excitation, but it is not completely extinguished and produces therefore an e.m.f. of normal frequency in the armature which should be taken into consideration. But, while the fixed reaction may be analysed, exactly as in polyphase alternators, into direct and transverse reactions, the parasitical rotating reaction is effected directly through the field magnets, as well as transversely through the pole-pieces, and may be represented, consequently, by a mean coefficient of self-induction similar to the self-induction of the stray field ωs , to which it is added.

It may be directly demonstrated by calculations that this analysis readily lends itself to the interpretation of the facts,²⁴ and that

23. Blondel, "Photographic Record of Periodic Curves," *Lumière Électrique*, August, 1891.

24. In fact, the self-induction of the armature L , varying between the two values λ and λ' according to position, may be represented by an expression

$$L = A + B \cos. 2 \omega t + \omega s$$

and abbreviating: $A + B = \lambda'$; $A - B = \lambda$

indicating always by s the inductance of the stray fields in the slots. - Let $e = E_0 \sin. \omega t$ be the internal e.m.f., and $i = I_0 \sin. (\omega t - \psi)$ the strength of the current, and there is immediately obtained as the difference of potential at the terminals of the machine the following expression

$$u = e - ri - L \frac{di}{dt} - i \frac{d\lambda}{dt} - \omega s \frac{di}{dt}$$

a single-phase alternator whose armature at rest presents a self-induction λ when the poles are crossed, and an inductance of λ' when they are coincident, behaves under load, when the real dephasing is ψ for example, as though the watt current $I \cos. \psi$ traversed an inductance $\frac{\lambda}{2}$, the wattless current $I \sin \psi$ an inductance $\frac{\lambda'}{2}$, and the total current I a parasitic inductance $\frac{\lambda + \lambda'}{4}$ equal to the mean of the two preceding.

In order to take into account the Foucault currents of the armature produced by the rotating reaction, it is sufficient to apply a reducing coefficient m to its inductance, which is less than unity, evaluated according to the conditions of construction, and at the same time to increase the apparent resistance of the armature in accordance with the energy lost in these Foucault currents, since it is furnished by the armature. It is for this reason that we attribute to this resistance a value $r' > r$ in all of our diagrams.

If the field magnets or the armature of the alternator are saturated, the direct and transverse self-inductances will be replaced by equivalent back ampere-turns, again calculated as in my theory of rotating field: the sinusoid of the amplitude $0.2 \pi nI$ presents the mean ordinate $2/\pi$ times smaller and is consequently equivalent to $\frac{nI}{10} \left(\frac{2}{\pi}\right)^2$ ampere-turns. The value of K and K' will

Replacing e, I, t by their values, and neglecting a term $\frac{B\omega}{2} \cos. (2\omega t - \psi)$ which produces an upper harmonic. There remains—

$$\begin{aligned} u &= E_0 \sin. \omega t - r I_0 \sin. (\omega t - \psi) - \omega \left(A - \frac{B}{2} \right) I_0 \cos. \psi \cos. \omega t \\ &\quad - \omega \left(A + \frac{B}{2} \right) I_0 \sin. \psi \sin. \omega t - \omega s I_0 \cos. (\omega t - \psi) \\ &= E_0 \sin. \omega t - r I_0 \sin. (\omega t - \psi) - \frac{(\omega \lambda + \lambda')}{4} I_0 \cos. (\omega t - \psi) - \frac{\omega \lambda}{2} I_0 \\ &\quad \cos. \psi \cos. \omega t - \frac{\omega \lambda'}{2} I_0 \sin. \psi \sin. \omega t - \omega s I_0 \cos. (\omega t - \psi). \end{aligned}$$

The values of $\frac{\lambda}{2}$ $\frac{\lambda'}{2}$ representing that which we have uniformly denoted by l and l' for all the machines in the construction of the diagrams.

therefore be $\left(\frac{2}{\pi}\right)^2$ for a single bobbin if it has the same breadth as the flux. If the winding comprises several straddling coils, the coefficients should be multiplied by the straddling factor of the winding k ; finally if the flux of the poles is narrower than the pitch, it should be multiplied by the factors $\frac{\Delta}{\delta} \sin\left(\frac{\pi}{2} \frac{\delta}{\Delta}\right)$ and $\frac{\Delta}{\delta} \left[1 - \cos\left(\frac{\pi}{2} \frac{\delta}{\Delta}\right)\right]$, respectively the coefficient of direct reaction and the coefficient of distortion for the conditions analysed above.²⁵

To sum up, the case of the single-phase alternator should then be treated exactly by the same general formulae, the same constructions, and the same diagrams as in the case of a polyphase alternator, but under the condition of considerably increasing the stray flux $\omega s I$, adding thereto a term representing the parasitic rotating inductance. The coefficient ωs is thus replaced by $\omega \left[s + m \left(\frac{l + l'}{2}\right)\right]$ values l and l' are calculated by the theoretical coefficient of polyphase machines (see p. 654) (taking into account the saturation of the circuits by the values given to R and R' , as has already been seen above). In this manner a coefficient m of reduction will be determined less than unity, the more or less marked suppression of the parasitic rotating inductance by the Foucault currents induced in the surrounding non-laminated metallic masses, and finally induced in special damping circuits.

Consequences from the Point of View of the Construction of Alternators for Good Regulation.

The theory and the calculation for the reactances just as they have been above analysed, lend themselves to the discussion of the

25. It is of course easy to pass from a single-phase machine to a polyphase machine of two phases, observing that each phase gives a fixed reaction and a rotating reaction of the same amplitude. I have shown in my theory of rotating fields, already alluded to, that the fixed reactions unite in space and are added algebraically while the q rotating, parasitic reactions give rise to a resultant zero. The coefficients K and K_1 are then themselves theoretically expressions in all the machines independent of the number of phases (N designating always the total number of peripheral wires); but the rotating, parasitic self-inductance disappears in polyphase machines. In this manner the return is made to the theoretical coefficients of the polyphase machine.

construction of alternators much better than the old methods. We will proceed to give a few examples of such applications.

A.) In so far as concerns the employment of short bobbins generally abandoned (by reason of the disfavor thrown upon them through windings of only three coils per field, which give terrible pulsations), the winding of six short bobbins which I have indicated (Fig. 13) may be compared with the ordinary winding (Fig. 10) by means of the coefficients calculated above. The relations between the K of the two being the same as between the respective coefficients k of the e.m.f., it is evident that the advantage of the short bobbins from the point of view of reactions, involves a loss of e.m.f. in exactly the same proportion. To re-establish the desired value of the latter, the number of turns of the armature must either be increased—consequently re-establishing the same reaction, or the flux density in the entrefer must be increased, and consequently the ampere-turns of the field-magnets as well as the losses by Foucault currents. The two windings are therefore equivalent from the constructive standpoint when the field-magnet flux occupies the entire polar pitch. However, short bobbins may be treated more rationally by reducing the breadth of the field-magnet flux to $2/3$ of the field-magnet pitch in such a manner that the flux shall be entirely utilized in the coil. Further increasing the flux-density, an e.m.f. is obtained equal to that in long bobbins, and the direct reaction remains in the same ratio with respect to the e.m.f. while the transverse reaction is reduced. The winding of Fig. 13, with a flux having the value of $2/3$ of the pitch, is then that which for a given ratio of counter-ampere-turns of the armature to the ampere-turns of excitation, produces the smallest transverse reaction. This reduction is of considerable importance.

B.) As to the methods of reducing reactions, it results from the preceding that there is no means of reducing the ratio $\frac{K}{k}$. The only means of improving the regulation of alternators are therefore, first, to saturate the field-magnet circuit (which augments the m.m.f. and reduces the variations of e.m.f. at the armature terminals as a function of the wattless current); second, to increase the entrefer, which is less effective; and third, to reduce the transverse reaction, which has the effect of diminishing the dephasing of the diagrams, and consequently the direct reaction, which is proportional to the wattless current. An alternator which would

not have transverse reaction, would have nothing to fear from direct reaction, even if it were enormous.

The methods of reducing the transverse reactions alone are: First, the reduction of the breadth of the flux accompanied by an augmentation of the flux-density in the entrefer, re-establishing the same field-magnet flux at the expense of an increase of the flux-density (but in that case the same result would be obtained by a simple increase of the entrefer), and avoiding an increase in the loss of energy in the teeth; second, the saturation of the polar horns when the pole pieces possess them; third, the addition of longitudinal slots in the field magnets, as in direct-current dynamos. This last method is very effective when the field magnets are saturated and the slots occupy their entire length and are continued partially into the yoke; the reduction of distortion thus obtained involves generally a reduction of the total flux, because the mean permeability of the field magnet is reduced by the inequality of the e.m.fs. established between its two halves; but the augmentation of excitation which results is negligible in comparison with the diminution obtained on the wattless current by the reduction of dephasing.

C.) As to the comparison between single-phase and polyphase alternators, it is seen that not only do single-phase alternators utilize less effectively their materials for the production of energy, because their armature surface is less utilized for e.m.f., but also their armature reaction gives rise to a hurtful, parasitic self-induction which does not exist in polyphase alternators and which reduces their good regulation. This parasitic inductance can only be partially suppressed at a cost of the expenditure of energy equivalent to a considerable augmentation of the apparent resistance of the armature.

RÉSUMÉ AND CONCLUSION.

To sum up, it has been established in this paper that the theory of two reactions of the armature admits of analysing the phenomena of alternators with greater precision than the old theories, besides having the advantage of referring them to conditions similar to those of direct-current machines. Simple diagrams are given applicable to alternators of saturated field magnets and unsaturated armatures (Fig. 4) and even to saturated armatures (Fig. 7) without involving a complicated correction.

It has been indicated how to calculate the coefficients of reaction, not only theoretical, but also actual, values, by means of curves of magnetic potential in the entrefer. Interesting relations have been established between these coefficients and those of the induced e.m.f.

Comparisons have been established between the different types of winding, and the advantages possible for a special winding with short bobbins have been made evident.

It has been shown that single-phase alternators may be treated by the same methods, adding, however, to the inductance of the stray field a parasitic inductance which does not exist in polyphase machines.

Finally the consideration of the transverse reaction has permitted the discussing of a construction in view of good regulation, showing the interest which attaches to reducing the coefficient of distortion in alternators, and indicating the means of such reduction.

The author hopes that, thanks to simplicity of application, much greater than is often believed, and by its relations with the theory of direct-current machines, this method of calculation (in which he has had practical experience for several years) may be of service to designers and satisfy the need of rational precision in this work.

DISCUSSION.

CHAIRMAN RUSHMORE: You have heard the abstract of these very interesting papers by Professor Blondel. He is one of the men to whom all designers owe a great deal—a man very much handicapped by ill health—and I think we in this country are under very great obligations to him for his writings. The method brought out by Professor Blondel several years ago has been used to some considerable extent and also is the foundation of several other methods, that of Professor Herdt, and also the method advocated by Prof. E. Arnold. These papers are now open for discussion.

Prof. V. KARAPETOFF: The question of armature reaction is interesting from a practical standpoint, because it determines the regulation of the alternator. Now, the regulation of an alternator is determined by four factors: The direct reaction of the alternator, the transverse reaction, the armature self-induction and the armature ohmic resistance. Unless a theory contains all of those four factors, we can not apply it for practical work in design. And this is the case with the paper in hand. We have a lot of literature on armature reaction, both transversal and direct. A few years ago only direct reaction was considered as of any importance, but recently Mons. C. F. Guilbert showed that transverse reaction is also of great importance. But we do not know very much about the armature self-induction, and while it is sometimes assumed

that in a good machine armature self-induction is of no great importance, I believe that the results of a short-circuit test could not be used for a predetermination of the regulation of an alternator, unless we know much more than we do about the self-induction of the armature winding. The self-induction of the winding consists again of three parts. There is the self-induction of the parts of the coils in the slots, the self-induction of the end connections, of the parts of the coils outside of the slots, and the mutual induction of different phases. All those three things are comparatively complicated for computation. It is very easy to speak about them and put them into general formulas, but when the question comes to give the numerical value of those three components of self-induction, for a given machine, in a given disposition of coils, it becomes a very complicated one, and different authors give entirely different results.

Now, if we know the results of a short-circuit test on a machine, we still can not predetermine the behavior of that machine under different loads and with different power-factors, unless we can separate the armature self-induction from the armature reaction; and since, as I understand it, the paper of Mr. Blondel treats only of the armature reaction, leaving out the armature self-induction, the matter still remains open so far as I can judge.

CHAIRMAN RUSHMORE: If there is no further discussion of this paper, we will proceed to the paper by M. Boucherot, entitled "The Regulation of Dynamo-Electric Machines with Relation to Varying Speeds," which will be abstracted by Mr. Slichter.

THE KINETIC VARIATION OF ELECTROMOTIVE FORCE IN DYNAMO-ELECTRIC GENERATORS, AND ITS INFLUENCE UPON THEIR WORKING IN PARALLEL.

BY M. PAUL BOUCHEROT.

Much attention is paid today, in contracts made for alternators, to the resultant fall of voltage, when at a constant excitation and velocity, of the current given by the alternator and of the phase of this current. But by a somewhat strange omission nothing, thus far, has been said about the variation of voltage resulting from any variation of speed, and in particular from the diminution of speed which always accompanies an increase of load in an alternator run by any kind of prime mover.

There is no need of a long dissertation to show why this notion is illogical. An alternator may have a very weak reaction, and, on the other hand, be extremely sensitive to variations of speed, if its exciter, supposedly driven on or from the same shaft, is not sufficiently saturated magnetically. What advantage can be derived from an alternator having only 10 per cent fall of voltage at constant speed if, on the other hand, the voltage diminishes 30 per cent for a diminution of speed of 3 per cent? As this diminution of speed of 3 per cent is certainly produced by the load, the fall of voltage will be 40 per cent, that is to say, as great and as harmful as if the alternator had a marked fall of voltage but were not very sensitive to variations of speed.

It would be useful, therefore, to fix the variation of voltage as a function of the speed as well as a function of load.

Two principal cases are therefore to be considered, according as the changes in velocity have a fixed or oscillatory character: for we may pass from one rate of speed to another in a long period of time, sufficiently long for the two velocities to be considered as velocity of output, or we may pass from one rate of speed to another, coming back to the first pretty rapidly, which constitutes an oscillatory output.

We will establish the corresponding variations of voltage, in steady output and oscillatory output, for continuous-current dynamos and for alternators; we will then examine the influence of these variations on the working in parallel of these machines.

KINETIC VARIATION AT STEADY OUTPUT.

I call *kinetic variation of voltage* the ratio defined by the equation:

$$\Delta = \frac{\frac{de}{e}}{\frac{d\omega}{\omega}}$$

ω , being the angular velocity of which an infinitely small variation is $d\omega$;

e , being the voltage of which the variation corresponds to the variation $d\omega$ of the velocity.

It is surely from the standpoint of ratio that we must view it industrially. It is a number; it is, industrially, the percentage of variation of voltage corresponding to a variation of speed of 1 per cent. This number is as a rule greater than 1. It is only equal to 1 in a machine (dynamo or alternator), which is separately excited.

To appreciate the theoretic value of Δ for a dynamo or an alternator, we must necessarily neglect the hysteresis of the field magnets. If we were to take it into account, we should have to make very long and laborious calculations.

DYNAMOS.

First let us suppose that the machine is at no-load, and with shunt excitation. Let us suppose $e = f(i)$ (see Fig. 1) the characteristic at open circuit, and when separately excited, that is to say, the curve of the voltage at the terminals e , at no-load, and a function of the excitation i , for a velocity ω_1 . As a rule, the fall of voltage corresponding to the output of the current of excitation i will be negligible and of the order of experimental errors, but if this were not so, we would draw this curve by causing the machine to deliver, on a variable resistance, a current equal to the current of excitation.

Let us suppose A to be the working point on the characteristic; that is to say, let us suppose e , the working voltage, at the velocity ω_1 for which we wish to know the kinetic variation.

For any speed ω , the voltage is:

$$e = f(i) \frac{\omega}{\omega_1}. \quad (1).$$

If the machine works with auto-excitation, with a total field-resistance r (coils and rheostat), we have $e = ri$; and if we do not interfere with the resistance r , that is to say, if r is constant, we easily deduce from (1):

$$\begin{aligned} \frac{de}{d\omega} &= \frac{f(i)}{\omega_1} + \frac{\omega}{\omega_1} \frac{f'(i)}{r} \frac{de}{d\omega} \\ \frac{de}{d\omega} &= \frac{1}{\omega_1} \frac{f(i)}{1 - \frac{f'(i)}{r} \frac{\omega}{\omega_1}} \end{aligned}$$

And for $\omega = \omega_1$

$$\begin{aligned} \Delta &= \frac{\frac{de}{d\omega}}{\frac{e_1}{\omega_1}} = \frac{de}{d\omega} \frac{\omega_1}{e_1} = \frac{f_1(i)}{e_1 - f_1'(i) i_1} \\ \Delta &= \frac{OB}{OB - BC} = \frac{OB}{OC} \end{aligned}$$

Whence the following very simple construction to determine the kinetic variation in this case: the kinetic variation is equal to the

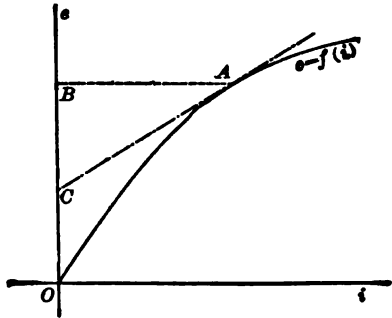

FIG. 1.—OPEN-CIRCUIT CHARACTERISTIC.

ratio of the voltage of operation to that obtained on the axis of the voltages, by prolonging the tangent at the working point to this axis.

It is evident that the construction will be the same for a dynamo at load, on condition that we substitute for a characteristic with open circuit a characteristic obtained by closing the armature on a constant resistance, equal to the equivalent resistance of the actual load.

It is the same for a *series* dynamo, since the equations would be absolutely the same by replacing i by I (main current) and r by R (equivalent resistance of the circuit).

However, in both instances, the resistance R is supposed constant, which is not quite true if the circuit contains arcs, and not at all true if it contains motors or storage batteries having counter-electromotive forces. In that case, the characteristic must be traced, not by closing the armature on constant resistance, but on the circuit itself under actual working conditions. It will then be simpler to determine Δ at once experimentally.

The construction that I have just indicated has no interest except for the predetermination of the kinetic variation Δ , when designing the dynamo.

We possess today means of predetermination sufficiently exact to be able to trace the characteristics of machines in advance of their construction, with sufficient precision to infer the kinetic variation Δ within 10 to 20 per cent, which is quite sufficient. In tracing for each machine the calculated characteristic:

First, with open circuit.

Second, with closed circuit on constant resistance (resistance of full load).

Third, with closed circuit and constant output (output of full load), we shall easily obtain the greatest kinetic variation possible, which may show itself now on one characteristic and then on the other, but oftenest on the third than on the others.

What limit should be assigned to this kinetic variation Δ ? It is evident that the smallest value 1 would be the best; but it can not be obtained, and the values 1.1 or 1.2 would be very costly to obtain, without being necessary, or even very useful. I think the value 2 is a good limit; it is easy to obtain without great expenditure of excitation and it is not excessive if the voltage varies 2 per cent when the speed varies 1 per cent. I fixed on this value for compound alternators, to which I shall refer further on, and which give perfect satisfaction. It is also that

value which we find most frequently in the ordinary dynamos of various manufacture, whether it be specified or not.

It is also well to remark that in allowing a greater kinetic variation, say 3 or 4, we run the risk of having it *greatly increase* for apparently unimportant reasons. For example, it may pass from 5 to infinity, by a decrease in ordinates of hardly 5 per cent, whether this decrease be the result of our voluntarily lessening the voltage, or of our preserving the same voltage with a speed 5 per cent greater.

It is therefore prudent to plan for a kinetic voltage variation not greater than 2.

I will, for the moment, dismiss dynamos with compound excitation; they would lead us too far without being of great interest. Let us note, however, in passing, that with these machines we may take such measures that the kinetic variation will be compensated for simultaneously with the reaction of the armature; that is to say, the excitation must be increased so that the voltage will remain constant when, in consequence of the load, the speed diminishes.

ALTERNATORS.

It is evident that for a separately excited alternator the kinetic voltage variation Δ is equal to 1.

The question is more complex for an alternator having its exciter either at the extremity of its shaft, or run by gear, or belt. We must in this case consider the characteristics both of the exciter and of the alternator. Let us suppose Fig. 2 to represent these characteristics. That of the exciter $e=f(i)$ must necessarily be fixed for armature closed on a resistance equal to that of the field circuit of the alternator (coils plus rheostat). If we seek the kinetic variation of the alternator of no-load, that of the alternator $E=F(I)$ will be established for the alternator with open-circuit armature. These characteristics being still further traced for the velocity ω , the voltages at the terminals are, in general:

$$e = f(i) \frac{\omega}{\omega_1} \text{ and } E = F(I) \frac{\omega}{\omega_1}$$

and as $e = ri = RI$, there results

$$\frac{dE}{d\omega} = \frac{F(I)}{\omega_1} + \frac{F'(I)}{R} \frac{\omega}{\omega_1} \frac{de}{d\omega}$$

$$\frac{dE}{d\omega} = \frac{F(I)}{\omega_1} + \frac{F^1(I)}{R} \frac{\omega}{\omega_1} \frac{1}{\omega_1} \frac{f(i)}{1 - \frac{f^1(i)}{r} \frac{\omega}{\omega_1}}$$

And, for $\omega = \omega_1$, $\Delta = \frac{dE}{d\omega} \frac{\omega_1}{E_1} = \frac{F_1(I)}{E_1} + \frac{F_1^1(I)}{R} \frac{f_1(i)}{E_1 - f_1^1(i) \frac{E_1}{r}}$

$$\Delta = 1 + \frac{O_1 B_1}{O_1 C_1} \cdot \frac{B_2 C_2}{O_2 B_2}$$

Whence a construction again very readily determines in this case the kinetic variation, which is equal to one, increased by the product of two ratios very easy to work out.

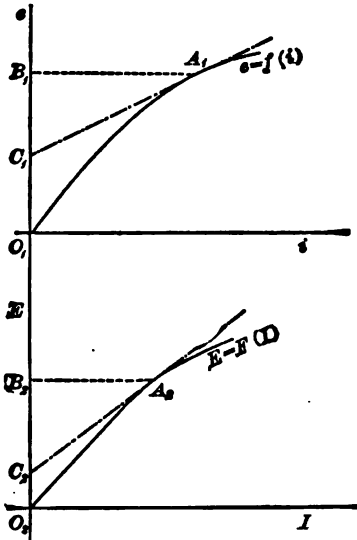

FIG. 2.— CHARACTERISTICS OF ALTERNATOR AND OF EXCITER ON ITS SHAFT.

By calling Δ_1 and Δ_2 the individual kinetic variations, defined like that of an ordinary dynamo:

$$\Delta_1 = \frac{O_1 B_1}{O_1 C_1} \quad \Delta_2 = \frac{O_2 B_2}{O_2 C_2}$$

we have again:

$$\Delta = 1 + \Delta_1 \left(1 - \frac{1}{\Delta_2} \right)$$

In which case again the lesser value of the kinetic variation, corresponding to an alternator *thoroughly saturated* ($\Delta_2 = 1$), is equal to one.

By supposing an alternator and an exciter moderately saturated $\Delta_1 = 2$, $\Delta_2 = 2$, Δ is equal to 2. But for a long time the builders have made ordinary alternators work on the straight part of the characteristic ($\Delta_2 = \infty$) by contenting themselves with moderately saturating the exciter ($\Delta_1 = 2$); whence results $\Delta = 3$.

In a general way, for alternators working on the straight part of the characteristic, the kinetic variation is simply that of the exciter increased by one, which is evident *à priori*.

Here it may be again observed that, as in the case of dynamos, if the kinetic variation exceeds 3 or 4, it may, from some trifling cause, easily attain enormous values, such as 10, or 100.

The formulas remain the same for an alternator with load, if we substitute for the characteristic with no-load the characteristic with load. But here again there are two cases to be considered, depending on whether the alternator is working on an apparently constant resistance or at constant current. Another complication arises from the fact that $\cos. \varphi$ may vary. We will eliminate this variation and suppose, first, so as to examine what is taking place, that $\cos. \varphi$ remains constant. The alternator may be considered as working on constant impedance, if it feeds nothing but lamps and transformers; $\cos. \varphi$ is then nearly independent of the voltage. The alternator may be considered as working almost at constant current (independent of speed), if it only feeds synchronous motors operating apparatus with a constant resisting couple; $\cos. \varphi$ varies then inversely with the voltage, but its variations are generally small. I have represented in Fig. 3 the corresponding characteristics:

OI is the characteristic at no-load.

II III is the characteristic with output and $\cos. \varphi$ constant:

O III is the characteristic with impedance and $\cos. \varphi$ constant. We see that at impedance and $\cos. \varphi$ constants, the behavior of Δ_2 at different voltages is about the same as at no-load.

With both current and $\cos. \varphi$, constant, it is quite otherwise; Δ_2 is small and positive for high voltages, passes by $\pm \infty$ for an average voltage E_1 , and is negative for weak voltages (approximately equal to -1 for E_2 in the figure). $\frac{1}{\Delta_2}$ is therefore positive, but always smaller than 1 for high voltages, zero for the voltage B_1 , and negative for the weak voltages. In giving to Δ_1

a reasonable value, 2, for example, Δ lies between 1 and 3 for high voltages, equal to 3 for the voltage E_1 , and greater than 3, 5, 10 or more, for voltages such as E_2 , smaller than E_1 .

If we take into account that with motors, when the voltage decreases more than the frequency, the output increases, and vice versa, we see how dangerous it may be in certain cases to only concern ourselves with the fall of voltage at constant speed. And we also understand why builders have been led to saturate their alternators more and more. This saturation, resulting in the reduction of fall in the actual voltage, kinetic variation included, which occurs when there is an increase of load.

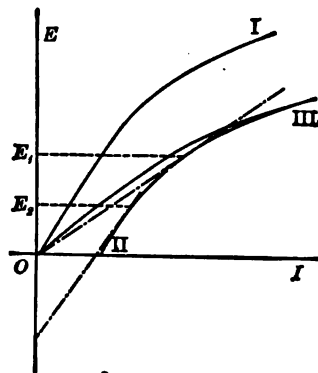

FIG. 3.—CHARACTERISTICS OF ALTERNATOR WORKING AT CONSTANT LOAD INDEPENDENT OF SPEED.

The same observations, with a few variations, might apply to the continuous-current dynamos which feed motors; but we need not delay over this point.

COMPOUND ALTERNATORS.

It is not a question here of alternators with revolving field frames and collector rings, but of standard compounded alternators furnished with a special exciter, in which the continuous current is produced by means of alternating currents issuing from the armature of the alternator, varying in strength with the output and the $\cos. \varphi$ of that output, by the use of a compounded converter, or otherwise.

We will suppose that in such a system the exciter is always sufficiently far from saturation for us to suppose that the currents

and flux are proportional, and that stability is obtained entirely by the saturation of the alternator. The attempts made to do otherwise, that is to say, to saturate the exciter or part of the exciter, have failed. The process of compound winding which is most common in France, and which originated with the author, rests, on the contrary, upon the saturation of the alternator.¹

Let us consider such an apparatus at no-load, and see if it can be compared with one of those which we have just examined.

In the armature of the alternator, the e.m.f. is proportional to the flux and to the speed, or again to the flux and the frequency. It is the same with the exciter, whether we consider the *alternating* side, or the *continuous* side. So that, since the continuous voltage follows exactly the variations of the voltage at the terminals of the armature of the alternator the working is absolutely the same as that of a continuous-current shunt-dynamo. The kinetic variation Δ is simply obtained from the characteristic of the alternator as if we were dealing with a continuous-current dynamo. The author has had various opportunities to verify this. I have also verified that as a result of theoretical considerations, upon which I shall not dwell, the kinetic variation is about the same at load as at no-load, which is the result of the compound winding, properly so called.

Finally, the same observation may be made here as for the compound continuous-current machines; the decrease of speed corresponding to a definite load is always the same in a well-established group of generators in parallel, so that by increasing the compounding influence we maintain constant voltage, whatever the load and speed, the load being invariably connected with the speed. And this is not the least of the advantages of compound winding. But I would wander too far from my subject if I were to demonstrate the insufficiency of the processes which pretend to regulate voltage without regard to speed and which consider frequency as a negligible quantity.

KINETIC VARIATION OF VOLTAGE WITH OSCILLATORY OUTPUT.

When the speed, instead of simply passing steadily from one value to another, oscillates constantly, we must take into account

1. For details on this subject see: *L'Industrie Électrique*, 15 July, 1900; *L'Électricité à l'Exposition*, 2nd number p. 97; *Éclairage Électrique* 1 December, 1900; *Rapports, Congrès Inter. d'Électricité de Paris, 1900*, p. 394; *Bulletin de la Soc. Int. des Électriciens*, June, 1902.

the very great influence of the self-induction of the parts. This influence reduces greatly, as we shall see, the oscillations of the voltage. Because of this, we may merely consider the part of the characteristic on which we work as a straight portion below the bend, which simplifies matters, and permits us to state the voltage explicitly.

DYNAMOS.

Let us suppose a shunt-dynamo at no-load. The speed takes the form:

$$\omega = \omega^1 (1 + \epsilon \sin. \alpha t)$$

By taking into account the remark just made we may write:

$$f(i) = \frac{e_1}{\Delta} \left[1 + \frac{i}{i_1} (\Delta - 1) \right],$$

i_1 and e_1 corresponding to the velocity ω_1 , ($e_1 = r i_1$).

If (r) and (l) are the resistance and self-induction of the field coils, we have

$$\epsilon = r i + l \frac{di}{dt} = \frac{\omega}{\omega_1} f(i)$$

By abbreviating and neglecting what we may, we can write:

$$i = i_1 [1 + \epsilon_1 \sin. (\alpha t - \varphi_1)]$$

with:

$$\epsilon_1 = \frac{\epsilon \Delta}{\sqrt{1 + \frac{\alpha^2 l^2}{r^2} \Delta^2}} \text{ and } \tan. \varphi_1 = \frac{\alpha l}{r} \Delta$$

whence:

$$\epsilon = \epsilon_1 [1 + \epsilon_1 \sin (\alpha t - \varphi_1)]$$

with:

$$\epsilon_1 = \epsilon \Delta \sqrt{\frac{1 + \frac{\alpha^2 l^2}{r^2}}{1 + \frac{\alpha^2 l^2}{r^2} \Delta^2}} \text{ and } \tan \varphi_2 = \frac{\alpha l}{r} \frac{\Delta - 1}{1 + \frac{\alpha^2 l^2}{r^2} \Delta}$$

We will discuss this result farther on.

ALTERNATORS.

Let us call Δ_1 and Δ_2 , the individual kinetic variations of the exciter and of the alternator defined as before.

We have for the exciter (characteristic on resistance R):

$$e = e_1 [1 + e_2 \sin (\alpha t - \varphi_2)]$$

$$\text{with } e_2 = \epsilon \Delta_1 \sqrt{\frac{1 + \frac{\alpha^2 l^2}{r^2}}{1 + \frac{\alpha^2 l^2}{r^2} \Delta_1^2}} \text{ and } \tan \varphi_2 = \frac{\alpha l}{r} \frac{\Delta_1 - 1}{1 + \frac{\alpha^2 l^2}{r^2} \Delta_1}$$

The excitation current of the alternator is then

$$I = I_1 \left[1 + \frac{e_2 \sin. (\alpha t - \varphi_2 - \varphi_3)}{\sqrt{R^2 + \alpha^2 L^2}} \right]$$

$$\text{with } \tan. \varphi_3 = \frac{\alpha L}{R}.$$

R and L being the resistance and self-induction of the field coils, we have then:

$$E = \frac{\omega}{\omega_1} \frac{E_1}{\Delta_2} \left[1 + \frac{I}{I_1} (\Delta_2 - 1) \right]$$

whence: $E = E_1 [1 + e_4 \sin. (\alpha t - \varphi_4)]$, with :

$$= e_4 \left[1 + \frac{2\Delta_1 \left(1 - \frac{1}{\Delta_2}\right) \left[1 + \frac{\alpha^2 l^2}{r^2} \Delta_1 - \frac{\alpha^2 l L}{r R} (\Delta_1 - 1) \right] + \Delta_1^2 \left(1 - \frac{1}{\Delta_2}\right)^2 \left(1 + \frac{\alpha^2 l^2}{r^2}\right)}{\left(1 + \frac{\alpha^2 l^2}{r^2} \Delta_1^2\right) \left(1 + \frac{\alpha^2 L^2}{R^2}\right)} \right]$$

$\tan \varphi_4 =$

$$\frac{\frac{\alpha l}{r} (\Delta_1 - 1) + \frac{\alpha L}{R} \left(1 + \frac{\alpha l}{r} \Delta_1\right)}{\left(1 + \frac{\alpha^2 l^2}{r^2} \Delta_1^2\right) \left(1 + \frac{\alpha^2 L^2}{R^2}\right) \frac{\Delta_2}{\Delta_1 (\Delta_2 - 1)} + 1 + \frac{\alpha l}{r} \left[\frac{\alpha l}{r} \Delta_1 - \frac{\alpha L}{R} (\Delta_1 - 1) \right]}$$

To discuss these results, we must now note what values to give

to the time constants $\frac{l}{r}$ and $\frac{L}{R}$.

If we calculate the time constants for existing machines, we find that they have values between 0.2 for very small machines and 10 for very large ones.

But just here it is well to note that when the poles are massive, variations of the current of excitation induce Foucault currents in the mass which may have appreciable importance. Even when the poles are laminated, they are crossed by bolts or rivets which give rise to circulating currents. Finally, if there were no cur-

rents in the mass of the poles, there would be some in that of the yoke, which is very rarely laminated. We must, therefore, assure ourselves that these currents have no appreciable effect on the resistance and the self-induction of the magnet coils.

We will content ourselves with roughly calculating this influence in the case of a round massive pole, supposing the distribution of the flux to be uniform in the pole. Let a be the radius of this pole, of which we shall consider only one slice 1 cm in thickness in the direction of the lines of force.

Let us call: $\phi_1 (1 + \epsilon \sin. at)$ the value of the flux in this pole.

Let us decompose our slice into an infinite number of rings of radius x , and of width dx . The flux in one of these rings is:

$$\phi_1 \frac{x^2}{a^2} (1 + \epsilon \sin. a t)$$

and the e.m.f. induced:

$$10^{-8} \phi_1 a \epsilon \frac{x^2}{a^2} \cos. at$$

The resistance of one of these rings, by admitting 15.10^{-6} for the resistivity of the metal, is:

$$15.10^{-6} \cdot 2\pi x \frac{1}{dx}$$

And the current, in consequence, is:

$$di = \frac{10^{-8} \phi_1 a \epsilon x dx}{30 \cdot \pi \cdot a^2} \cos. a t$$

The total current in the pole is therefore:

$$\int_0^a di = \frac{\phi_1 a \epsilon}{19,000} \cos. a t,$$

And for the effective current: $\frac{\phi_1 a \epsilon}{27,000}$

Let us apply this formula to a pole having a radius of 10 cm ($a=10$), in which the normal induction is 14,000, whence $\phi_1 = 4,400,000$, by supposing that it varies 1 per cent because of the inductor current ($\epsilon = 0.01$) with the period of one second ($a = 6.28$). The current of circulation in the poles is then 10 amperes effective.

Now, in general, such a pole will carry from 400 to 500 ampere-turns per cm of length. The influence of the Foucault currents, due to oscillations of the order of a second, will then be negligible.

Without calculation, we may be sure that it is the same for the currents developed in the frame of the coils and for those developed in the armature if it is closed on anything.

Regarding the fact that the poles of alternators are never very large (excepting turbo-alternators), I think that we may consider in general:

$$\frac{l}{r} = 1, \text{ for the exciters,}$$

$$\frac{L}{R} = 1 \text{ to } 5, \text{ for the alternators.}$$

The application is then easy. In working it out we get a result which might be expected *a priori*; that is to say, the kinetic variation in the oscillatory output, which may be determined by the ratio $\frac{\epsilon_4}{\epsilon}$ differs very slightly from unity for the normal values of Δ_1 and Δ_2 and from the oscillations of which the period is of the order of a second. This is because, owing to the self-induction of the inductors of the exciter and of the alternator, the current of excitation of the alternator is appreciably constant. We must allow values of Δ_1 and Δ_2 high enough, so that ϵ_4 will be several times as large as ϵ . But this can still be produced in certain cases, particularly when Δ_2 is negative and when α is very small, that is to say, when the oscillations are very long.

We will see further on that the lag φ_4 is of great importance in certain cases. Its limits are 0 and $\frac{\pi}{2}$. When the conditions are normal, it is only from 20 deg. to 30 deg., but it may still quite easily reach 45 deg. ($\tan. \varphi_4 = 1$) and even exceed that value. In general it is as much greater as the ratio $\frac{\epsilon_4}{\epsilon}$ is itself greater.

To resume, the kinetic variation being in general equal to 1 with an oscillatory output, I would not have deemed it proper to develop this part if it had not a great bearing on what is to follow. Even if it reaches 2 or 3, this has only a secondary interest in the working of an isolated generator. On the other hand, φ_4 is of great importance, as we shall see when several generators are working in parallel.

WORKING IN PARALLEL.

The variation of voltage, due to a change of speed at steady output, has evidently only a moderate influence on the working in parallel of two generators. In the case of dynamos there results simply a difference in the current delivered by each machine; if it is a case of alternators, the result is simply an exchange of wattless current.

The variations having an oscillatory character act differently and may be harmful when the lag becomes important.

DYNAMOS.

Suppose two ordinary dynamos with shunt excitation coupled in parallel, at no-load to simplify matters, and oscillating around their average speed. Their speeds are:

$$\Omega_m (1 \pm \epsilon \sin. a t).$$

The sign + standing for the first machine, and the sign — for the second.

The e.m.fs. are:

$$E_1 (1 \pm \epsilon \sin. a t)$$

for the excitations, being directly in parallel, are equal, and are appreciably constant because of the self-induction of the field coils. Supposing ρ and λ the resistance (ρ is not the ohmic resistance, but a resistance calculated by taking into account the reaction of the armature).

The circulating current is therefore:

$$E_1 \epsilon \frac{\rho \sin. a t - a \lambda \cos. a t}{\rho^2 + a^2 \lambda^2}$$

and the power furnished by each machine, omitting negligible terms, is:

$$\pm E_1^2 \epsilon \frac{\rho \sin. a t - a \lambda \cos. a t}{\rho^2 + a^2 \lambda^2}$$

The couples due to the influence of the current of circulation are therefore:

$$\mp \frac{E_1^2 \epsilon}{\Omega_m} \frac{\rho \sin. a t - a \lambda \cos. a t}{\rho^2 + a^2 \lambda^2}$$

If we observe, then, that the advance of each machine with relation to the average position, otherwise called the angular distance, in the case of alternators, is of the form

$$\mp \frac{\Omega_m \epsilon}{a} \cos. a t,$$

we deduce easily that the couples in each machine are composed of one part

$$\pm \frac{E_1^2 \epsilon}{\Omega_m} \frac{a \lambda}{\rho^2 + a^2 \lambda^2} \cos. a t,$$

which corresponds to the elasticity, and of

$$\mp \frac{E_1^2 \epsilon}{\Omega_m} \frac{\rho}{\rho^2 + a^2 \lambda^2} \sin. a t,$$

which corresponds to the damping.

There is therefore in each machine a synchronizing couple, as in the alternators, which is due to the self-induction of the armature; and which is in value (quotient of the couple by the angle):

$$C_s = \frac{E_1^2 \alpha}{\Omega_m^2} \frac{a \lambda}{\rho^2 + a^2 \lambda^2}$$

Two ordinary dynamos coupled in parallel have therefore a characteristic period of oscillation, like two alternators, whose value is:

$$T = 2\pi \sqrt{\frac{J \Omega_m^2 \rho^2 + a^2 \lambda^2}{E_1^2 \alpha a \lambda}}$$

J being the moment of inertia.

But contrary to what occurs for the alternators, this characteristic period depends on the period of existing oscillations. If the existing oscillations are forced oscillations, the characteristic period is perfectly defined and connected with the period of forced

oscillations $\frac{2\pi}{a}$ by the above relation. There may be resonance if

$\frac{2\pi}{a} = T$. As for the free oscillations, they are determined by

$\frac{2\pi}{a} = T$, whence:

$$T = 2\pi \sqrt{\frac{\lambda^2}{J \Omega_m^2 - \rho^2}}$$

but these free oscillations are hardly ever visible, because the damping is very energetic, always more energetic than in the alternators. For the same reason, the forced oscillations are not very great when there is resonance; and I believe I can thus explain why these facts have never been brought into evidence experimentally.

The damping may, on the contrary, be very slight, even negative,

when the dynamos are furnished with special exciters like the alternators.

The e.m.fs. then become:

$$E_1 [1 \pm \epsilon_1 \sin. (a t - \varphi_1)]$$

which gives for the elastic couple:

$$\pm \frac{E_1^2 \epsilon_1}{\Omega_m} \frac{\rho \sin. \varphi_1 + a \lambda \cos. \varphi_1}{\rho^2 + a^2 \lambda^2} \cos. a t.$$

and for the damping couple:

$$\mp \frac{E_1^2 \epsilon_1}{\Omega_m} \frac{\rho \cos. \varphi_1 - a \lambda \sin. \varphi_1}{\rho^2 + a^2 \lambda^2} \sin. a t.$$

The elastic couple is not seriously modified, whereas the damping may become zero if $\frac{l}{a \lambda} = \tan. \varphi_1$, and even negative if $\frac{\rho}{a \lambda} < \tan. \varphi_1$. It is needless to say that in this case the working in parallel becomes altogether impossible. Without having any precise data, I believe that this case has already occurred. It is, however, very easy to remedy the situation by joining the exciters in parallel.

ALTERNATORS.

The question is more complicated and the calculations longer for alternators. The *amplitudes* of the e.m.f. are the same as in the preceding case, but the phases vary uniformly according to a sinusoidal law; so that the internal e.m.fs. are:

$$E_1 [1 \pm \epsilon_1 \sin. (a t - \varphi_1)] \sin. \omega \left(t \mp \frac{\epsilon}{a} \cos. a t \right).$$

ω being the normal or average pulsation of the alternating current. By leaving the alternators at no-load, and by noticing that $\omega \pm \epsilon$ differs very little from that value of ω , we may write, without serious error, for the circulating current between the two machines (neglecting the internal resistance ρ in comparison with the reactance $\omega \lambda$):

$$\frac{E_1}{\omega \lambda} \left[\frac{\omega \epsilon}{a} \cos. a t \sin. \omega t - \left(1 - \frac{\omega^2 \epsilon^2}{4 a^2} \cos. 2 a t \right) \epsilon_1 \sin. (a t - \varphi_1) \cos. \omega t \right]$$

The complete expression of the power is very complicated, but as we are able to omit all the terms of $2 \omega t$, which are without influence because of their great frequency, we find for the average power:

$$\left. \begin{matrix} P_1 \\ P_2 \end{matrix} \right\} = \pm \frac{E_1^2}{2 \omega \lambda} \left[\frac{\omega \epsilon}{a} \cos. a t \left(1 - \frac{\omega^2 \epsilon^2}{4 a^2} - \frac{\omega^2 \epsilon^2}{4 a^2} \cos. 2 a t \right) \left\{ 1 - \epsilon_1^2 \sin^2 (a t - \varphi_1) \right\} \right]$$

This expression is still too complicated for discussion. But a point not yet considered permits its simplification. As we know, the characteristic period of oscillation of the coupled alternators is:²

$$T = 2\pi \sqrt{\frac{20 \cdot \omega \cdot \lambda \cdot J \cdot \Omega_m}{p E_1^2}}$$

(p , number of pairs of poles).

If T is equal to, or greater than, $\frac{2\pi}{a}$, we may neglect terms like $2a$, $3a$, etc., which can only have a negligible influence, as they can not get into resonance.

We then have:

$$\left. \begin{matrix} P_1 \\ P_2 \end{matrix} \right\} = \pm \frac{E_1^2 \epsilon}{2 a \lambda} \left\{ \left[\left(1 - \frac{\epsilon_1^2}{2} \right) \left(1 - \frac{3}{8} \frac{\omega^2 \epsilon^2}{a^2} \right) + \left(1 - \frac{\omega^2 \epsilon^2}{2 a^2} \right) \frac{\epsilon_1^2}{4} \cos. 2 \varphi_1 \right] \cos. a t \right. \\ \left. + \left(1 - \frac{\omega^2 \epsilon^2}{2 a^2} \right) \frac{\epsilon_1^2}{4} \sin. 2 \varphi_1 \sin. a t \right\}.$$

Admitting provisionally that $\frac{\omega \epsilon}{a}$ is smaller than $\frac{1}{4}$, which supposes that $\frac{\epsilon \cdot 2\pi}{a} < \frac{1}{200}$, the formula is simplified and becomes:

$$\left. \begin{matrix} P_1 \\ P_2 \end{matrix} \right\} = \pm E_{ef} I_{oc} \frac{\omega \epsilon}{a} \left(\cos. a t + \frac{\epsilon_1^2}{4} \sin. 2 \varphi_1 \sin. a t \right)$$

E_{ef} , effective internal voltage.

I_{oc} , short-circuit current.

We therefore again have in this case an elastic couple:

$$\frac{E_{ef} I_{oc} \omega \epsilon}{\Omega_m a} \cos. a t$$

which is the ordinary synchronizing couple; and a couple:

$$\frac{E_{ef} I_{oc} \omega \epsilon}{\Omega_m a} \frac{\epsilon_1^2}{4} \sin. 2 \varphi_1 \sin. a t$$

which has the opposite sign to that of the damping.

Needless to say, this couple may be harmful and provoke an

2. See on this subject my other paper presented to the Congress on the coupling of alternators in parallel. Also; P. Boucherot, *Lumière Electrique*, Vol. XLV, August, 1892; *Bulletin de la Soc. Inter. des Electriciens*, November, 1901, and July, 1904.

oscillation which increases of itself, having for period the characteristic period T , if it is greater than the damping. For it is evidently necessary that ϵ and ϵ_4 should already have a certain value, but this occurs naturally at the moment of coupling, the two alternators never being exactly at the same speed; independent of the momentary perturbations which may have their origin in the machines which drive the alternators.

I think this explanation may be advanced concurrently with another³ for the phenomena of "Cumulative Surging," to which Mr. H. H. Barnes has recently called the attention of the American Institute of Electrical Engineers. There may also be other causes to seek.

As for direct-current dynamos, this theory indicates that it suffices to join their exciters in parallel to do away with the harmful effect, since in that case $\sin. 2 \varphi_4$ becomes zero.

We will not linger to discuss the results when $\frac{\omega \epsilon}{\alpha}$ is greater than $\frac{1}{4}$. Suffice it to say that owing to this, the characteristic period is increased and the negative damping may diminish.

3. See the author's paper to the Congress, entitled "The Influence of Hysteresis on the Working of Alternators in Parallel."

INFLUENCE OF HYSTERESIS ON THE WORKING OF ALTERNATORS IN PARALLEL.

BY M. PAUL BOUCHEROT.

In a communication made a few months ago to the American Institute of Engineers, Mr. H. H. Barnes called attention to a very curious fact which he named "Cumulative Surging," which is produced in certain cases with fly-wheel alternators coupled in parallel.

The governors of two generator units are suppressed by blocking them, so that the steam admission shall be constant. The units are brought to the same speed as nearly as possible and coupled. Then the machines, instead of coming into phase after a few oscillations, on the contrary oscillate, more and more, with their own characteristic period of oscillation T ; and the amplitude of these oscillations increases quite rapidly until uncoupling occurs. This phenomenon can not be attributed to resonance, for in the special cases where it was produced the characteristic period T was two or three times longer than the period of rotation. Neither can it be attributed to the speed governors, as these were suppressed. There appears to be therefore a cause of perturbations as yet unknown, when the two alternators are working in parallel.

I believe that two explanations of these facts may now be put forward. There may be at least two causes for perturbations: perhaps there are others.

In another communication to the Congress on "Kinetic Variation of E.M.F.," etc. (page 669) will be found a first explanation, which I will sum up here in a few words:

When an alternator has a periodic variation of speed, if it carries its own exciter, the latter being either placed at the end of the shaft or connected by belt or gear, the variations of voltage of the alternator lag a little behind the variations of speed. The lag, φ_4 , of the variations of voltage behind the variations of speed, which is always between 0 and $\frac{\pi}{2}$ may, without any very abnormal state

of affairs, be in the neighborhood of $\frac{\pi}{4}$. If then, two such alternators are run together in parallel, there is in each one, as a result of the oscillations of whatever kind, an amplifying couple opposite in sign to the damping couple, which has a value approaching:

$$\frac{E_{ef} I_{co}}{\Omega_m} \frac{\omega \varepsilon}{a} \frac{\varepsilon_4^2}{\pm} \sin 2 \varphi_4 \sin \alpha t,$$

when the speed of one of them is:

$$\Omega_m (1 + \varepsilon \sin \alpha t).$$

Where Ω_m = average angular speed.

ε = relative variation of this speed.

ε_4 = corresponding variation in the voltage.

a = pulsation of these variations.

ω = pulsation of current.

E_{ef} = mean effective voltage.

I_{co} = current of short-circuit corresponding to voltage E_{ef} .

This amplifying couple may sometimes be greater than the damping couple, and then the "cumulative surging" may manifest itself.

I will not proceed further, but refer the reader whom it interests to the paper cited above.

The other explanation of this phenomenon is based on the influence of hysteresis in the iron of the armatures of the alternators, and it is this that I intend to elucidate in what follows.

If we examine in detail what takes place in an alternator, we readily recognize that the e.m.f. lags slightly from the position it would have were there no hysteresis in the armature laminations. This is so self-evident as not to necessitate the offering of proof.

But an electrodynamic force results from the action of the armature current, *not* on the magnetic field of the armature but on the magnetic field of the field magnets; it is not on the armature iron, but on the field-pole iron that the armature currents exert their action. Thus the power is not exactly the product of the e.m.f. by the current, but the product of what would be the e.m.f. without the hysteresis lag, by the existing current.

Let us suppose the speed of the two coupled alternators with oscillatory output to be:

$$\Omega_m (1 \pm \varepsilon \sin \alpha t)$$

the sign + corresponding to one of the alternators, and the sign — to the other. As the angular distance is, at each instant (integrals of the velocities).

$$\mp \frac{\Omega_m \epsilon}{a} \cos a t,$$

the e.m.f. without hysteresis would be

$$E_1 [1 \pm \epsilon \sin a t] \sin \omega [t \mp \frac{\epsilon}{a} \cos a t]$$

which can also be written without great error:

$$E_1 [1 \pm \epsilon \sin a t] [\sin \omega t \mp \frac{\omega \epsilon}{a} \cos a t \cos \omega t]$$

Because of the hysteresis lag, we have in reality

$$E_1 [1 \pm \epsilon \sin a t] [\sin (\omega t - x) \mp \frac{\omega \epsilon}{a} \cos a t \cos (\omega t - x)].$$

Let us neglect temporarily the internal resistance ρ of the alternators; if λ is the self-induction of each, the circulating current becomes

$$\frac{E_1}{\omega \lambda} \left[\frac{\omega \epsilon}{a} \cos a t \sin (\omega t - x) + \epsilon \sin a t \cos (\omega t - x) \right]$$

According to the observation made above, the activities are the product of that current by the e.m.f. (without hysteresis). By discarding terms like $2 \omega t$, so as to retain only the average activities and by neglecting a few unimportant terms, we have:

$$\left. \begin{matrix} P_1 \\ P_2 \end{matrix} \right\} = \pm \frac{E_1^2}{2 \omega \lambda} \left[\frac{\omega \epsilon}{a} \cos x \cos a t + \epsilon \sin x \sin a t \right]$$

Now it is easy to see that $\sin x$ is just the ratio of hysteresis loss, η , in the armature, to the total power of the machine (0.02 to 0.06, according to circumstances). Hence, we may replace $\cos x$ by unity, and the activities become, more simply,

$$\left. \begin{matrix} P_1 \\ P_2 \end{matrix} \right\} = \pm E_{ef} I_{\infty} \left[\frac{\omega \epsilon}{a} \cos a t + \epsilon \eta \sin a t \right]$$

the first term of the second member.

$$E_{ef} I_{\infty} \frac{\omega \epsilon}{a} \cos a t$$

is the synchronising power which furnishes the elastic couple and the characteristic period of oscillation; the second term divided by the average speed Ω_m ,

$$\frac{E_{ef} I_{\infty}}{\Omega_m} \epsilon \eta \sin a t,$$

is a perturbing couple of opposite sign to the damping couple, which exaggerates the oscillations indefinitely when it is greater than the damping.

The damping C_a may be defined by the equation,

$$\text{damping couple} = C_a \frac{\Omega - \Omega_m}{\Omega_m}$$

where Ω is the instantaneous velocity, $\Omega_m (1 \pm \epsilon \sin \alpha t)$ in this case. The damping couple is therefore

$$\mp C_a \epsilon \sin \alpha t$$

and the "cumulative surging" may appear when

$$\frac{E_c g I_{cs}}{\Omega_m} \eta > C_a$$

In general, C_a is a fraction, $\frac{1}{g}$, of the normal couple under load of the alternator; if, on the other hand, we call k the ratio of the short-circuit current, I_{cs} , to the normal current, the inequality above becomes

$$k \eta g > 1.$$

In alternators with laminated poles, g is very great, 10 or perhaps more. We see then that in general, for $k=4$ (alternators with small reaction), $\eta=0.09$, and $g=10$:

$$k \eta g = 2,$$

and the phenomenon is produced. It is produced the more easily because the reaction is small, the loss by hysteresis great and the damping weak.

In all this, the excitation of the alternators is supposed to be absolutely constant, furnished, for example, by storage batteries. When the alternators have exciters, the influence which we mentioned at the start is added to that of the hysteresis; it is as much greater as the reaction is less, and in addition, since it contains α in the denominator, it is as much greater as the fly-wheel is heavier. This may account for the phenomenon having been especially noticed with heavy fly-wheels. It disappears as soon as the exciters are connected in parallel; in fact, this has a double result, namely—

1). That of annulling φ_s and of suppressing, in consequence, the first effect.

2). That of introducing an extra damping by the exchange of current between the exciters.

Mr. Barnes has also observed that the balancing is suppressed when (the alternators being excited by accumulators) the exciters have their armature circuits closed upon resistances. This is still another increase of damping since in that case the resisting

couple of the exciters is proportional to the speed. And we need not be surprised that so slight a cause should have such an effect, for the perturbing couple due to hysteresis is small, since it contains $\gamma \epsilon$; it is of the same order of magnitude as the damping when this is very weak. The cumulative surging does not appear when the damping is somewhat vigorous.

This influence of hysteresis can be very easily explained physically.

When two coupled alternators are not running quite together and do not oscillate, if the e.m.fs. are equal, the circulating current is an energy current. If they oscillate, the periodic difference of their e.m.fs. gives rise to a small supplementary current of circulation, which is wattless, periodic, maximum in the middle of the oscillation and zero at the extremes. Without hysteresis this wattless current has no effect. With hysteresis it is slightly retarded and so becomes partially an energy current (negative), its energy component is the moving power, and as it is maximum in the midst of the oscillation, that is to say, when the periodic velocity is maxima it produces a negative damping.

The lag of the e.m.f. with respect to speed, when there are exciters, produces the same result.

We may thus predict that any cause due to the oscillation of the e.m.f., which makes the small wattless current lag, will produce the same effect.

On the other hand, any cause which occasions a lead will oppose the appearance of the phenomenon. One such cause is the internal resistance of the alternators which, like all resistance, has for an effect to provoke an advance of the current when it is introduced into a reacting circuit. If we return to the preceding calculations, but do not omit ρ with respect to $\omega \lambda$, while still neglecting ρ^2 in comparison with $\omega^2 \lambda^2$ for simplicity, we find for the perturbing couple,

$$\frac{E_{\text{ex}} I_{\infty}}{\Omega_m} \epsilon \left(\eta - \frac{\rho}{\omega \lambda} \right) \sin \alpha t.$$

The perturbing couple, due to hysteresis alone, can become zero, or even have a damping effect, by augmenting the internal resistance ρ .

It would be interesting to verify this prediction experimentally.

COUPLING FLY-WHEEL ALTERNATORS IN PARALLEL.

BY M. PAUL BOUCHEROT.

It is not intended to repeat here what is today pretty well known to all competent electricians. It is merely desired to offer an opinion on the question as to the fly-wheel which should be employed with alternators directly coupled to reciprocating steam engines. This is ventured the more readily because the opinion held by the writer agrees, with some qualification, fairly well with that expressed some time ago by Mr. H. H. Barnes in a paper presented before the American Institute of Electrical Engineers.

It is well recognized today that there is a lower limit imposed to the size of a fly-wheel on account of the necessity of avoiding electro-mechanical resonance, or to be more exact, the very great increase of angular deviation which develops in steam engines when in the immediate vicinity of resonance. But what is the exact deviation from it which may be permitted? What certainty will there be, in applying the formulas, whether we are sufficiently close to it? On the other hand, the unavoidable presence of a governor on a steam engine seems to fix an upper limit to the size of the fly-wheel. What is this upper limit? Are there other circumstances which make it desirable that we should exceed these limits or which permit that we should remain within them? This is the question we shall endeavor to solve.

MINIMUM FLY-WHEEL

To avoid resonance, it is evidently necessary to first know exactly the period of natural oscillation.

The well-known formula for the period of oscillation for two identical alternators coupled in parallel, which is also that of the period of an alternator on open circuit, is, for any given load¹,

1. P. Boucherot, *Lumière Electrique*, Vol. XLV, August, 1892.

$$T = 2 \pi \sqrt{\frac{10 \cdot J \cdot \Omega_m}{p E^2 D}}$$

where

$$2 D = \frac{\omega l}{r^2 + \omega^2 l^2} - \frac{\omega (l + 2 L)}{(r + 2 R)^2 + \omega^2 (l + 2 L)^2}$$

J = moment of inertia; p = number of pairs of poles;
 Ω_m = average angular speed; E = internal maximum e.m.f.;
 ω = pulsation of current; r = resistance of alternator; l = self-induction of an alternator; R = resistance of the external circuit; L = self-induction of the external circuit.

When the alternators are without load ($L = 0$, $R = \infty$), if r^2 be neglected in comparison with $\omega^2 l^2$, which is certainly justifiable, the formula is simplified, replacing $\frac{E}{\sqrt{2} \omega l}$ by I_{sc} (current of short-circuit),² and becomes,

$$T = 2 \pi \sqrt{\frac{10 \cdot J \cdot \Omega_m}{p E_{sc} I_{sc}}}$$

which can also be written:

$$T = 2 \pi \sqrt{\frac{P R_g^2 \Omega_m}{p k P_n}}$$

in which P = weight of the revolving part; R_g = radius of gyration; k = ratio of the current of short-circuit to the normal current; P_n = normal output of the alternator.

Experience has demonstrated that this formula is exact to the same degree of accuracy as are most industrial formulas, that is to say within 3 to 5 per cent. A considerable number of verifications have been made of it in various quarters.

I had it verified on alternators with belts in the following manner: The two alternators were each run by a very small direct-current motor, and by means of very small belts, so that the elasticity and inertia introduced by this means into the system were nearly negligible in presence of the elasticity and inertia of the alternators, a condition which is readily fulfilled. The alternators were so placed that their shaft axes were in line and their relative movements were observed stroboscopically. The alternators

². See also A. Blondel, *Bulletin de la Soc. Int. des Électriciens*, Jany, 1893.

were electrically coupled before they were completely in phase, so that some ten or twenty oscillations were produced before there was complete concordance, a condition which would make it possible to measure their period of oscillation.

Mr. H. H. Barnes has also made a large number of verifications on fly-wheel alternators by counting the oscillations of the measuring instruments, oscillations which were excited by suppressing the dash-pots of the governors on the steam engines. In twelve instances where these measures were taken, the average error was 3 per cent (observed period less than calculated period).

Lastly, some cases of resonance made it possible to still further note the accuracy of this calculation.

It must moreover be remarked that in this formula the calculation of P and of R_g —more simply of the moment of inertia—can not be made easily because of the complicated form of the parts, the consequence being that one can not count more than 3 to 5 per cent of an approximation. This is sufficient from the industrial standpoint.

It is advisable, nevertheless, to state precisely what is understood by the short-circuit current I_{sc} in the formula of T .

When it is a question of a non-saturated alternator, working on the straight part of the characteristic, the definition is very simple; it is the short-circuit current obtained with the excitation which gives E_{sc} at no-load, being careful to multiply by 2 if the alternator is two-phase, and by $\sqrt{3}$ if it is three-phase.

When the alternator is saturated, common sense and experience indicate that something else must be taken into consideration. For instance, the figure represents the characteristics at open-circuit and with short-circuit; for I_{sc} we must not take OC , corresponding to the working-point A , but OD , corresponding to the point B , taken on the rectilinear prolongation of the straight part of the open-circuit characteristic.

The actual period being known *a priori* with sufficient precision, it is necessary to arrange that it shall differ from the period of forced oscillations. But many engineers imagine that the period of forced oscillations is that of the piston stroke. This may lead to error. The period of forced oscillations which must be particularly avoided, and which calls for the minimum fly-wheel, is that of *rotation*, or of one revolution of the steam engine.

In the *Bulletin de la Société Internationale des Électriciens*, November, 1901, the result is given of analyses which I made at that time on twenty-eight diagrams of turning couples of steam engines, which were furnished me by various French builders. According to these analyses, the Fourier series, representing the

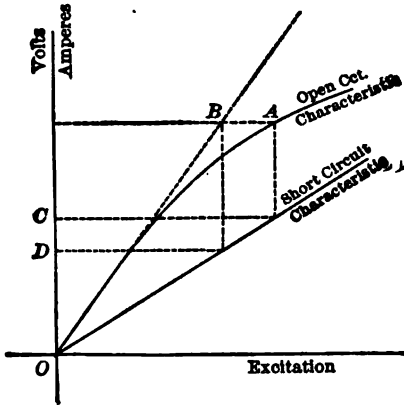

FIG. 1.—NO-LOAD AND SHORT-CIRCUIT CHARACTERISTICS.

turning couple of a steam engine, must have as its fundamental term a term whose frequency is the frequency of rotation. These analyses may thus be summarized:

For a monocylinder machine, the series contains the average couple C_m plus harmonic terms having as coefficients the following approximate values:

The term.	At half-load.	At full-load.
$\Omega_m t$	$0.12 C_m$	$0.16 C_m$
$2 \Omega_m t$	$0.9 C_m$	$0.9 C_m$
$3 \Omega_m t$	$0.12 C_m$	$9.11 C_m$
$4 \Omega_m t$	$0.4 C_m$	$0.11 C_m$

For a multicylinder machine, the series approximately contains the average couple C_m , plus—

The term.	At half-load.	At full-load.
$\Omega_m t$	$0.1 C_m$	$0.1 C_m$
$2 \Omega_m t$	$0.5 C_m$	$0.2 C_m$
$3 \Omega_m t$	$0.35 C_m$	$0.15 C_m$
$4 \Omega_m t$	$0.4 C_m$	$0.4 C_m$

plus other less important terms in 5, 6, 7, etc., $\Omega_m t$.

In all these series, the uneven terms ($\Omega_m t$, $3 \Omega_m t$, etc.), are due to the obliquity of the connecting rod to the piston rods. Owing to this fact, the turning couple in one half turn is not symmetrical with the turning couple in the other half turn. A partial compensation for this lack of symmetry may be obtained by means of masses fixed in the fly-wheel, which serve to balance the revolving system. This has sometimes been successfully accomplished, but the artifice must not be counted on to suppress the term $\Omega_m t$. The compensation in question can only be obtained for one value of the load and, moreover, one must always allow for a small difference between the front and back admissions, however well regulated the distribution may be.

A very easy experiment which any one can try in any central station when there are two identical alternators having their shafts in line, proves at once the predominance of the term $\Omega_m t$, which, although small in the expression of the turning couple, gives rise to a marked forced oscillation, because, other things being equal, it would give an angular distance four times greater than the term $2 \Omega_m t$, nine times greater than that of $3 \Omega_m t$, etc. When looking at one of the machines through the other, one notes that slightly preceding the coupling in parallel, the movement of the image is continuous, with the superposition of a slight oscillation of the same frequency as the rotation. As soon as in step, the continuous movement ceases and the oscillation continues with a certain increase, a fact well explained by the formulas.

It is therefore the term of period $\tau = \frac{2\pi}{\Omega_m}$ which must, above all, be avoided. Moreover, it must be avoided by making $T > \tau$. By making $T < \tau$, there is risk of getting $T = \frac{\tau}{2}$, and of having a resonance for the second term, due to the piston stroke. T being variable with the load and with the voltage, transient variations of load, or of excitation, would cause falling out of step.

By how much then must T exceed τ ?

To determine this a few formulas must be called to mind:

Let us suppose that only one of the terms of the Fourier series representing the turning couple exists with the average couple. The turning couple will be:

$$C_m - C_o \cos (n \Omega_m t).$$

By calling C_o the elastic couple due to the simultaneous reactions,

$C_s = \frac{p E_{cs} I_{cs}}{\Omega_m}$ and Ω the instantaneous speed, the couple due to the synchronous currents is at each instant:

$$C_s \int (\Omega - \Omega_m) dt.$$

The couple due to the damping will be:

$$C_a \frac{(\Omega - \Omega_m)}{\Omega_m}$$

and that due to inertia:

$$J \frac{d\Omega}{dt}$$

Assuming the sum of these couples to be zero, we deduce the angular velocity, and then the angular deviation θ_s of an alternator connected to the circuit:

$$\theta_s = \frac{C_s}{\sqrt{n^2 C_a^2 + (n^2 J \Omega_m^2 - C_s)^2}}$$

which, for an alternator not in circuit ($C_s = 0$, $C_a = 0$), becomes:

$$\theta = \frac{C_s}{n^2 J \Omega_m^2}$$

If we call σ the ratio $\frac{\theta_s}{\theta}$ or, in other words, the *increase* of the angular deviation, due to the coupling,

$$\sigma = \frac{n^2 J \Omega_m^2}{\sqrt{n^2 C_a^2 + (n^2 J \Omega_m^2 - C_s)^2}}$$

When the damping is great, this formula remains always rather complex, but it is best, for security, to assume that the damping is zero ($C_a = 0$) and σ then becomes very simple:

$$\sigma = \frac{W}{W - W_2}$$

in which W is the energy stored in the fly-wheel, $W = \frac{1}{2} J \Omega_m^2$ and W_2 that which would be stored if there were perfect resonance:

$$W_2 = \frac{p \cdot E_{cs} \cdot I_{cs}}{2 n^2 \Omega_m} = \frac{C_s}{2 n^2}$$

which depends on n .

For $n = 1$, W_2 becomes $\frac{p \cdot E_{cs} \cdot I_{cs}}{2 \Omega_m}$, and I call this size *the fly-wheel of resonance*.

With a fly-wheel having double the inertia of the fly-wheel of resonance, the increase σ for the fundamental term is equal to 2. The increase for the other terms is then without importance; it is 1.14 for the second term, 1.06 for the third, etc.; we then have $T = \sqrt{2} \tau$. We shall see then what are, for steam engines in about normal condition, the angular deviations θ and θ_0 when $W = 2W_2$.

And first, what is the limit which must be assigned to the deviation θ_0 ? In serviceable operation in parallel, it does not suffice to avoid getting out of step; it is also necessary that the periodic pulsations of voltage, due to the periodic variation of the couples, shall be inappreciable.

Now, if we refer to the formula for voltage at the terminals of two alternators in parallel,³

$$e_{\sigma} = E \sqrt{\frac{R^2 + \omega^2 L^2}{(r + 2R)^2 + \omega^2 (l + 2L)^2}} (1 + \cos 2\theta_0)$$

we see that for $\theta_0 = 10$ deg., the voltage varies 1.5 per cent, which is allowable, even for pulsations, but it constitutes a limit. A variation of 6 per cent, corresponding to $\theta_0 = 20$ deg., would certainly not be permissible.

If $W = 2W_2$, we have for each of the terms of the Fourier series,

$$\theta = \frac{C_0}{n^2 J \Omega_m^2} = \frac{C_0 \Omega_m}{2 n^2 p E_{\sigma} I_{\sigma}}$$

from whence results the deviation in the period:

$$p \theta = \frac{C_0}{C_n} \frac{1}{2 n^2 k}$$

C_n being the average coupling at full-load, and k the ratio of the current of short-circuit to the normal current. In the most unfavorable case, $k = 1$; by admitting certain extreme values for the C_0 of the different terms, we may establish the following table of corresponding distances:

n	C_0	$p \theta$	σ	$\sigma p \theta$
1	0.15 C_n	0.075	2	0.15 or 8.6
2	C_n	0.125	1.14	0.143 or 8.2
3	0.19 C_n	0.008	1.06	0.008 or 0.5
4	0.2 C_n	0.006	1.03	0.006 or 0.5

If all the terms were of such phase that all the maxima coincided at the same time, the total distance would be about 18 deg.; but,

3. P. Boucherot, *Lumière Electrique*, Aug. 6, 1892.

since this is not the case, the deviation is only from 10 to 12 deg. Therefore, under the most unfavorable conditions, a fly-wheel equal to twice the fly-wheel of resonance gives an angle a little too great, but almost permissible. Under the most favorable conditions $k=4$, and with multicylinder machines the angular deviation will be very slight and will be reduced to about 2 or 3 deg. in the period.

INFLUENCE OF THE LOAD.

Hitherto we have only considered the alternator without load, yet the influence of the load is far from always being negligible, as we shall presently see.

The usual formula for T is as follows:

$$T = 2\pi \sqrt{\frac{10 \cdot J \cdot \Omega_m}{p E^2 D}}$$

If a constant excitation were maintained, T would vary only with D , and it would readily be seen that T would increase with the load, whatever it might be. But these are not the actual conditions in practice. In reality, we vary the excitation with the load so as to maintain the potential difference at the terminals constant; so that it is necessary to consider the product $E^2 D$ and its variations. By omitting r in comparison with ωl , we may write:

$$E^2 D = \frac{e^2}{4 \omega l} \frac{2 R^2 + \omega^2 L (l + 2 L)}{R^2 + \omega^2 L^2}$$

and under these circumstances we have:

$$\text{without load, } R = \infty, L = 0, E^2 D = \frac{e^2}{2 \omega l}$$

$$\text{on watt load, } L = 0, E^2 D = \frac{e^2}{2 \omega l}$$

$$\text{on wattless load, } R = 0, E^2 D = \frac{e^2}{4 \omega l} \left(2 + \frac{l}{L} \right)$$

That is to say, T does not vary with the watt load, but *diminishes* with the wattless load.

What is the order of increase in this diminution?

For an alternator with a weak reaction ($k=4$), $\frac{l}{L}$ is at the most equal to $\frac{1}{2}$; T only diminishes 10 per cent ($0.89 T$). For an alternator with a strong reaction ($k=1$), $\frac{l}{L}$ is at most equal to 2; T diminishes 29 per cent, $\left(\frac{T}{\sqrt{2}} \right)$.

The influence of the load has been demonstrated in two or three cases which have come to my knowledge.

In a central station *A* the ratio $\frac{T}{\tau}$ calculated for no-load is 1.34. As a rule, the machines work fairly well in parallel; but it was ascertained, on two different occasions, that if under load, as a result of bad management, the excitations get too much forced, uncoupling becomes imminent and manifestly due to the increase of the forced oscillations. Under such conditions, the ratio $\frac{T}{\tau}$ calculated for full *wattless* output, reduces to 1.07.

On another central station *B* the ratio $\frac{T}{\tau}$, calculated for no-load, for machines installed some time and working well, is 1.56 ($W = 2.5 W_2$). A newly installed group, having $\frac{T}{\tau} = 2.4$ for no-load, works well for no-load, but badly with load. Finally, two new groups having $\frac{T}{\tau} = 1.13$ for no-load, can neither work together, nor with the others.

A fly-wheel $W = 2W_2$, $\left(\frac{T}{\tau} = 1.414\right)$ is, therefore, still a little inadequate for operation with load, when $\cos \varphi$ is not equal to 1, which is, at present, the general case. As $\cos \varphi$ is commonly 0.8, and as it may sometimes be even less than this value, it is best to discuss the case as if all the current were wattless.

In that case, if we wish to keep to σ for the fundamental term, the value 2 at full-load, we must allow for a fly-wheel $2\frac{1}{2}$ times the fly-wheel of resonance $\frac{W_2}{(0.8^2)^2}$, for alternators with weak reaction ($k=4$), and four times the fly-wheel of resonance, $\frac{W_2}{(\sqrt{2})^2}$ for alternators with strong reaction ($k=1$); but it is evident that in the latter case, as the deviation of the isolated group is very slight on account of the heavy fly-wheel, we may allow for σ a slight increase in value, since it is not σ which is important in itself, but $\sigma p \theta$.

It behoves us then to inquire what ratio, a , between the accepted fly-wheel and the fly-wheel of resonance, gives for $\sigma p \theta$, corresponding to the first term, a constant value, independent of k .

This is simple, and we readily find:

For $\sigma p \theta = 0.15$ or $8.^\circ 6$ at full-load (1st Fourier term):

k	a	σ at no-load	σ loaded
4	1.5	4.5	6
1	3	1.5	3

For $\sigma p \theta = 0.075$ or $4.^\circ 3$ at full-load:

k	a	σ at no-load	σ loaded.
4	1.75	2.33	3.5
1	4	1.33	2

To sum up, we must allow for the lower limit of fly-wheel from 1.5 to 2 times the fly-wheel of resonance ($T = 1.23$ to 1.41τ) for alternators having a very weak reaction; and from 3 to 4 times the fly-wheel of resonance ($T = 1.73$ to 2τ) for alternators having a very strong reaction—the fly-wheel of resonance being calculated for *no-load*, according to the formula:

$$W_s = \frac{p E_c \sigma I_a}{2 \omega_m}$$

TRANSITORY PERTURBATIONS.

In a steam engine, however well made, there may occasionally occur slight differences between the power developed by one steam-cylinder and that developed by those adjoining. It is evident that such a transitory difference only produces a deviation (followed by a few oscillations, free and damped), but it is also necessary that this deviation should be small, at the most only a few degrees in the period. We shall see what difference may perhaps be allowed transitorily with the double of the fly-wheel of resonance.

To simplify, we suppose that the forced oscillation does not exist, so as not to be obliged to take into account the precise moment when the new supplementary energy W_s is introduced into the system, and the damping is zero. We thus obtain for the elongation Ω_m a somewhat excessive value.

If the alternator oscillates freely, after introducing W_s its velocity is

$$\Omega_m (1 + \epsilon \sin \alpha t),$$

with $\alpha = \frac{2\pi}{T} = \sqrt{\frac{C_s}{J}}$

Each time it recrosses the medium position, its velocity is,

$$\Omega_{max} = \Omega_m (1 + \epsilon)$$

$$\text{hence, } W_c = \frac{J}{2} (\Omega_{max}^2 - \Omega_m^2);$$

whence, if we omit ϵ^2 with respect to ϵ

$$\epsilon = \frac{W_c}{J \Omega_m^2}$$

and finally:

$$\theta_m = \int_0^{\pi} (\Omega - \Omega_m) dt = \frac{\Omega_m \epsilon}{\alpha} = \frac{W_c}{\sqrt{2} W C_s} = \frac{W_c}{2 \sqrt{W W_c}}$$

The power of the cylinder is $C_n \pi$; if, momentarily, it is augmented by $m C_n \pi = W_c$; and if $W = 2 W_c$, there results:

$$p \theta_m = \frac{m \pi}{\sqrt{2}} \frac{1}{k}.$$

For $p \theta_m = 0.18$ (10 deg. in the period), and $k = 1$, the most unfavorable condition, we obtain $m = 0.08$; it is necessary that at full-load one cylinder should exceed the others by 8 per cent if the displacement is to be 10 deg. From this point of view, such a fly-wheel is sufficient.

COMPOUND ALTERNATORS.

If we study the action in parallel of compound alternators, the question is, at first view, more complex than for simple alternators.

At no-load, for example, while the power for two simple alternators is:

$$\left. \begin{matrix} P_1 \\ P_2 \end{matrix} \right\} = \pm \frac{E_{af}^2}{\omega l} \sin 2 \theta,$$

for two compound alternators, we have:

$$\left. \begin{matrix} P_1 \\ P_2 \end{matrix} \right\} = \pm \frac{4 e_{af}^2 \sin \theta_1 \sin \theta_2}{\omega l \sin (\theta_1 + \theta_2)}$$

which is indeterminate, as we do not succeed in eliminating θ_1 or θ_2 . This is explained by the fact that the exchange of wattless current between two machines is *indeterminate*, the voltages at the terminals of each being always maintained constant, whatever the output.

To remove this indetermination, another condition must be added; for example, that the internal e.m.f. should be maintained constant; and from this there results, $E_1 = E_2$, and $\theta_1 = \theta_2$:

$$\left. \begin{matrix} P_1 \\ P_2 \end{matrix} \right\} = \pm \frac{2 e_{af}^2}{\omega l} \tan \theta.$$

Two conclusions follow from this result:

1). The tangent at the origin, for $\theta = 0$, is the same as for the ordinary alternators; consequently, the period of natural oscillation is the same, whether the alternators are compounded or not.

2). Compound alternators are in stable coupling, since the tangent is infinite for $\theta = \frac{\pi}{2}$, if the steps taken to assure the equality of E_1 and E_2 do not modify the above equations.

This may be done in certain cases, but even when the steps taken modify the conditions in such a way that the alternators act toward each other like ordinary uncompounded alternators, there still remains in favor of the compound machine a marked advantage, namely:

A compound alternator may be produced with a much greater reaction than an ordinary alternator, since, in the latter, the reaction is limited by the drop of voltage admissible in practice, with the result that the fly-wheel of resonance is much smaller for it than for an ordinary alternator—in general, four times smaller ($k=1$) than for an alternator with a small drop of potential ($k=6$). The minimum fly-wheel allowable is not four times smaller, because, as we have seen, α must be about two times larger for a strong reaction ($k=1$) than for a weak reaction ($k=4$); but in the end it still remains about two times smaller.⁴

MAXIMUM FLY-WHEEL.

There seems to be advantage, from the point of view of general working, in not adopting very heavy fly-wheels. But although the minimum value of a fly-wheel may be fixed with relative precision, it does not seem possible, as yet, to fix, even approximately, the maximum value.

On the side of the lower limit the danger appears almost unexpectedly and sharply, but it is inexcusable; on the side of the upper limit it appears only little by little, and fortunately with much less serious consequences, for the reason that parallel operation simply deteriorates gradually. Most fortunately, also, the heavy fly-wheel is expensive and very naturally the tendency is not to exaggerate it.

The trouble caused by heavy fly-wheels is, as we know, especially

4. For a more detailed account, see "Quelques Applications d'Alternateurs Compounds," *Bulletin de la Soc. Int. des Électriciens*, June, 1902.

aggravated by speed governors. I can not do better than refer the reader on this subject to Mr. H. H. Barnes' paper, already cited. In particular, a comparison is therein given between three installations in which the engines and the alternators are the same and only differ in size of fly-wheels. The fly-wheels are respectively three, four and six times the fly-wheel of resonance—notwithstanding that the alternators have a small reaction—that is to say, the fly-wheels are very heavy. In the first central station parallel operation was satisfactory with a moderate damping of the governors; in the second, strong damping was required, and in the third, it was impossible to operate, whatever the amount of damping, without modifying the alternators. The “cumulative surging” occurred even without speed governors, which is, to say the least, singular. In two other papers submitted to the Congress, I have suggested two explanations of the occurrence. It may be attributed, in the first place, to the hysteresis of the armatures of the alternators; but if the perturbing couples which are brought into play through this influence are independent of inertia,⁵ they belong, however, to the number of those due to another cause; the lag of the variations of the internal e.m.fs. on the variations of speed⁶ depending on inertia.

Be this as it may, it appears well established that the longer the natural period of oscillation is, the more easily will oscillation be produced and the more necessary will it be to dampen the governors powerfully. For this reason it is, if anything, harmful to use three or four times the fly-wheel of resonance. As, on the contrary, there is no object in adding weight, it is better to stick to the lower limits determined above, and even, for the sake of precaution, to be a little below them.

FACILITY OF COUPLING.

It may also be interesting to note that in augmenting the fly-wheel we increase the difficulties of working in parallel. For example, with an infinite fly-wheel it would be impossible to couple, however small might be the difference in speed at the moment of the operation.

5. See “The Influence of Hysteresis on the Working of Alternators in Parallel,” page 687.

6. See “The Kinetic Variation of Electromotive Force in Dynamo-Electric Generators,” etc., page 669.

Let us seek what is the maximum angular deviation obtained with four times the fly-wheel of resonance under normal working conditions. At least five seconds are required between two successive identical states of the synchronising lamps before the risk can be taken of closing the switches; it is difficult to obtain more than ten seconds, on account of oscillation in speed, so easily produced in a machine at no-load. Let us assume 10 seconds: This means that one of the machines makes 501 revolutions while the other, already connected to the circuit, makes 500. The *vis viva* of the machines to be coupled is therefore $\frac{2}{500}$ greater than it should be, and the result is as if, the machines being coupled, we had introduced an external energy:

$$W_e = \frac{2}{500} W$$

From this results, either

$$\theta_m = \frac{1}{500} \sqrt{\frac{W}{W_s}}$$

or, with $W = 4 W_s$, $\theta_m = \frac{2}{500}$, that is to say, 0.23 deg. in the space. This time the difficulty grows with the number of poles, for eighty poles, $p = 40$, $p \theta_m$ equals from 9 to 10 deg. in the period, which is still reasonable. But, if we consider that the switches are not always closed at exactly the right moment, we see that the operation is difficult and may fail with heavier fly-wheels and an interval of only five seconds between the two successively identical states of the lamps of synchronisation; that is to say, in a moment of haste.

CHAIRMAN RUSHMORE: The papers of M. Boucherot are now open for discussion. If there is no discussion, we will proceed to the paper on "Leakage Reactance of Induction Motors," by Prof. C. A. Adams.

THE LEAKAGE REACTANCE OF INDUCTION MOTORS.

BY PROF. C. A. ADAMS, *Harvard University.*

The experiments, the results of which are here given, form part of a series planned by the writer about five years ago, but postponed from time to time.

The object of the series was to separate and measure the several elements of magnetic leakage in alternating-current machinery, to determine the factors upon which each of these elements depends, and to see how far fundamental principles could be applied effectively in predetermining leakage reactance.¹

Thus far the work has been confined to induction motors, and even in this field much of the material at hand could not be incorporated in the present paper owing to the lateness of the date at which the work was undertaken.

THEORY.

In the predetermination of induction motor leakage three elements are commonly considered; the *slot* or "peripheral" leakage; the *coil end* or "flank" leakage; and the *tooth-tip* leakage, recently presented by Mr. Behn Eschenberg under the head of the "winding coefficient."

At the commencement of the tests to be described below, a fourth element was discovered, which while not of much importance in machines of high frequency, plays a considerable part in machines of low frequency, especially in connection with the interpretation of the familiar short-circuit tests. This fourth element will hereafter be referred to as *belt leakage*, and will be described in turn.

As most of the reluctance of the leakage paths is due to non-magnetic material, it is customary to assume this reluctance to be

1. Some writers treat this subject under the head of the "Leakage Factor," σ . In the experiments here described measurements were made of the leakage reactance, x , and of the exciting reactance, x_0 . The approximate relation between these quantities is: $\sigma = x + x_0$.

constant and to calculate the leakage fluxes as if they had an independent existence, whereas in most cases they are merely distortions of the main flux.

Slot Leakage.

This relates to the flux which crosses the slots without crossing the gap, and there are two methods of calculation; one in which the leakage around each slot is assumed to be independent of the other slots, and the other in which each phase belt of current is supposed to have a leakage flux which links with all the current and crosses all the slots in that belt. The result of the calculation is evidently the same in either case since the reluctance of the leakage path in the second case is increased in the same proportion as the m.m.f.

The second method if carried to its logical conclusion would involve a leakage path linked with all the current under one pole and on one side of the air-gap. This would obviously reduce the resulting reactance owing to the difference of phase between the several current belts with which this flux would be linked. Moreover when it is remembered that the slot leakage is merely a distortion of the main flux, it will be evident that although the magnetizing effect of the current in a given slot may be felt at a considerable distance on either side of that slot, this effect ceases to be distortional at a very short distance.

As further proof on this point the writer carried out a series of experiments (not recounted below), in which careful measurement was unable to detect any mutual leakage reactance between adjacent slots.

As a basis for the calculation of the slot reactance by the method first mentioned above, the writer uses the familiar formula for the flux per slot ampere per cm length of slot (see Fig. 1).

$$\varphi_s = 1.96 \left(\frac{a}{3b} + \frac{a'}{b} + \frac{a''}{b'} + \frac{a'''}{b'''} \right) \dots \dots \dots (1)$$

For other shapes of slot or arrangements of conductors, obvious changes in this formula may be made.

The slot reactance is then

$$x_s = 2 \pi n \varphi_s N_s^2 l_s \frac{N}{N_s} 10^{-8} = 2 \pi n \varphi_s N_s l_s 10^{-8} \dots \dots (2)$$

where n is the frequency,

l_s

N_s the number of conductors per slot,
 l_s the length of the armature core in cms,
 N the number of active conductors per phase,
 and l_a the length of active conductor per phase in cms.

Assume an open slot of fixed depth, with a winding of fixed depth, and a fixed ratio of slot width to tooth pitch; then imagine the number of slots reduced to one-half; ϕ_s will be reduced to one-half, but the conductors per slot will be doubled; therefore, the total flux linkage per conductor ampere will remain the same. The

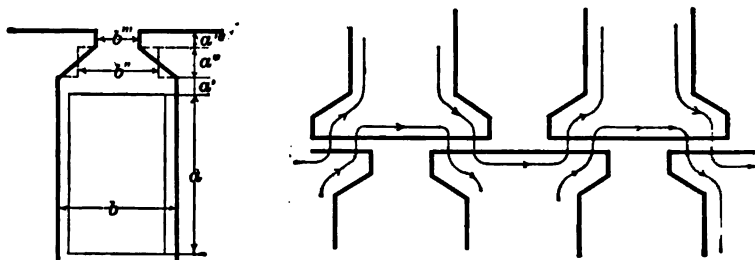

FIGS. 1 AND 2.

same conclusion holds for partly closed slots, provided the ratio of slot opening to slot width remains constant.

Thus the slot reactance is in many cases independent of the number of slots, but proportional to the slot depth, and otherwise dependent upon the location of the conductors and the overhang of the teeth. It is also independent of the air-gap.

Coil End Leakage.

The leakage around the coil ends is the most difficult element to calculate *a priori*, and various degrees of approximation are employed. The experimental results of the present investigation which bear upon this point must be reserved for another time, but enough of these results have been worked up to warrant the suggestion of the following mode of procedure, which is based on fundamental principles. This method is only a slight modification of that used by Niethammer.

Given a circular coil, in air, with a rectangular section whose long side is not more than twice its short side and whose diagonal is not more than one-tenth of the diameter of the coil. Its inductance (within 1 per cent) may be reduced to the following

convenient form; the flux per coil-ampere per cm length of coil is:

$$\varphi_r = 0.2 \log_{\epsilon} \left(1.74 \frac{D}{d} \right) \dots\dots\dots (3)$$

where D is the mean diameter of the coil and d the diagonal of the coil section.

If the coil be square, φ_r will be reduced by about 6 per cent.

If two similar circular coils, as above described, be placed parallel to each other and at a distance apart which is small as compared with their diameter, the mutual flux per ampere cm is approximately,

$$\varphi_m = 0.19 \log_{\epsilon} \left(1.74 \frac{D}{a} \right) \dots\dots\dots (4)$$

where D is their common diameter and a the mean perpendicular distance between them.

If a is not very small as compared with D , φ_m must be reduced accordingly.

In the case of the ordinary low-voltage barrel winding D may be taken as seven-tenths of the pole pitch.

With these suggestions as a foundation excellent results have been obtained.

This method, although somewhat laborious, reduces the amount of guessing, as compared with Mr. Hobart's method, in which a combined value of the flux per ampere cm is assumed at the start; it also has the advantage of keeping clearly before the mind the factors upon which this element of the leakage depends.

This method, although somewhat laborious, involves less guessing than the short-cut methods and has the considerable advantage of keeping clearly before the mind the factors upon which this element of the leakage depends. For example it shows why the Hobart method of assuming a fixed equivalent value of the flux per ampere centimeter of the whole phase-belt bundle, gives such satisfactory results when applied to machines of widely differing proportions; at the same time it points out the limitations of this method. An example in illustration is the rewinding of a given frame for half frequency and double pole-pitch. The coil end which includes all the conductors of one phase belt, will be twice as long and twice as broad, so that the ratio of the pole-pitch to the diagonal of the coil section, and the logarithm of this ratio, will remain the same. This assumes the same shape and arrangement of coil ends, the effect of a change in which may be con-

siderable. The logarithm of the above-mentioned ratio is a very fair quantitative guide to the effect of any such change of arrangement, and is a safeguard against the blind assumption of a fixed value of the flux per ampere centimeter.

Tooth-Tip Leakage.

This refers to the leakage path that links with a single slot by way of the air-gap and of an opposite tooth-tip which bridges the slot in question. The reluctance of this path varies with the relative position of stator and rotor teeth, and may be readily calculated by an obvious method for any or all positions of the rotor. This, like the slot leakage is a purely distortional flux.

In calculation it is very important to know accurately the length of gap and the dimension of the teeth, since in some cases a very small error in the tooth dimensions makes a considerable error in the tooth-tip leakage. Saturation of the tooth-tip corners may also have a very appreciable effect, especially with open slots, where the overlapping of the teeth is small and most of the main flux is forced through the corners of the teeth.

It should also be remembered that the tooth overlap must carry both the primary and secondary leakage, which are in the same direction across the gap, see Fig. 2. Half of this overlap may be charged to the primary and half to the secondary, or all to the primary and the secondary neglected; the result will be the same when the number of primary and secondary slots are the same; in any other case the first-mentioned method is preferable.

Another important point in connection with these calculations is the tooth fringing, which is approximately equal to the length of the air-gap on each side of the tooth overlap.²

If the number of teeth be reduced one-half, the number of active conductors and the percentage of slot opening remaining the same, the reluctance of each path will be one-half as great and the conductors per slot twice as great; thus the *tooth-tip reactance will be four times as great, or inversely proportional to the square of the number of slots.*

The other factors (air-gap and slot opening), upon which the tooth-tip reactance depends, affect the exciting reactance to about the same extent, so that *this part of the leakage factor depends almost wholly upon the number of slots per pole per phase.*

² This was determined by a series of experiments carefully carried out, and its application has given excellent results in the calculation of all gap fluxes.

THEORY.

Belt Leakage.

According to the familiar method of analysis, the primary current of an induction motor may be looked upon as made up of two parts, one the exciting current, and the other the load current whose m.m.f. just balances that of the secondary current. Thus the primary load current is in general equal and opposite in phase to the secondary current; but consider the moment when a primary phase belt bridges the joint between two secondary phase belts, see Figs. 3, 4, 5 and 6. The primary load current has a phase in between those of the two overlapping secondary currents, and there result local m.m.fs. as indicated in Figs. 3, 4, and 5. The corresponding fluxes have components in phase with each of the currents with which they are linked and these components have the same effect as true leakage fluxes.

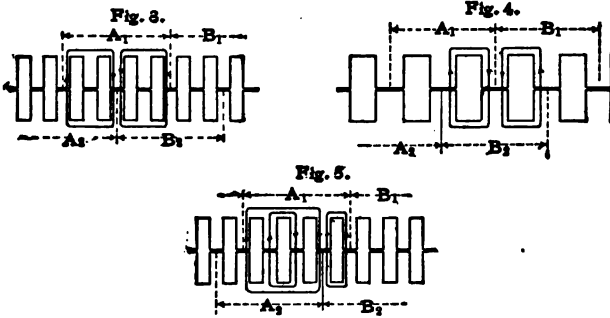

FIGS. 3, 4, AND 5.

In order to simplify matters for the time being, consider a three-phase machine with a great many very small teeth and N^1 conductors per cm of periphery in primary and in secondary. Consider the instant represented in Figs. 6 and 7. The vectors A_1, B_1, B_2 , etc., of Fig. 7, represent the currents in the corresponding phase belts of Fig. 6. The exciting current is neglected as explained above.

Consider the overlap of belt A_1 on B_2 . Then, for every ampere in the primary circuit there will be a resultant belt leakage current, a_1 (Fig. 7) $= 2 \sin^2 \left(\frac{\pi}{6} \frac{\lambda - y}{\lambda} \right)$, which will produce a leakage flux in phase with A_1 . The corresponding total flux linkage for that part of the A_1 belt which overlaps the B_2 belt, is obtained by an obvious integration. It is (for 1 cm depth of core),

$$A_1 B_2 = \frac{0.21}{10^8} \frac{KK_1 N^2}{\delta} y^3 \sin^3 \left(\frac{\pi}{6} \frac{\lambda - y}{\lambda} \right)$$

where δ is the air-gap in cms, N^2 the number of conductors per cm of periphery, K a constant less than unity that takes account of the reduction of gap section by the slot openings, and K_1 a similar constant which takes account of the ampere turns consumed in the iron part of the belt leakage path.

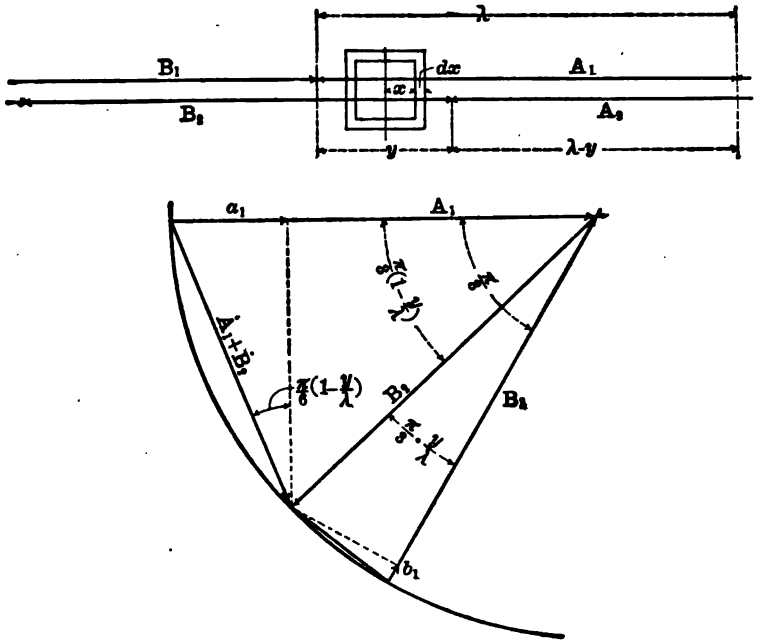

FIGS. 6 AND 7.

Similarly, the linkage for the other part of the A_1 belt is —

$$A_1 A_2 = \frac{0.21}{10^8} \frac{KK_1 N^2}{\delta} (\lambda - y)^3 \sin^2 \left(\frac{\pi y}{6 \lambda} \right)$$

and the total belt reactance per phase (primary and secondary²) for the position y is —

$$x_{By} = 2\pi n \frac{0.42}{10^8} \frac{2p l_m KK_1 N^2}{\delta} \lambda^3 \left[\left(\frac{y}{\lambda} \right)^3 \sin^2 \left(\frac{\pi \lambda - y}{6 \lambda} \right) + \left(1 - \frac{y}{\lambda} \right)^3 \sin^2 \left(\frac{\pi y}{6 \lambda} \right) \right] \dots \dots \dots (5)$$

where $2p$ is the number of poles and l_m the length of the core.

3. The secondary belt reactance is evidently equal to that of the primary, when reduced to primary turns.

The variable portion of equation 5 (within the brackets), is plotted in Fig. 7a. The presence of slots of ordinary size would of course modify this considerably.

For a two-phase motor $\frac{\pi}{6}$ is changed to $\frac{\pi}{4}$, λ is 1.5 times as large, and the volts per phase are increased in the ratio of 1.41.

The average value of the expression in the brackets is 0.009 for the three-phase and .0198 for the two-phase case. Thus, when compared on the basis of percentage reactive drop, *the two-phase belt leakage is about five times as great as that of the three-phase machine.* Also the corresponding part of the leakage factor is af-

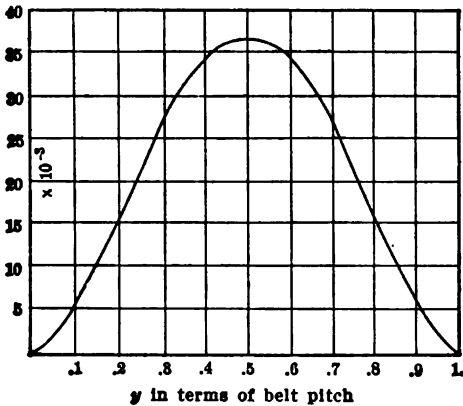

FIG. 7a.

ected in the same proportion. This difference is slightly reduced by the greater number of slots per pole per phase in the two-phase machine.

Returning to the three-phase case, the average total belt reactance per phase is —

$$x_B = \frac{4.75 p l_a n K K_1 N^2}{10^{10} \delta} \lambda^3 \dots \dots \dots (6)$$

and its maximum value is —

$$x_{Bmax} = \frac{8.9 p l_a n K K_1 N^2}{10^{10}} \lambda^3 \dots \dots \dots (7)$$

It should be noted that K varies with the relative position of rotor and stator teeth and that in equation 6 it should have an equivalent average value, whereas in equation 7 it should have the

value corresponding to the maximum belt reactance, which value is usually, though not always, the maximum for K .

If d_a = the diameter of the armature —

$$x_B = \frac{2.5 n d_a l_a K K_1 N^2}{10^{10} \delta} \lambda^2 \dots\dots\dots (8)$$

$$x_{B_{max}} = \frac{4.65 n d_a l_a K K_1 N^2}{10^{10} \delta} \lambda^2 \dots\dots\dots (9)$$

If v = the peripheral velocity of armature,

$$x_B = \frac{.416 K K_1 v d_a l_a N^2}{10^{10} \delta} \lambda \dots\dots\dots (10)$$

But the exciting reactance is —

$$x_o = \frac{1.2 K K_1 v d_a l_a N^2}{10^8 \delta} \lambda \dots\dots\dots (11)$$

where K has an average value not necessarily the same as that in equations 6, 8, and 10, except when the number of slots per belt is larger than is usual.

Thus the corresponding part of the leakage factor is approximately —

$$\sigma_B = \frac{x_B}{x_o} = \frac{.416}{120} = .00347 \dots\dots\dots (12)$$

which is a constant for all types of three-phase induction motors under the hypothetical conditions assumed; but this constancy might have been predicted since the belt leakage path is practically the same as that of the main flux.

For many purposes a more effective measure of the importance of magnetic leakage is given by the corresponding *percentage reactive drop*. When expressed in terms of the design constants, this is easily shown to be, in the case of belt leakage —

$$\%_B = \frac{100 I x_B}{E^1} = .1 \frac{K K_1 \Delta^1 V}{\delta_n B_{g_{max}}} \dots\dots\dots (13)$$

where I is the load current, E^1 the induced or counter e.m.f., Δ^1 the peripheral current density due to the load current, and $B_{g_{max}}$ the maximum value of the gap density.

Effect of Slots.

The only variable not considered in equations 12 and 13, is the *number of slots*, the effect of changing which can readily be determined by a few special cases.

Consider a machine with two slots per pole per phase, and in the position of maximum belt leakage (Fig. 4). Using the same notation as above, the maximum total belt reactance is —

$$x_{B_{max}} = \frac{18.9 n d_a l_n K K_1 N^2 \lambda^2}{10^{10} \delta} \dots\dots (14)$$

where the same interpretation of K is made as for equation 9.

With four slots per pole per phase (Fig. 3), the reluctance of the leakage path is doubled and the reactance reduced to one-half of that given in equation 8. Similarly with a larger number of slots.

TABLE I.

Slots per pole per phase.	Relative maximum belt reactance.
2	1.
4	.5
6	.417
8	.375
∞	.333

The corresponding average values do not differ quite as much as these maximum values. For an infinite number of slots the maximum belt reactance is one-third of that given in equation 14, which is a check on equation 9.

Two-Phase Belt Leakage.

For a two-phase motor the following values are readily developed —

$$x_{B_2} = \frac{10.44 p l_n n K K_1 N^2}{10^{10} \delta} \lambda^2 \dots\dots\dots (8a)$$

$$x_{B_2} = \frac{2.65 K K_1 n d_a l_n N^2}{10^{10} \delta} \lambda \dots\dots\dots (10a)$$

$$x_{o_2} = \frac{1.18 K K_1 r d_a l_n N^2}{10^8 \delta} \lambda \dots\dots\dots (11a)$$

$$\sigma_{B_2} = \frac{x_{B_2}}{x_{o_2}} = \frac{2.05}{118} = .0181 \dots\dots\dots (12a)$$

$$\bullet \quad s_{B_2} = .51 \frac{K K_1 \Delta^2 V}{\delta n B_{s_{max}}} \dots\dots\dots (13a)$$

These results have not been verified experimentally, but there seems to be no reason for discrediting them; since the correspond-

ing three-phase equations, developed in the same manner, check very closely with experiment.

Conclusions.

It thus appears that with from four to six slots per pole per phase the average belt factor σ_B is somewhat larger than that given by equations 12 and 12a, i. e., between .5 per cent and .6 per cent for a three-phase motor, which is quite an appreciable though not large item (12 or 15 per cent of the total σ in a good motor).

With a *squirrel-cage rotor* there is obviously *no belt leakage*.

The most important bearing of this element, however, is in connection with its effect upon the variation of the leakage reactance of an induction motor with the relative position of stator and rotor, and upon the interpretation of the familiar short-circuit tests. Heretofore this variation has been attributed entirely to the tooth-tip leakage.

The experiments described below show clearly the relative effect of these two elements with several types of motor. In connection with the interpretation of the experimental results, equations 5 to 10 show clearly the factors upon which the belt reactance depends.

EXPERIMENTAL RESULTS.

The experiments were so designed as to separate as far as possible the several elements of the leakage reactance. Three stator and four rotor cores, shown in Fig. 8, were wound in various ways and tested in numerous combinations with various lengths of air-gap. The length of core in each case was 8 cm.

The leakage reactance and the exciting reactance were carefully calculated from the results of a combination of short-circuit and open-circuit (stationary) tests, with the rotor in a series of positions covering one-half of the symmetrical belt cycle. In the open-circuit tests the rotor and stator windings were in turn used as primaries.

A high frequency (292 cycles per second) was used for most of the short-circuit tests in order to emphasize, and to render more accurate the measurement of, the leakage reactance. In two cases check measurements were also made at 60 cycles, with results so nearly the same as to render the cause of this difference (about 1 per cent) doubtful. The increased shielding at high frequency would tend to cause a slightly lower reactance, while the reduced

densities in the iron parts of the leakage paths would produce the opposite effect.

A long series of single-phase tests were made with one, two, three, four, and eight slots per pole, with various winding pitches, and with the rotor in the position of minimum reactance. As the number of slots was the same in rotor and stator, the tooth-tip and the belt leakage were eliminated, and by a combination of the several tests, the self and mutual reactance of the slots and of the coil ends were

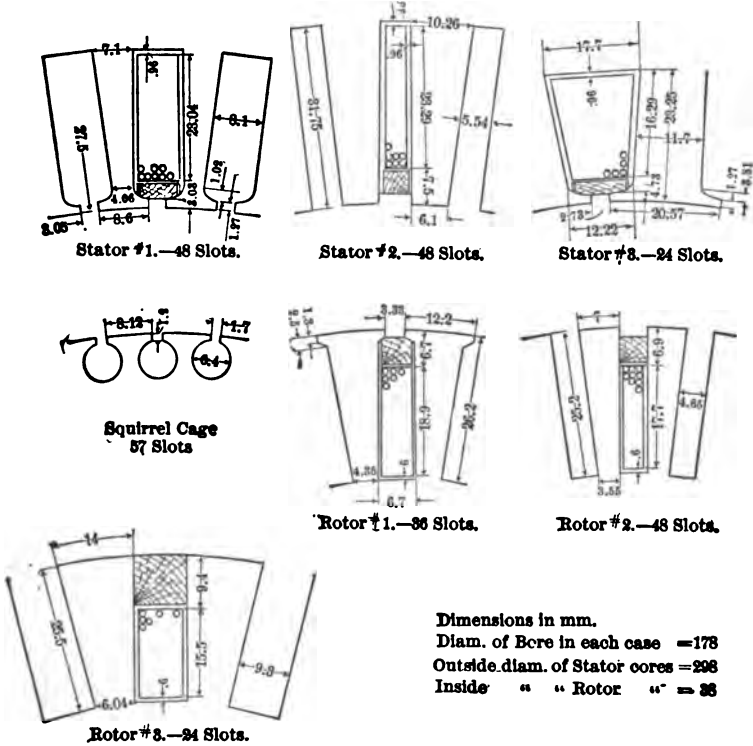

FIG. 8.

determined. Another check on the coil-end leakage was by a combination of the results of three-phase tests with windings of various pitches.

A series of tests of coils in air including the effect of the proximity of iron (cast and laminated) and other metal masses was also made.

As there is neither time nor space for the incorporation of the re-

sults of all of these experiments in the present paper (except in so far as they may have been already briefly referred to), those portions relating to the determination of the two most familiar elements (slot and coil-end leakage), will be omitted, and only those experiments related, which bear directly upon the tooth-tip and belt leakage, these two going naturally together. Of these last-mentioned experiments only a portion are here described.

In order to separate the tooth-tip leakage, several combinations were selected in which the rotor and stator had the same number of slots, and while this is not a familiar practical combination it serves the present purpose admirably.

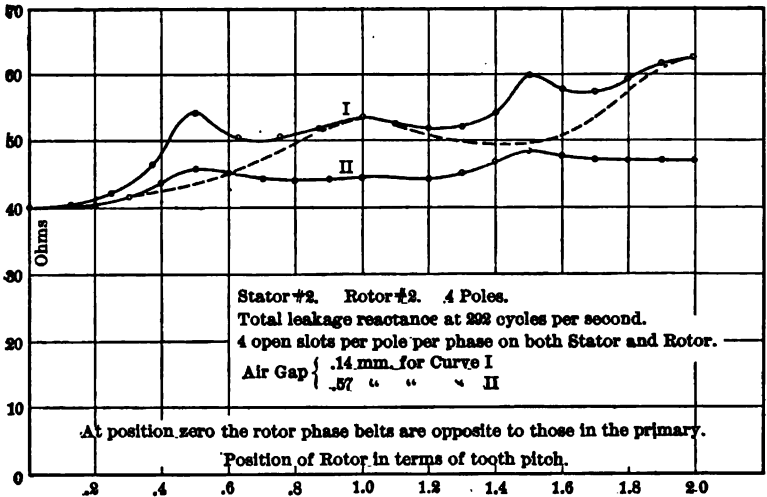

FIG. 9.

The curves of Figs. 9 to 13 inclusive show the total leakage reactance (at 292 cycles) as a function of the rotor position, the latter being measured in terms of the stator tooth-pitch. In each of Figs. 9 to 12 two curves are shown for different lengths of air-gap. As both the tooth-tip and the belt reactance are emphasized by a short gap, the corresponding curve in each case will show more plainly the manner of variation of these two elements, while the curves for the longer gap will give a better idea of the actual importance of these elements.

For the initial position (zero) the primary phase belts were set exactly opposite to those of the secondary, and the belt leakage is, therefore, zero.

Figure 9.

The difference between curve I and the broken curve shows the tooth-tip reactance; and the difference between the broken curve and the 40 ohm line shows the belt reactance.

Position Zero.

Both the tooth-tip and the belt leakage are zero, the reactance for this position being made up wholly of the other two elements, which are practically constant for all positions and air-gaps.

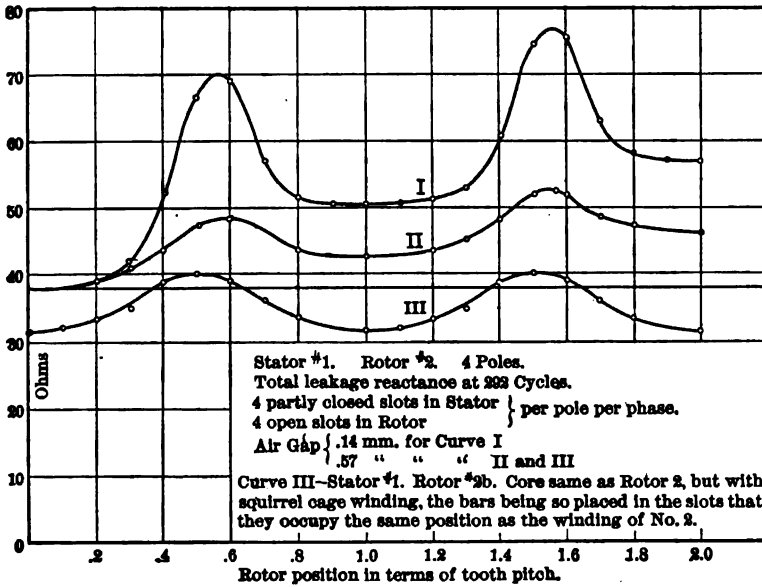

Fig. 10.

Position .5.

The tooth-tip leakage has its maximum value; the belt leakage is small not only because of the slight displacement, but also because the reluctance of the belt leakage path is a maximum. The peak at this point is narrow and low, because of the open slots.

Position 1.

The tooth-tip leakage is zero and all of the excess, over that at position zero, is due to the belt leakage. This position is represented in Fig. 5.

Position 1.5.

Tooth-tip leakage, a maximum, same as at position .5; belt leakage less than at 1. because of greatly-increased reluctance of belt path.

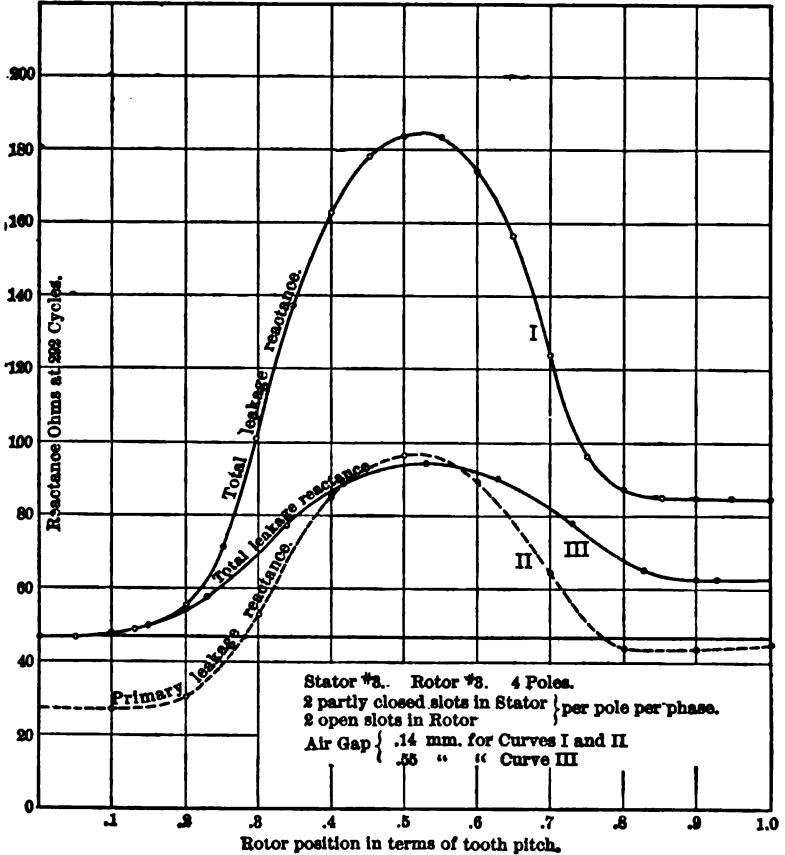

FIG. 11.

Position 2.

Tooth-tip leakage zero; belt leakage, a maximum. This position corresponds to Fig. 3 and is the point of symmetry for the curve, the other half being exactly similar.

The dependence of the tooth-tip and of the belt leakage upon the air-gap, and the independence thereof of the other two elements, is shown clearly by curves I and II.

Fig. 10 illustrates the same points except that the tooth-tip leak-

age is much increased by partly closing the stator slots. Curve III shows the tooth-tip leakage without the belt leakage. The initial value of curve III shows the saving in coil-end leakage by the squirrel-cage rotor.

Fig. 11 illustrates extreme tooth-tip leakage due to the small number of slots, two per pole per phase. It is interesting to note that the maximum belt leakage for this machine is just double that of Fig. 10, which is in entire accord with table I since K and K_1 are practically the same for both machines.

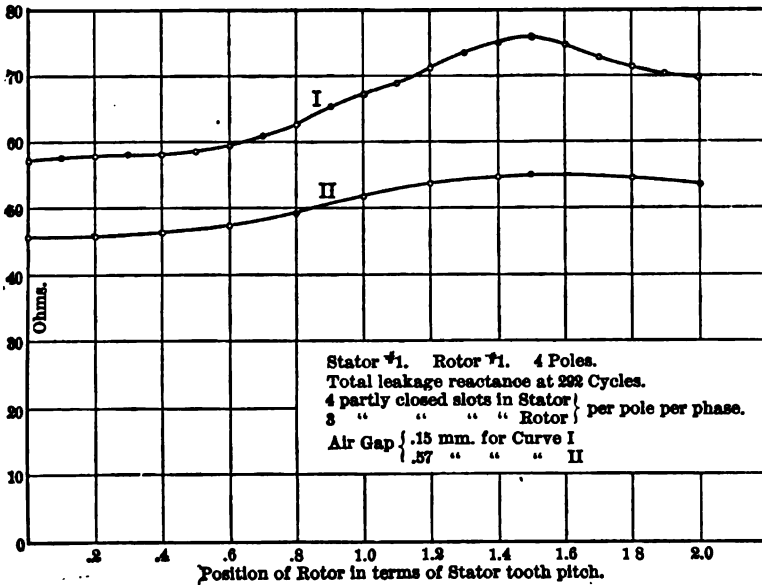

FIG. 12.

In the case of Fig. 12, the tooth-tip leakage varies only slightly from point to point, owing to the unequal number of slots on primary and secondary, and may be assumed to be practically constant. Thus the excess (over the initial value) is due entirely to the belt leakage, which does not reach its maximum value at the half-belt point (position 2), since at that point the belt-leakage path has a relatively high reluctance.

In the case of Fig. 13, curve I is the same as curve II of Fig. 9. For curve II the rotor winding was connected up six-phase, and for curve III, twelve-phase. The belt leakage is shown clearly by

the areas between these curves. These areas also show how rapidly the belt reactance increases with the minimum belt pitch, λ , (equation 8).

For curve IV both rotor and stator were rewound for eight poles, and for curve V 16-pole windings were employed. Here again the effect of changing the belt pitch is clearly shown, but with the difference that the initial values are altered, due to the changed length of end connections.

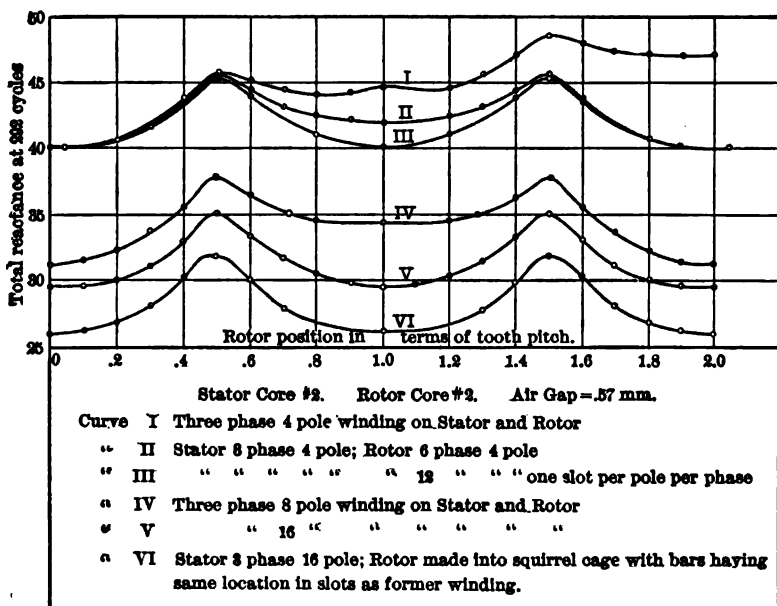

FIG. 13.

Another test was made with the rotor connected two-phase, the result being just what was predicted, an average increase of belt reactance, but a much-reduced variation of total reactance, due to the shorter belt cycle.

The experimental results considered above show clearly that even in the case of 3-phase, 60 cycle motors, the belt reactance plays an important part in the variation of the total reactance with rotor position, and that in the case of lower frequencies it becomes still more prominent.

Therefore if a reasonably-accurate measure of the leakage reactance is desired, an average should be taken over the belt cycle.



FIG. 14.— EXPERIMENTAL MOTOR.

Table II shows the interchange of relative importance between the several leakage elements as the frequency changes; it is based upon rotor No. 1 and stator No. 1 with normal gap, and assumes that the same cores are wound for the several frequencies in such a way as to keep the same peripheral velocity.

TABLE II.

Frequency.	Ohms reactance on arbitrary basis.					Per cent of total reactance.			
	Slots.	Coil ends.	Average tooth tip.	Average belt.	Total.	Slots.	Coil ends.	Average tooth tip.	Average belt.
60	19.5	16	10	4.5	50	30	32	20	9
30	9.8	32	5	7*	58.8	16.2	59.5	9.3	13
15	4.9	64	2.5	18*	84.4	5.7	76	8	15.3

*These would be 9 and 18 respectively were it not for the larger number of slots per pole per phase as the frequency decreases.

Such a change of frequency without other changes does not represent good design, but the table gives the correct general impression as to the increasing importance of the coil-end and belt leakage, with decreasing frequency.

The writer regrets very much that it has been impossible to introduce more of the methods and results of calculations, of which many were made in connection with the above-described and other tests; he expects to publish these at a later day.

In a *a priori* calculations of the several *elements* of the leakage reactance, an average discrepancy of about 5 per cent and a maximum discrepancy of 15 per cent was observed, whereas the calculations of the *total leakage reactance* showed mean and maximum errors of about 4 and 8 per cent, respectively. Moreover in the extreme cases a careful analysis always disclosed the cause of error. In the light of this experience similar calculations could be made with considerably greater accuracy, the above percentages referring to completely *a priori* calculations.

The greatest errors occurred in the calculations of tooth-tip leakage, for two reasons: First, a very slight error in the dimensions of gap or tooth-tip, or in the fringing constant, will introduce a relatively large error into the result; and second, the tooth corners being frequently highly saturated in the position of maximum tooth-tip leakage introduce an element of reluctance which it is difficult to calculate; moreover this saturation varies greatly with the rela-

tive tooth position. The fact that calculations which neglected this last-named element gave reactances invariably too large is indicative of its importance.

The results of a sample set of calculations are shown in Table III. The calculations relate to stator No. 2, rotor No. 2, curve I, and Fig. 9.

TABLE III.

	Calculated.	Observed.	% Error.
Slot reactance.....	28.9	40	-1
Reactance of end connections.....	15.7		
Max. tooth-tip reactance.....	14.5	18.5	-7.4
Belt reactance.....	Position 1. 18.14	22.5	+2.7
	Position 2. 20.9		

The agreement for the slot and coil-end leakage is unusually good, but the second and fourth items have larger errors than usual.

In conclusion, it is the writer's opinion, that the chief causes for the common discrepancy between observed values and those obtained by *a priori* calculation are:

1. The neglect of the Belt Leakage, both in calculation and in the conduct and interpretation of tests.

2. Inaccuracy of data of teeth, slots and gap. Also; that calculations of leakage reactance, along the lines indicated above, can be carried out with average errors less than 5 per cent, and rarely exceeding 6 or 7 per cent.

The writer wishes to express his appreciation of the very valuable assistance rendered by Messrs. J. C. Davenport, Delafield Du Bois, and H. W. Sturges in the preparation for and the carrying out of these experiments, and by Mr. Harold Edwards in computation.

DISCUSSION.

CHAIRMAN RUSHMORE: We must thank Professor Adams for his interesting contribution on this subject. Discussions on different electrical apparatus do not always bring out clearly that we are dealing with the same elements, and this discussion, although carried out with respect to one class of machinery, contains matter of interest to designers of all classes. It is to be hoped that at some time in the future, the subject of designing will be fully developed from the fundamental principles. We have in the apparatus magnetic circuits and electric circuits, and the work of the designer is to arrange these in such a way as to attain the desired end in the best manner. We have the inertia in each circuit, the leakage as it were, and the flux passing through the whole. Work is now being carried on by those interested in the subject, to investigate

the components of each of the elements which form the whole reaction. The subject of armature interference, under which head this might in a measure be said to come, is being continually more divided and analyzed, and we are rapidly reaching a condition where predetermination of results is possible with a considerable degree of accuracy.

A few years ago, designers of direct-current machinery did not consider the factor of self-induction, but at present there is no more important feature of direct-current designing than the self-induction of the armature coils while undergoing commutation. This self-induction is not that which has in the past been of interest to designers of alternating-current machinery, but it is the same element which enters as a factor for the limitations of design in both cases.

But not to occupy too much time, I wish to express my own appreciation of Professor Adams' work, and to bring forth the idea that all of these papers dealing with the designing of different machines are in reality only dealing with various applications of the same elements. The paper of Professor Adams is now open to discussion.

PROF. KARAFETOFF: I listened with much interest to the explanation of Professor Adams, and I would like to ask him one or two questions. As I stated in my previous remarks with respect to the paper of Professor Blondel, it is very difficult to calculate the real self-induction or leakage of an apparatus, so as to give it in numerical terms applicable for the manufacture of machinery, and I would like to ask Professor Adams if his investigation enables him to predetermine the power-factor numerically for a given frame and a given winding. Of course, large manufacturers have now-a-days no difficulty in predetermining the power-factor of an induction motor. They have such a wide experience that they know what it will be. But, generally speaking, can you take into account the self-induction of the end connections, the shape of the teeth and so on? This is the first question. As to the second question—maybe I misunderstood the explanation of Professor Adams—it seemed to me that he said that the short-circuit current varies very considerably with the relative position of the stator and rotor. Now, actual experience shows that, in making short-circuit tests on induction motors, we do not need to care very much about the position of the teeth. The short-circuit current is nearly the same in every relative position of the teeth. I have never noticed any difference in the instrument readings while the brake on the motor was shifted by more than the amount of two teeth, and I would like to know if it is necessary, in making commercial short-circuit tests, to take into account the relative position of the teeth of stator and rotor.

The third question is in relation to the coefficients of the primary and secondary leakage. I know it would be of great value for the manufacturer to know how to separate the primary from the secondary leakage on an induction motor which is already made an induction motor under test. I have myself tried to do something in this direction, but I did not succeed in separating them. In many cases the shape of the teeth and the number of teeth, primary and secondary, the voltage, the number of primary and secondary turns, are entirely different one from another, and, therefore, the primary leakage may be very different from the sec-

ondary leakage, and it would be of great importance to know them separately.

What we can do in a motor which is already constructed is, first, to take the readings of primary and secondary currents on short circuit, (supposing, of course, that the secondary is phase wound—if the secondary has the squirrel-cage winding, we can not do anything anyway). The manufacturer knows the ratio of primary and secondary turns. If there be no leakage reactance in the motor, the ratio of currents would be very near the ratio of turns, but the real secondary current is always less than the theoretical, and so we have one equation for the unknown leakage coefficients. Then we apply voltage to the primary, keep the secondary open and measure the voltages of primary and secondary. Again, if there be no leakage, the ratio of voltages would be the ratio of the number of turns, but the actual secondary voltage is less than the theoretical. Then we can apply voltage to the secondary and leave the primary open and measure the voltage in the primary.

Those are the three tests, and I tried to combine them, so as to separate the primary leakage from the secondary, but I did not succeed. I would like, therefore, to ask Professor Adams if he has succeeded in separating the primary from the secondary leakage.

PROF. ADAMS: I am not sure that I can remember all the questions, but I will take the last one first. A series of open-circuit tests was made, in which the stator was used alternately as primary and secondary, readings being taken at various rotor positions. From these tests were calculated the approximate reactances of the stator and rotor respectively. The sum of the reactances thus calculated checked very closely (within 5 per cent) with that obtained from the short-circuit test. In some extreme cases, the short-circuit test alone did not furnish sufficient data for the accurate determination of the total reactance, owing to the large exciting current even on short circuit.

In regard to the variation of the reactance with rotor position, it should be noted that except in the case of the short air-gap tests (which may be left out of consideration for the present) the conditions were such as to minimise the belt leakage, that is, the belt pitch (the most important factor in this connection) was small, 4.6 cms, or 1.8 ins. This corresponds to a pole pitch of 14 cms, or 5.5 ins. Even under these circumstances, the maximum belt reactance amounted to 20 per cent of the minimum total reactance. With a frequency of 25 cycles per second, this would reach nearly 40 per cent. The average values of the belt reactance for various frequencies are shown in Table III.

Mr. Karapetoff stated that in shop measurements, where the brake is moved back and forth so as to get an average reading, the fluctuation is not considerable for different tooth positions. This will be explained by a reference to Fig. 12, where the curves show the results of tests on a standard commercial motor. The number of slots being different on rotor and stator, the tooth-tip leakage may be assumed approximately constant for all rotor positions, and the only variation in the total reactance is that due to belt leakage. But the belt cycle extends over the belt pitch, while the tooth cycle only extends over the tooth pitch; so that it is quite

probable a rotor movement designed to detect the tooth-tip leakage would not detect the belt leakage, at least not all of it. It is probable, however, that in many cases of observed variation, the belt leakage was responsible for that which was attributed to the tooth-tip leakage.

PROF. KARAPETOFF: My other question was, whether we can calculate from the sketch of a motor the power-factor which is to be expected or not.

PROF. ADAMS: This question was not tested directly as no load tests were made; this was impossible in the time available. All calculations were compared with the reactance measurements made as described above, and with the results given on page 723. Judging by past experience in the comparison of the observed power-factor with that calculated from the observed reactances, I see no sufficient reason why the power-factor should not be completely predetermined within 1 per cent; with the understanding, however, that the dimensions of the slots, slot openings, air-gap, and location of the wire in the slot, be accurately known (with more than ordinary accuracy), and that the quality of the iron be known to a fair degree of accuracy. In case the predetermination is compared with actual observation, the latter must be made with more than ordinary accuracy.

Prof. A. S. McALLISTER: I would like to add one question. Professor Adams spoke of finding a certain ratio between the open-circuit reactance and the short-circuit reactance, if I understood him correctly.

PROF. ADAMS: Only as far as this particular element of leakage is concerned, the reason being that the reluctance of the belt leakage path is almost exactly proportional to that of the main flux path.

PROF. McALLISTER: You consider it, then, an accident of design, not fundamental to the machine? Is not the short-circuit reactance dependent almost entirely upon the distribution of the coils and slots, and the open-circuit reactance dependent entirely on the air-gap?

PROF. ADAMS: The effect of the number of slots is shown clearly in Table I.

PROF. McALLISTER: You made some statement with reference to the relation, the ratio between the open-circuit reactance and the short-circuit reactance. Perhaps I did not catch your meaning.

PROF. ADAMS: I do not now recall exactly to what you refer.

PROF. McALLISTER: Because as I understood it you brought forward some fundamental relation which existed between them, and it occurred to me at the time that one was dependent upon the distribution of the coils and slots and the other dependent upon the air-gap, and the relation would be accidental.

PROF. ADAMS: If any such statement was made, it was intended to be general, or to apply to the total reactance.

CHAIRMAN RUSHMORE: If there is no further discussion, we will pass on to the next paper—"The Regulation of Alternators," a paper of my own. Alternator regulation is to some extent an old theme. It has been the subject of a great many investigations and much has been written about it, but, so far as information has come to my hand, it has been largely theoretical and always making some assumption at the start, which, while giving that simplicity necessary for a mathematical or

graphical solution, introduces errors that in most cases invalidate the results. Very often the method advocated gives satisfactory results on certain types of machines, or under certain conditions of operation, such as at unity power-factor with a straight saturation curve, but under other conditions of saturation and power-factor the method fails to be reliable.

This paper by itself is somewhat incomplete. The investigation was begun to determine as completely as possible all of the elements which affect alternator regulation and the reactance of armature winding, one of the principal features, had to be omitted altogether after a very considerable amount of experimental work had been done in that direction.

THE REGULATION OF ALTERNATORS.

BY DAVID B. RUSHMORE.

INTRODUCTION.

The object of this paper is to give by description, inference and reference, a summary of work done and of the methods commonly used for determining regulation, and the results of very careful tests on widely differing types of machines, which it is hoped will form a contribution of real value concerning actual operation under many different conditions. The demands of brevity have necessitated that the many conclusions from these results, be omitted, and that much be self-explanatory. Reasons are not given for what is obvious.

Many theories for the determination of alternator regulation have been given by Kapp,¹ Behn Eschenburg,² Arnold,³ Rothert,⁴ Blondel,⁵ Picou,⁶ Potier,⁷ Behrend,⁸ Niethammer,⁹ Fischer-Hinnen,¹⁰ Herdt,¹¹ Adams,¹² Guilbert,¹³ Hobart & Punga,¹⁴ and others. The references cited give with much detail equations for the various factors which affect the voltage drop and many graphical solutions for the determination of the same. No useful purpose would be served by giving here a necessarily incomplete abstract of their conclusions. While empirical methods will continue to appear, and as now, will be utilized where the approximation is sufficiently close, any gain in accuracy must be due to a refinement of present methods which will allow us to obtain with greater precision the effects of primary and secondary leakage and of armature magnetization. The phenomenon is one of too great complication for a simple and accurate solution of general application to be possible.

The factors which affect the voltage drop are the ohmic resistance, armature reactance (secondary leakage), armature reaction and field (primary) leakage.

ARMATURE RESISTANCE.

Resistance drop in alternator armatures is due to three causes:
1. Ohmic loss in conductor from pure resistance drop. 2. Fou-

cault losses in large conductors from secondary fields. 3. Induced currents in neighboring metallic bodies — shields, retainers, bolts, end plates, coil supports, field collars — caused by armature or secondary fields. The energy loss in armature conductors due to primary field, such as may be found with large solid conductors, wide and open slots and saturated teeth, have but an indirect effect upon the resistance drop. The effective resistance of the armature winding due to these causes is from 10 to 60 per cent greater than the ohmic resistance of the conductor. The resistance of conductors varies with temperature (approximately .41 per cent for each deg. C above 25). The effective hot resistance is used in regulation calculations. Commercial copper wire, annealed and of high conductivity, has a resistance of 10.65 ohms per mil-ft. at 25 deg. C.

The resistance drop — often a fraction of 1 per cent, although sometimes as high as 2 to 3 per cent of the terminal voltage — is of importance, as affecting the regulation, only at non-inductive loads.

ARMATURE REACTANCE (SECONDARY LEAKAGE).

The armature leakage field is defined most properly as consisting of those lines set up by the armature current which do not interlink with the field coil. Custom in direct-current practice has divided the armature m.m.f. into transverse and demagnetizing components, the former of which represents pure armature self-induction. To these must be added, in the alternator armature, such lines as cross the slot but not the air-gap, and those which interlink with the end connections.

1. Lines which cross slot but not air-gap ^{3, 14, 16, 17, 18.}

The slot with coils is shown sectionally in Fig. 1. Armature leakage is obtained best by summation of elementary paths. The conductivity of magnetic paths for coil in bottom of slot is:

$$\lambda_s = \frac{r_6}{3 W_s} + \frac{r_7 + r_8}{W_s} + \frac{2 r_4}{r_3 + W_s} + \frac{r_5}{r_3} + 2.3 \log_{10} \frac{2 r_3}{r_3}$$

Theoretically r_3 may be taken as equal to the coil pitch. To obtain the inductance of that part of coil in slot we multiply the above expression by $\frac{4 \pi T^2 l_s}{10}$ where T = number of turns per coil and l_s = length of slot.

If the coils lying in adjacent slots are connected in series, the slot inductances are added directly. The total inductance of a group does not vary directly with the number of slots. The modification for one coil per slot is evident, and the relative influence of the different factors is clearly shown in the above expression. The saturation of the slot bridge, presupposed in the design, enters as a modifying factor. As a physical fact the m.m.f. of the armature current produces distortion of the main field but no closed lines around the slots, except between poles, with small percentage of pole arc. Except for saturation, the result is equivalent to the

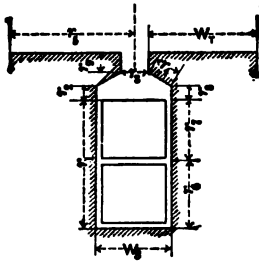

FIG. 1.— SLOT LEAKAGE PATHS.

existence of such local circuits. With open slots this element of inductance varies directly as the current. Slot inductance is sometimes approximated by assumption of constant flux per ampere turn per inch of iron.

2. Coils in Air ^{3, 17, 19, 28.}

The inductance of end connections, which may exceed that of the slot portion of coil, has been accorded proper attention but lately. It consists of mutual and self-induction, and it is estimated in a variety of ways. The armature winding may be of the barrel type with diamond coil ends and definite magnetic paths, or chain winding with rectangular ends and irregular paths for mutual flux. The inductance varies with the dimensions and form of coil section, the area and form of the enclosed end, pitch of coil, length of connection, proximity to iron, position of other coils, distribution of winding, etc.

The inductance is variously calculated by assuming an equivalent circular section and by considering the square ends as electric circuits separated by the given distance and assuming the path of

the flux through the iron to neutralize, with Foucault currents, the influence of increased magnetic conductivity³; by assuming a constant number of magnetic lines per ampere turn per inch of conductor^{20, 21, 23}; or by the use of such approximate formulæ as that given by Perry¹⁹.

The effect of mutual induction can be estimated by making a certain assumption with regard to magnetic paths and then calculating it for each coil. It may be included approximately by the addition of a certain percentage to the self-induction, regard being had to the influence of the various factors.

TRANSVERSE ARMATURE AMPERE-TURNS.

Distinction between the elements of armature leakage is one of convenience. The armature leakage field, induced by conductors directly under the pole—the so-called cross-turns or transverse armature reaction—does not interlink with the field coil. It is probable that this can produce no diminution of the total flux even with saturated teeth²². The result is a distortion of the main flux. The transverse reaction is pure armature inductance, but as a physical fact the two fields cannot exist separately. Slot leakage—best measured with rotor out—is nearly independent of the relative position of poles. The transverse and demagnetizing components vary with pole position and thus the static impedance with rotor in. The linear law for armature field in direct-current generators becomes approximately sinusoidal in alternators. An increase in variation of air-gap, decrease in percentage of pole arc, decrease in number of slots and increase in slot width, all tend to make a general mathematical or vector analysis represent less accurately the actual condition of magnetic distribution.

By way of illustration, an expression for transverse armature turns per pole is given as follows:

$$1.8 \frac{\left[1 - \cos \left(\frac{b}{\tau} \times \frac{\pi}{2} \right) \right]}{\frac{b}{\tau} \times \frac{\pi}{2}} \times m \times f_w \times I \times T_{pp} \times \cos \psi,$$

where b = pole arc; π = pole pitch; m = number of phases; f_w = distribution factor; I = current per conductor; T_{pp} = turns per pole per phase; ψ = angle between current and no-load e.m.f.

In the derivation of the above equation the following assumptions were made: Sine distribution of armature field; air-gap con-

stant over pole face; field limited by pole arc; continuous armature surface.

DEMAGNETIZATION TURNS OF ARMATURE REACTION.

Lag of armature current in alternators, as in the case of advanced brush position in direct-current generators, causes a component of armature m.m.f. to oppose directly that of the field coil. Theoretically this consists of those turns lying between the pole corners. The primary field spreads on entering the armature, so that the effective pole arc is greater than the actual. Separate elements of armature field are determined with difficulty, and for the demagnetizing turns the calculated value is used. The influence of slots, variation in wave form, gap between poles, etc., cause a discrepancy between estimated and actual values. Armature reaction is pulsating with single-phase generators, and with polyphase the fixed position with regard to the poles is subject to the influence of higher harmonics of armature reaction, which are accentuated with unequally loaded phases.

The drop in voltage due to the demagnetizing turns depends upon the degree of saturation of the magnetic circuit. Variation in pole arc has small effect on demagnetizing, and large effect on transverse turns. This is shown by a comparison of following expressions for demagnetizing armature m.m.f. (demagnetizing ampere-turns per pole) with that for the transverse turns. The symbols and assumptions are the same as before:

$$1.8 \frac{\sin\left(\frac{b}{\tau} \times \frac{\pi}{2}\right)}{\frac{b}{\tau} \times \frac{\pi}{2}} \times m \times f_w \times I \times T_{pp} \times \sin \phi.$$

FIELD (PRIMARY) LEAKAGE.

Pole core saturation renders the field leakage important. Stray flux is proportional to primary m.m.f., while useful flux depends upon the difference between opposing ampere-turns. The variation of leakage factor with load may, with saturation, have a marked effect upon excitation and regulation.

In Fig. 2, OR is the saturation curve for the total circuit and OVW that for the poles and yoke, OY representing the actual generated voltage and the flux in pole, with the no-load leakage factor $1 + L$ (L varies between .1 and .6). The full-load leakage factor

is $1 + \left(L \times \frac{OQ}{OM} \times \frac{e_r}{e_s} \right)$, and $O X$ is the actual flux in the pole at $HL = PQ$ represents the added excitation necessary because of the increased leakage factor at full load. The primary leakage varies with excitation, even at no load. Where saturation does not exist, consideration of increased pole leakage may be neglected.

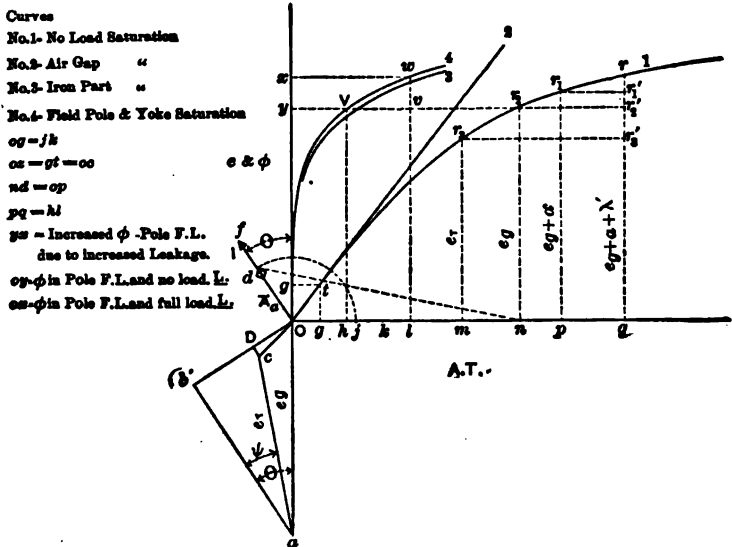

FIG. 2.— COMPLETE GENERAL DIAGRAM.

SHORT-CIRCUIT CHARACTERISTICS.

The short-circuit characteristic is an important and easily made test. All or part of the winding may be short-circuited and the voltage read from the open phases and with all phases open. Many different values for synchronous impedance are obtainable in this way and used according to experience. Fig. 3 represents the relations of the different factors on short-circuit. Transverse turns are nearly zero. The demagnetizing turns nearly equal those on the field, the small excess of the latter setting up the flux which generates the volts, i_z , necessary to overcome the armature impedance. While not exact, this diagram is of great assistance in understanding the phenomena under this condition. The short-circuit current is directly proportional to the field excitation except where saturation occurs; it is independent of the frequency until this has be-

air-gap, definite flux distribution, sinusoidal reactions and continuous magnetic surfaces, whereby the representation of magnetic fields by vectors, approximately true for induction-motor construction, departs widely from fact with varying gap, definite poles and broken circumferences. Refinements in calculation should not exceed accuracy of assumption. The demagnetizing effect of transverse m.m.f. is the element most difficult to approximate. Comparison with the more easily obtained drop due to demagnetizing turns — either by comparison of calculated values or from measurement on inductive loads and use of maximum and minimum static impedances — give results at times accurate but, on un-

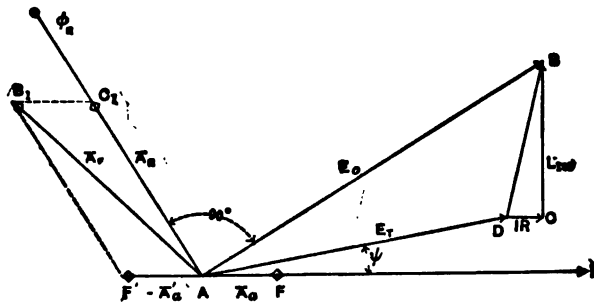

FIG. 4.—GENERAL DIAGRAM.

checked tests, uncertain. Hence the advocacy of many for the employment of zero power-factor values only.

Combined Method 8, 10, 12, 18, 18, 28.

In the comined method the armature reactance and the armature reaction are considered separately. Various definitions are used for these two quantities, but as regards the principle of the method the differences are unessential. The armature reactance may be obtained by measurement with the rotor out, by calculation from the short-circuit curve, by measurement when running with excitation and with reversed sections of armature winding, or by any of the methods used for calculation. In the same way the value of armature reaction to be employed may be variously obtained. The diagram, Fig. 4, illustrates the relation of the different factors. The e.m.f. diagram is the same as used in the reactance method, the values used being different. AF represents the armature m.m.f. in phase with current, and AF' the component of the

field m.m.f. necessary to balance it. AC' , at right angles to E_0 , is the field m.m.f. necessary for the useful flux ϕ_B and AB_1 is the resultant field m.m.f.

Fig. 2 illustrates the combined method more completely. The e.m.f. diagram is given in $AOBC$, in which AO is the e.m.f. actually generated in the winding, and AC the terminal e.m.f. with a power factor $\cos \psi$. The effective m.m.f. assumed in phase with the useful flux is laid off on ON and the saturation curves of the whole magnetic circuit and of the different parts are drawn as shown. The armature m.m.f. OD is laid off at the angle $(90 \text{ deg.} + \phi)$ from ON and at right angles to OB . The value of the apparent armature reaction as measured by short-circuited armature is given as OK . The real armature m.m.f. is equal to OJ , the difference,

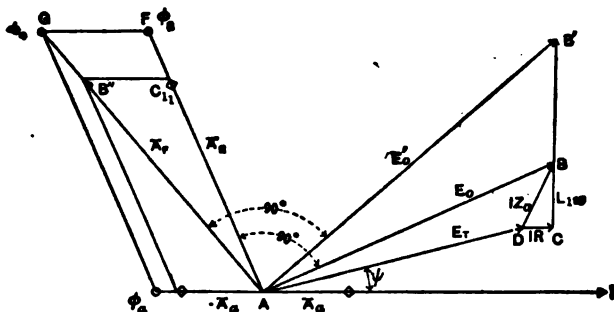

FIG. 5.— DERIVATION OF REACTANCE DIAGRAM.

$JK = OG$, being the m.m.f. required to generate an e.m.f., $OZ = OC$, being that required to send full-load current through the armature impedance; MR_2 is the terminal e.m.f. The m.m.f. necessary for generating the real generated e.m.f., $AO = NR_2$, is ON , which combined with the m.m.f. of armature reaction gives $ND = OP$ as the resultant field m.m.f. for full load. If the pole cores and yoke are worked at a high degree of saturation, a considerable increase in leakage factor occurs from no load to full load, as explained under the subject of primary leakage. Of the total drop in voltage, $r' r'_s$; r'_2, r'_3 is due to the resistance and reactance of the armature circuit, r'_1, r'_2 to armature m.m.f. and $r' r'_1$ to the increased leakage at full load.

Reactance Method 1, 2, 10, 12, 15, 24.

The similarity in effect of armature reactance and self-induction is utilized in the reactance method by combining them into an apparent equivalent "synchronous" reactance and treating the problem as one involving a series connection of two circuits, at least one of which is always inductive.

The change from the general diagram is illustrated in Fig. 5. To the true reactive voltage, BC , is added a reactive voltage, BB' , equivalent, in its effect, to the result of armature magnetization.

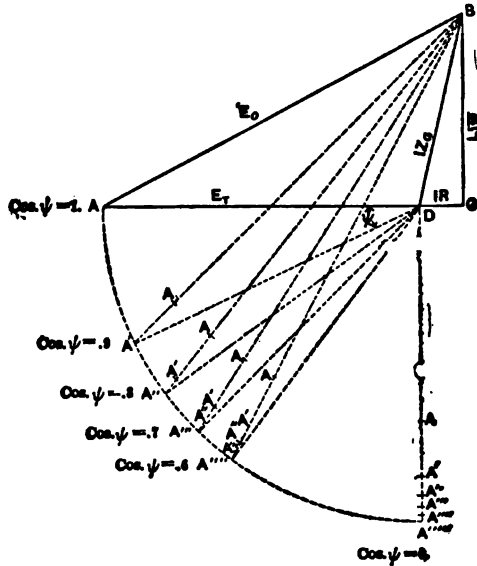

FIG. 6.— REACTANCE METHOD.

By the construction of a flux diagram similar to that for m.m.f., we obtain E_0' as the apparent equivalent e.m.f. generated in the armature, to supply a reactive pressure, $B'C$, an ohmic drop, IR , and a terminal voltage, E_t . It should be noted that a constant relation is assumed between flux and m.m.f.

The diagram for the reactance method is given in Fig. 6. In the diagram, AB represents the generated e.m.f.; BC the e.m.f. of armature reactance (synchronous); DC , the armature ohmic drop; BD , the volts of synchronous impedance; AD the terminal voltage and ψ the angle of lag of the external circuit. The full lines are for unity power factor; the dotted lines are for inductive external

circuits as shown. The relative values for apparent generated e.m.f. are shown. It will be noted that the maximum difference occurs between unity and .8 power factor, and that the drop from $P. F. = .6$ to $P. F. = 0$ is small.

The synchronous reactance is usually employed in this diagram. Experience frequently indicates some modification of method or numerical factor to be employed in order to obtain consistency between calculated and observed values. With all phases short-circuited, the armature or field current may have normal full-load value; or with a three-phase generator, the values obtained with but two phases short-circuited may be used. The free voltage from the same field current and the saturation curve may be used, or the voltage obtained from one of the open phases when but part of the winding is short-circuited.

The synchronous reactance is a convenient quantity because so easily determined, but it does not represent any definite value of

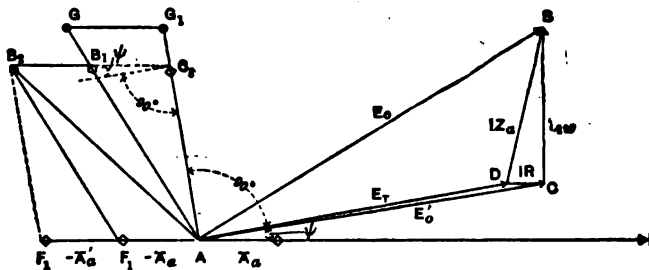

FIG. 7.— DERIVATION OF M. M. F. DIAGRAM.

armature interferences at normal operating conditions. The demagnetizing field of the wattless current is quite different in its effect from that of the same current in phase with the no-load e.m.f. vector. The saturation of the magnetic circuit also affects results. The reactance method is very simple but empirical. On types of machines possessing relatively high inductance it gives good results when used within the limits of experience.

Magnetomotive Force Method 4, 10, 12, 13, 25, 27, 28.

In the m.m.f. method, the reactance of the armature is reduced to an equivalent m.m.f. The change in the general diagram is shown in Fig. 7. The resultant diagram as usually employed

is shown in Fig. 8. The full lines give the diagram for unity power factor and the dotted, for various angles of lag. AC is the field ampere-turns for rated voltage at no load, as taken from the saturation curve. BC are the field ampere-turns to give normal armature current, all phases short-circuited. ψ is the angle of lag and AB the resultant field ampere-turns for full load, the e.m.f. corresponding to which is taken from the saturation curve.

For modern revolving-field alternators of normal design with distributed armature windings and straight saturation curves, this method gives fairly satisfactory results. By the use of a constant multiplier, determined from tests on similar machines, very close

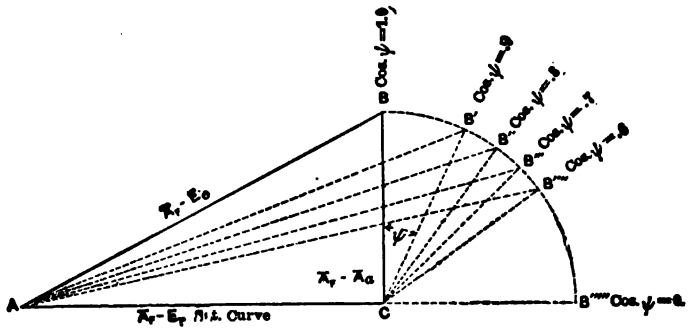

FIG. 8. — M. M. F. METHOD.

approximation to test results can be obtained. The errors involved are those due to the use of an empirical method and are greatest in machines with saturated magnetic circuits and relatively large inductance.

Arnold's Method ^{2, 10, 20, 29.}

In the predetermination of alternator regulation by this method, the true reactance of the armature circuit with rotor out is calculated by considering the part of the winding in air and in iron. The dimensions of slots, distribution of winding, shape of coil section, etc., are considered and the reactance voltage, $Li\omega$, determined. The armature reaction is resolved into its demagnetizing and cross-magnetizing components. The law of the air-gap, distribution of winding, percentage of pole arc, are considered. The

drop in the voltage (Fig. 9) $AB = E'$ due to demagnetizing component, is then found from the no-load saturation curve and subtracted directly from AO . The field due to the cross-magnetization

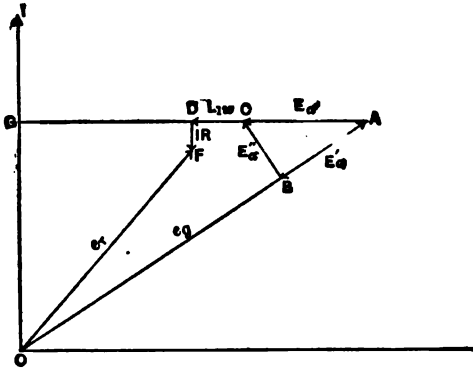

FIG. 9.—ARNOLD DIAGRAM.

is calculated, and the voltage drop due thereto is estimated by comparison with the effect of the demagnetizing m.m.f., the difference in

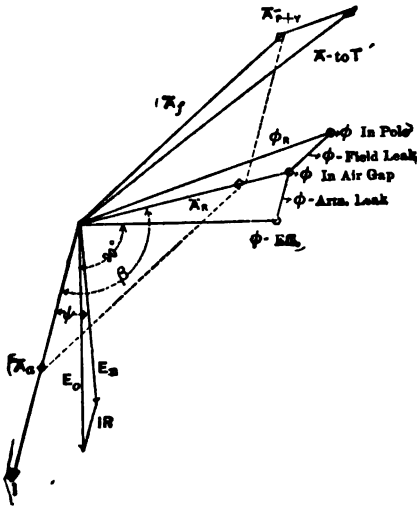

FIG. 10.—NIETHAMMER DIAGRAM.

distribution, of magnetic path, etc., being taken into account. This value is represented in $BC = E''$. The total effect of the armature m.m.f. is the e.m.f. represented by the vector AC , at right angles

to the current vector OG . To this is added the reactance drop CD and the ohmic drop DF , leaving OF as the terminal voltage.

Niethammer's Method^{9, 10}.

The diagram of Fig. 10, with the omission of true armature inductance, most clearly represents to the eye, by the combined space and time vectors, the relations of the various elements which constitute armature interference. The figure is nearly self-explanatory. The ir drop alone is considered in the armature, the m.m.f. of which is combined with that necessary, in the gap and armature iron, for the useful and armature leakage flux components. To the combination of these fluxes is added the field leakage, and the ampere-turns for pole and yoke being combined with those for the air-gap flux, give the resultant m.m.f. of primary field excitation.

TESTS.

The results of tests given in the following curve sheets are accompanied by complete design data in order that the many possible valuable deductions therefrom may be made. Space and time have prohibited a general discussion of these results which are, to a great extent, self-explanatory. The greatest care was taken with methods and instruments, and all observations which could not be repeated have been discarded. The ratings are given as convenient designations and should be considered arbitrary.

The 3500-kw generator was operated on a converter load, in parallel with a number of units of the same size. The output is used for lighting and small direct-current power in a large city. The loads on the other machines were artificial.

It is to be noted that the machines taken differ much from each other. Several complementary types are of necessity omitted, as are also sets of oscillograph curves taken for the different conditions. Normal voltages for the different gaps are fixed by the field current for approximately rated e.m.f. at the original frequency and clearance. Single saturation curves with and without load are taken with increasing field currents. Data given with the curves explain very concisely the relations represented thereby, and further discussion, because of its necessary incompleteness, is omitted. Attention is, however, called to the impedance curves. The conventional angular relation is used; zero degree represents correspondence between center line of pole and of coil group. Run-

ning impedance, a new quantity, taken with halves of each phase opposed, generator at normal speed, and at a frequency of 100, except when variable, represents an average value of the impedance under full-load conditions. It lies between maximum and minimum values of static impedance, and is constant with varying frequency and current, being affected slightly only by change in excitation. Wattmeters were used in impedance tests.

Tests are given with two phases in series. For convenience, the halves of each phase on the 65-kw machine were paralleled. On the 70-kw machine the saturation curve obtained in this way differs from that calculated from the original connection due to the presence of a third harmonic. The test at half-speed illustrates, as it should, the proportionality of the e.m.f. and the effect of armature resistance. A test of special significance is that where but one side of the inductor alternator was loaded.

In these tests instruments were placed in each phase. The same instruments were used throughout, and frequent calibration was made. Field currents are all by Weston ammeters.

Thanks are due to the Stanley Electric Manufacturing Company for data given in this paper, to Mr. George Carter who made the tests with much skill and care, and especially to Mr. Charles A. Kelsey for preparation of results.

REFERENCES.

1. G. Kapp. "Dynamomaschinen für Gleich und Wechselstrom." 3rd Edition.
2. Behn-Eschenburg. "Predetermination de la Chute de Potential dans les alternateurs en charge." *Elec.*, Paris. Vol. 10, p. 362, 1895.
3. E. Arnold and J. L. la Cour. "Beitrag Zur Vorausberechnung und Untersuchung von Ein- und Mehrphasenstromgeneratorem."
4. A. Rothert. "Untersuchen über die Kurzschlusskurve von Wechselstromgeneratorem." *Elek. Zeit.* 1899.
5. A. Blondel. "Sur La Theorie Empirique des Alternateurs." *L'Industrie Electrique*, 1899.
6. Picou. "Armature Reaction and Voltage Drop in Dynamo Electric Machines." *Bull. Soc. Int. des Elec.*, June, 1902.
7. Potier. *L'Eclairage Electrique*, Vol. XXIV.
8. B. A. Behrend. "The Experimental Basis for the Theory of Regulation of Alternators." *Trans. A. I. E. E.*, 1903.
9. Niethammer. "Spannungsabfall von Drehstromgeneratoren." *Elek. Zeit.* No. 12, 1901.
10. Fischer-Hinzen. "Berechnung des Spannungsabfall von Wechselstromgeneratorem." *Elek. Zeit.* No. 52, 1901.
11. L. A. Herdt. "The Determination of Alternator Characteristics." *Transactions A. I. E. E.*, 1902.
12. C. A. Adams. "Armature Drop and Regulation of Alternators." *Harvard Engineering Journal*.
13. Guilbert. "Armature Reaction of Alternators." *Elec. World & Eng.*, 1902 and 1903.
14. Hobart & Punga. "Contribution to the Theory of the Regulation of Alternators." *Trans. A. I. E. E.*, 1904.
15. C. P. Steinmetz. "Elements of Electrical Engineering."
16. E. Arnold. "Die Gleichstrommaschine." Erster Band.
17. H. Gallusser. "Ein Beitrag Zur Vorausberechnung der Kommutationsverhältnisse bei Gleichstrommaschinen und des Spannungsabfalls bei Wechselstromgeneratoren."
18. Niethammer. "General Altemator Diagram." *Electrician*, London, April 15, 1904.
19. Perry. "A Formula for Calculating Approximately the Self-Induction of a Coil." *Proceedings Physical Society* (London), June, 1890.
20. Parshall & Hobart. "Electric Generators."
21. Parshall & Hobart. "The Design of Alternators." *Traction & Transmission*, 1904.
22. Hawkins & Wightman. "Air-Gap Induction in Continuous Current Dynamos." *Journal Inst. of Elec. Engr.*, 1899.
23. Hobart. "Modern Commutating Dynamo Electric Machinery." *Journal Inst. of Electrical Engineers*, Vol. XXXI.
24. C. P. Steinmetz. "Alternating Current Phenomena."
25. Hawkins & Wallis. "The Dynamo." 3rd Edition.
26. E. Arnold. "Wechselstromtechnik." Vol. III.
27. De La Tour. "The Induction Motor."
28. E. Arnold. "Spannungsabfall bei Wechselstromgeneratorem." *Elek. Zeit.*, Dec. 21, 1899.
29. E. Arnold. "Wechselstromtechnik." Vol. IV.

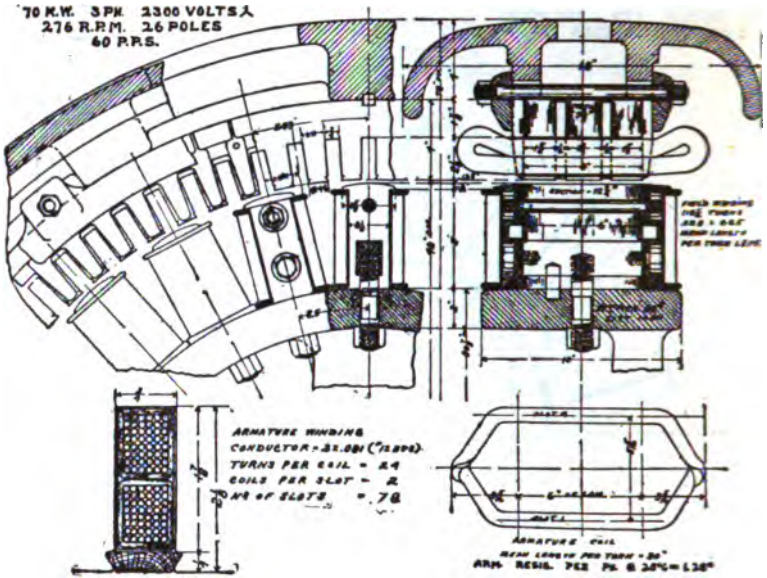

FIG. C.

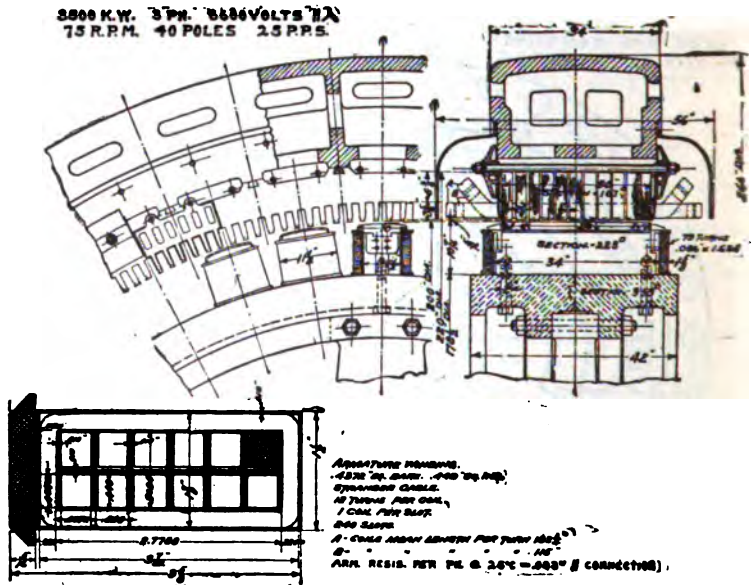
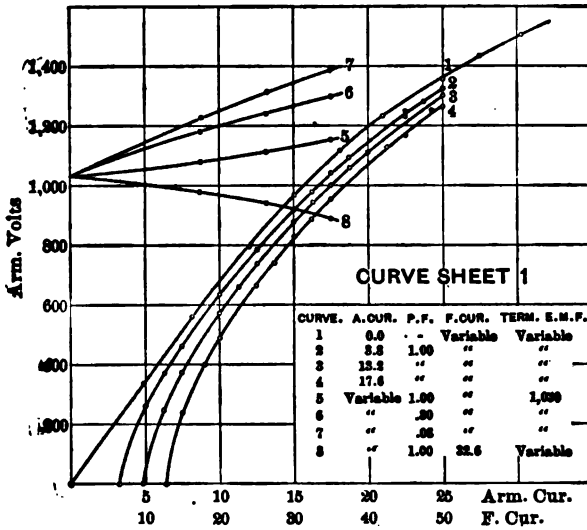
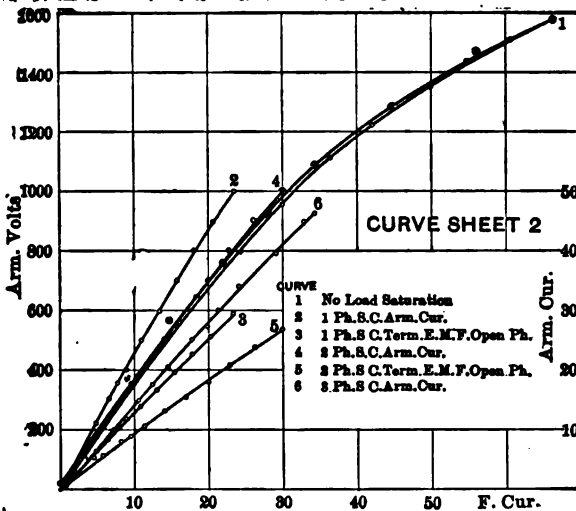

FIG. D.



CURVE SHEET 1.—LOAD SATURATION AND REGULATION CURVES.
 70 kw, 3-ph, 2300 volts Y. 60 p.p.s., 276 r.p.m., .2525" air-gap.



CURVE SHEET 2.—SHORT CIRCUIT AND SATURATION CURVES.
 70 kw, 3-ph, 2300 volts Y. 60 p.p.s., 276 r.p.m., .2525" air-gap.

CURVE				CURVE			
1	Volts A-A'	A.Cur. = 6	F.Cur. = 0.0	5	Volts C-C'	A.Cur. = 0	F.Cur. = 0.0
2	" "	" "	" = 32.5	6	" "	" = 0	" = 32.5
3	" B-B'	" = 0	" = 0.0	7	Watts A-A'	" = 0	" = 0.0
4	" "	" = 0	" = 32.5	8	" "	" = 0	" = 32.5

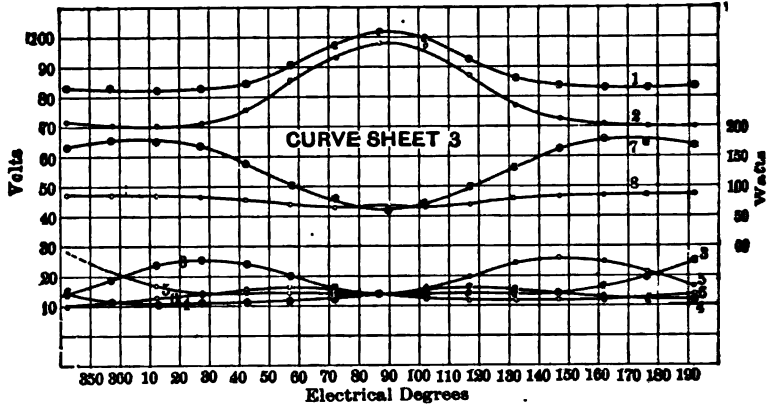

CURVE SHEET 3.— STATIC IMPEDANCE CURVES.

70 kw, 3-ph. 2300 volts Y. 60 p.p.s., 276 r.p.m., .2525" air-gap, 6 amps. forced through A-A' ph. @ 60 p.p.pa.

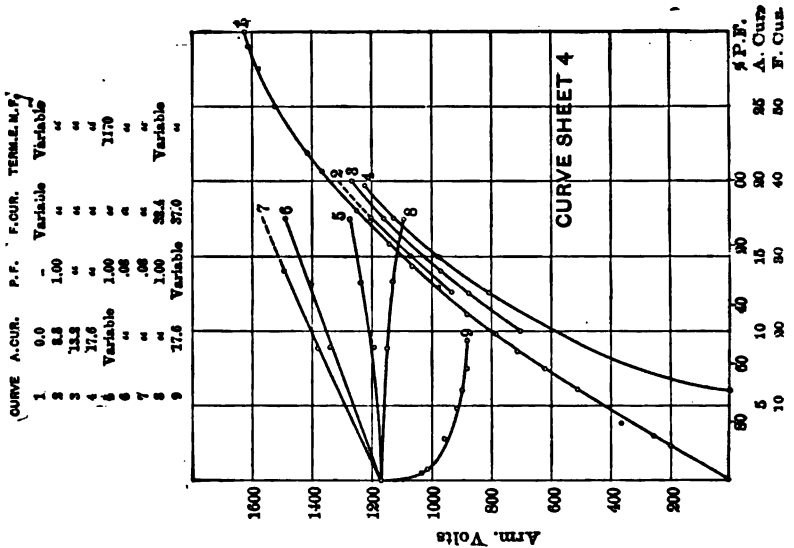

CURVE SHEET 4.— LOAD SATURATION AND REGULATION CURVES.
70 kw, 3-ph, 2300 volts Y. 60 p.p.s., 276 r.p.m., .184" air-gap.

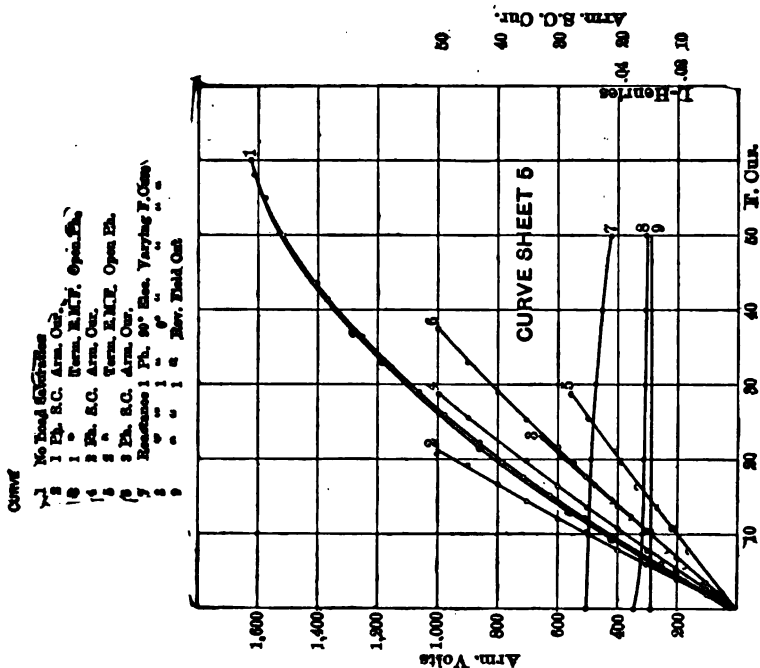

CURVE SHEET 5.—SHORT-CIRCUIT SATURATION AND REACTANCE CURVES.
70 kw, 3-ph, 2300 volts Y. 60 p.p.s., 276 r.p.m., .184" air-gap.

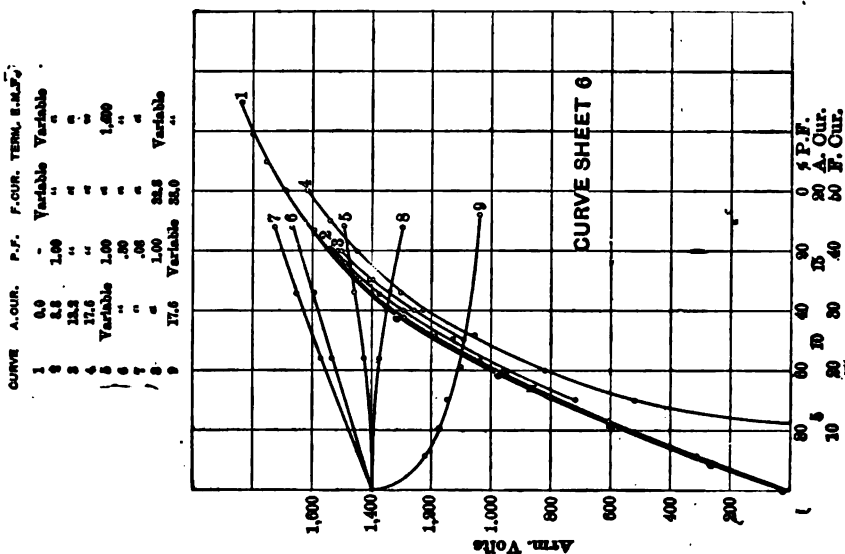

CURVE SHEET 6.—LOAD SATURATION AND REGULATION CURVES.
70 kw, 3-ph, 2300 volts Y. 60 p.p.s., 276 r.p.m., .119" air-gap.

CURVE

- 1 No Load Saturation
- 2 1 Ph. S.C. Arm. Cur.
- 3 1 " " Term. R.M.F. Open Ph.
- 4 2 Ph. S.C. Arm. Cur.
- 5 2 " " Term. R.M.F. Open Ph.
- 6 3 Ph. S.C. Arm. Cur.

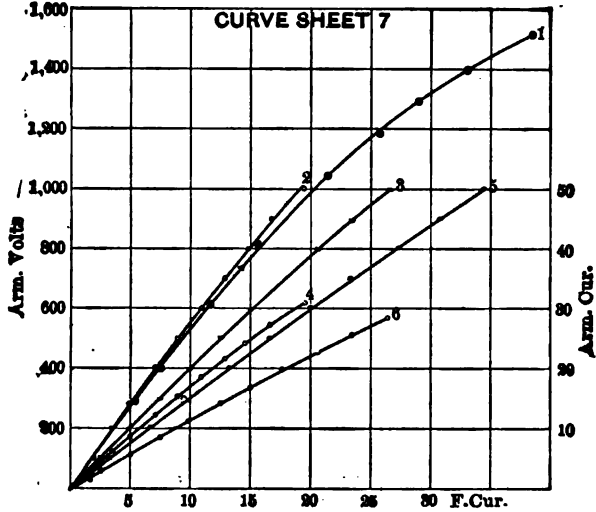

CURVE SHEET 7.—SHORT-CIRCUIT AND SATURATION CURVES.
70 kw, 3-ph, 2300 volts Y. 60 p.p.s., 276 r.p.m., .119" air-gap.

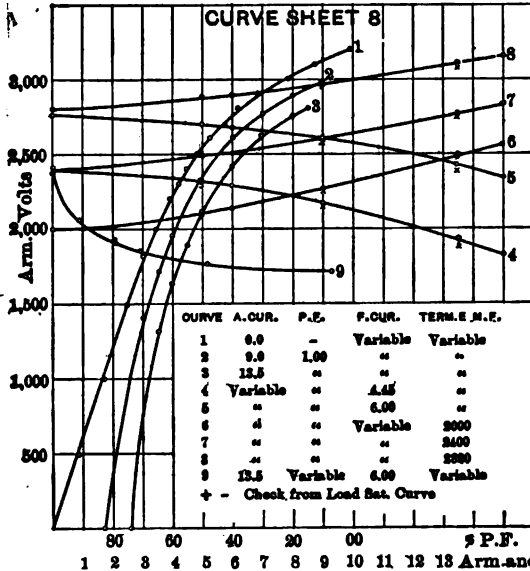

CURVE SHEET 8.—LOAD SATURATION AND REGULATION CURVES.
65 kw, 2-ph, 2400 volts, 60 p.p.s., 900 r.p.m., .0855" air-gap.

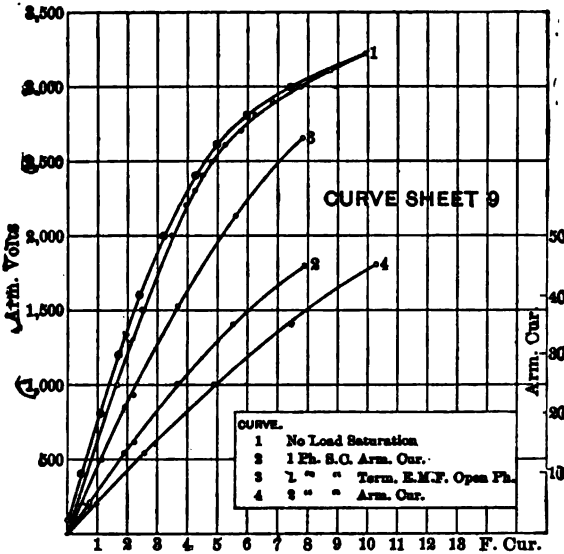

CURVE SHEET 9.—SHORT-CIRCUIT AND SATURATION CURVES.

65 kw, 2-ph, 2400 volts, 60 p.p.s., 900 r.p.m., .0855" air gap.

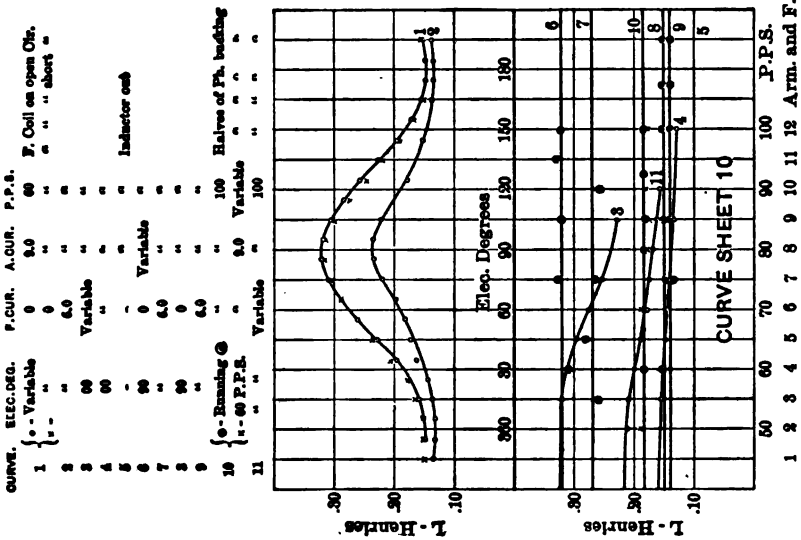

CURVE SHEET 10.—REACTANCE CURVES.

65 kv, 2-ph, 2400 volts, 60 p.p.s., 900 r.p.m., .0855" air-gap. Current forced through A-B ph.

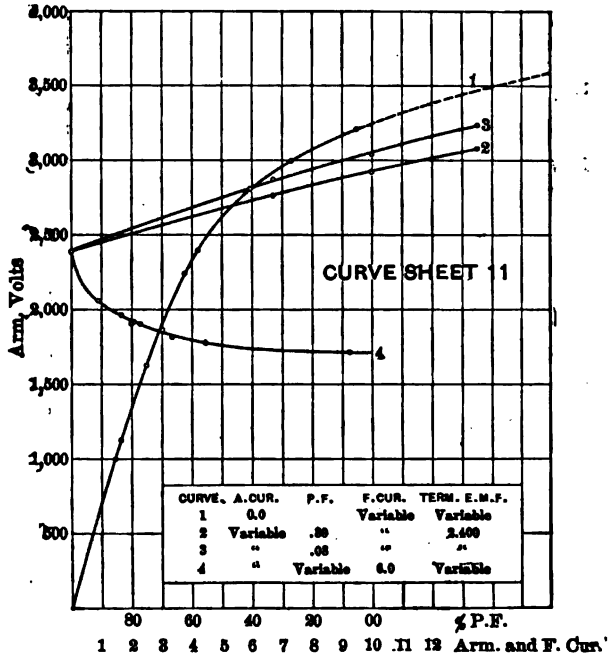

CURVE SHEET 11.— POWER FACTOR LOAD AND SATURATION CURVES. 65 kw, 2-ph, 2400 volts, 60 p.p.s., 900 r.p.m., .0845" air-gap.

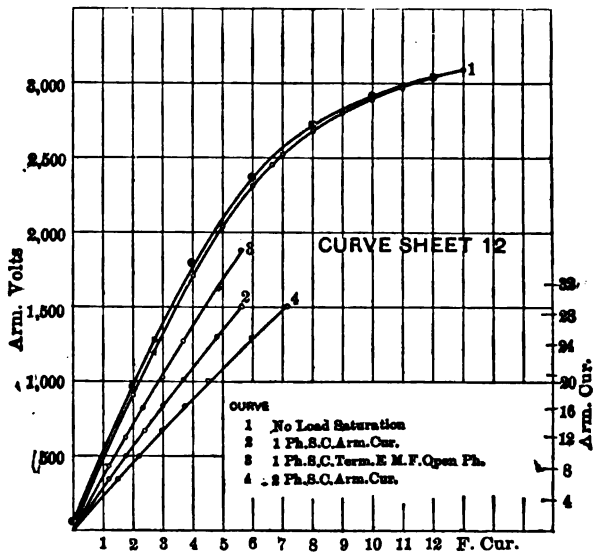

CURVE SHEET 12.— SHORT-CIRCUIT AND SATURATION CURVES. 65 kw, 2-ph, 2400 volts, 60 p.p.s., 900 r.p.m., .148" air-gap.

CURVE.	A.CUR.	P.F.	F.CUR.	TEMP.	E.M.F.
1	0.0	-	Variable	Variable	"
2	0.7	1.00	"	"	"
3	10.0	"	"	"	"
4	13.5	"	"	"	"
5	Variable	"	"	"	2.800
6	"	.80	"	"	"
7	"	.60	"	"	"
8	13.5	1.00	6.0	Variable	"
9	Variable	7.5	"	"	"

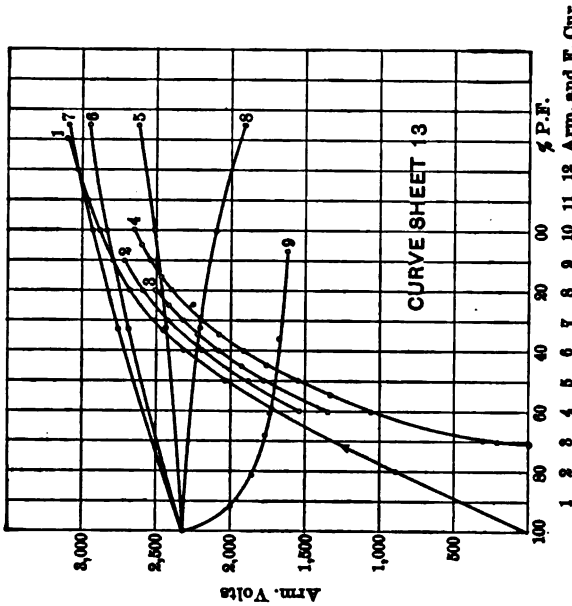

CURVE SHEET 13.—LOAD SATURATION AND REGULATION CURVES.

65 kw, 2-ph, 2400 volts, 60 p.p.s., 900 r.p.m., .148" air-gap.

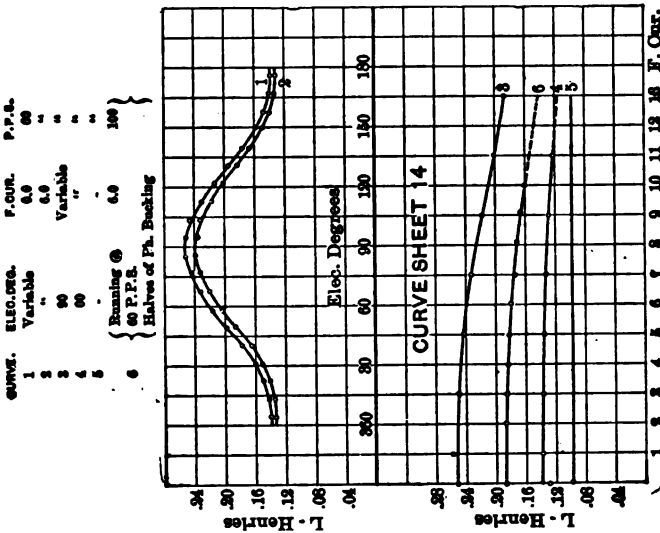

CURVE SHEET 14.—REACTANCE CURVES.

65 kw, 2-ph, 2400 volts, 60 p.p.s., 900 r.p.m., .148" air-gap. 9 ampa forced through A-B ph.

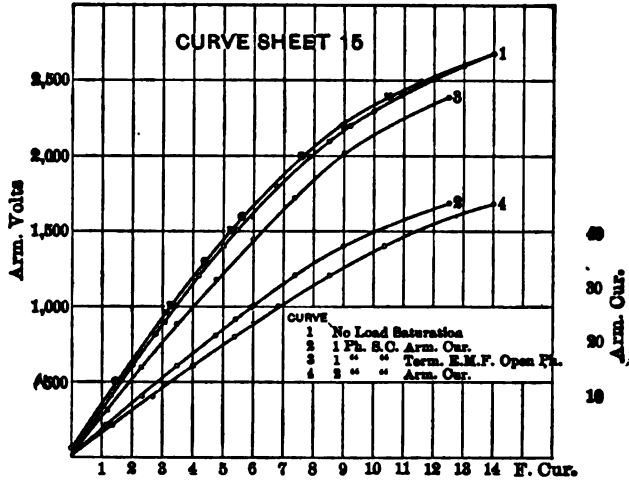

CURVE SHEET 15.—SHORT-CIRCUIT AND SATURATION CURVES.
65 kw, 2-ph, 2400 volts, 60 p.p.s., 900 r.p.m., .280" air-gap.

CURVE	A. CUR.	P.F.	F. CUR.	TERM. E.M.F.
1	0.0	-	Variable	Variable
2	6.7	1.00	"	"
3	18.0	"	"	"
4	15.5	"	"	"
5	Variable	"	4.8	"
6	"	"	6.5	"
7	"	"	7.9	"
8	"	"	Variable	2,000

* - Check from Load Sat. Curve

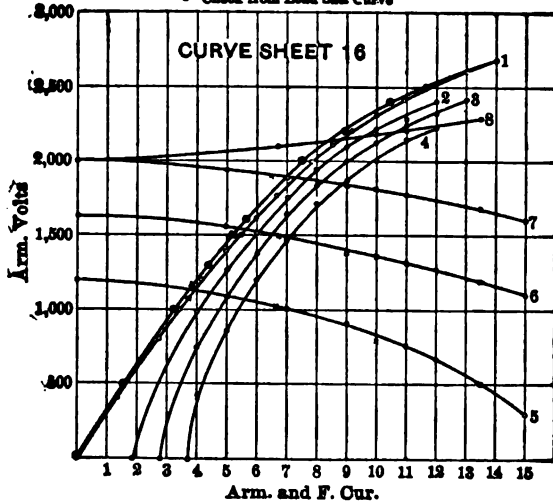

CURVE SHEET 16.—LOAD SATURATION AND REGULATION CURVES.
65 kw, 2-ph, 2400 volts, 60 p.p.s., 900 r.p.m., .280" air-gap.

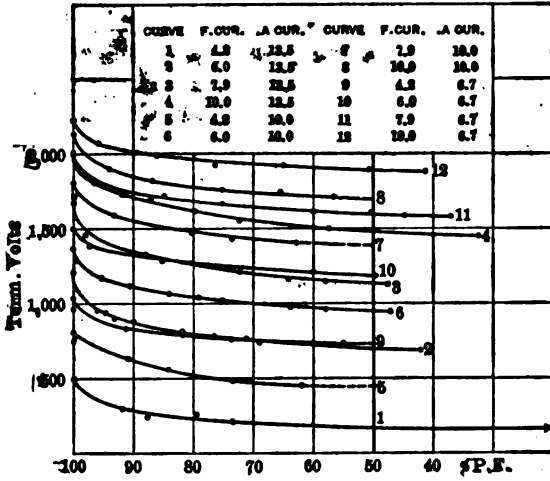

CURVE SHEET 17

CURVE SHEET 17.— POWER FACTOR LOAD CURVES.
65 kw, 2-ph, 2400 volts, 60 p.p.s., 900 r.p.m., .280" air-gap.

CURVE	A. CUR.	P.F.	F. CUR.	TERMS. V.
1	0.0	-	Variable	Variable
2	10.0	1.00	"	"
3	12.5	"	"	"
4	15.0	"	"	"
5	Variable	1.00	"	500
6	"	.95	"	"
7	"	.90	"	"
8	"	1.00	1.10	Variable
9	12.5	Variable	1.05	"
10	Variable	-	Variable	60

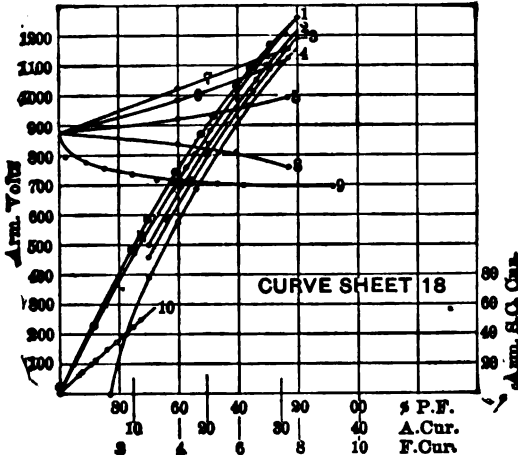

CURVE SHEET 18

CURVE SHEET 18.—SHORT-CIRCUIT LOAD SATURATION AND REGULATION CURVES.
28 kw, 1-ph, 880 volts, 104 p.p.s., 1250 r.p.m., 10 poles, .3125" air-gap.

CURVE	ELEC. DEG.	F. CUR.	ARM. CUR.
1	Variable	8.0	31.5
2	"	8.1	"
3	90	Variable	"
4	60	"	"

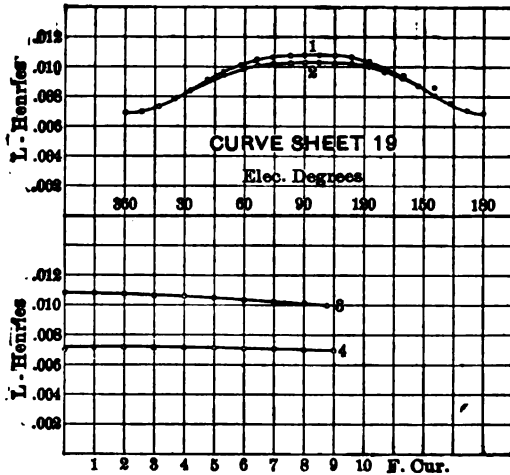

CURVE SHEET 19.—REACTANCE CURVES.

28 kw, 1-ph, 880 volts, 104 p.p.s., 1250 r.p.m., 10 poles, .3125" air-gap
Current forced through arm, @ 60 p.p.s.

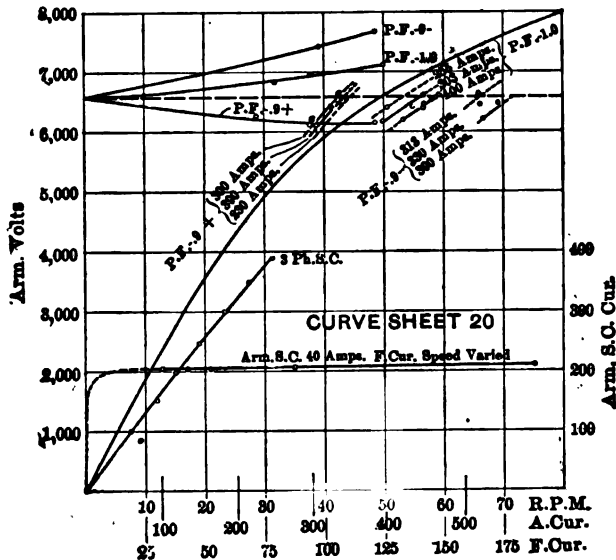

CURVE SHEET 20.—SHORT-CIRCUIT LOAD SATURATION AND REGULATION CURVES.

3500 kw, 3-ph, 6600 volts Y. 25 p.p.s., 75 r.p.m., 40 poles, .305" air-gap.

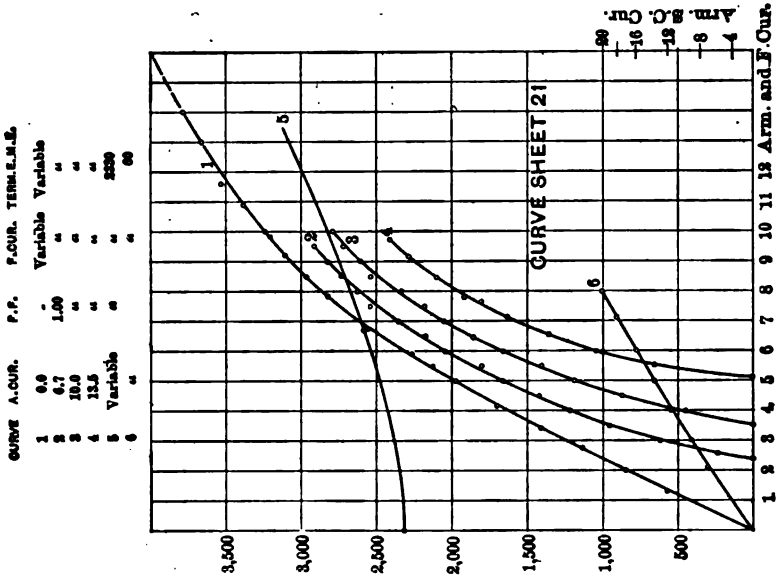

CURVE SHEET 21.—LOAD SATURATION AND SHORT-CIRCUIT CURVES.
 65 kw, 2-ph, 2400 volts, 60 p.p.s., 900 r.p.m., .280" air-gap. 2 phases in series — parallel conn.

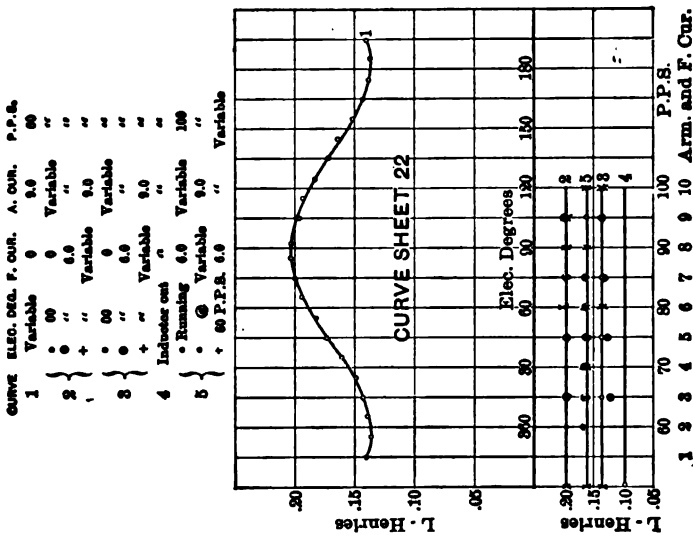

CURVE SHEET 22.—REACTANCE CURVES.
 65 kw, 2-ph, 2400 volts, 60 p.p.s., 900 r.p.m., .280" air-gap. Current forced through A-B ph.

CURVE	A. CUR.	P.P.S.	F. CUR.	TERM. E.M.F.
1	0.0	-	Variable	Variable
2	2.5	1.00	"	"
3	12.5	"	"	"
4	17.5	"	"	"
5	Variable	"	"	1.720
6	"	"	"	00

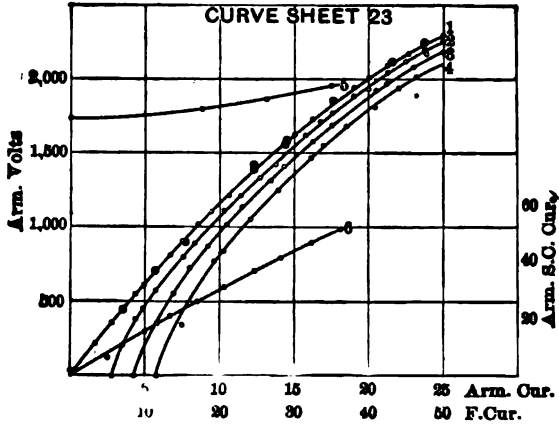

CURVE SHEET 23.—LOAD SATURATION AND SHORT-CIRCUIT CURVES.
70 kw, 3-ph, 2300 volts Y. 60 p.p.s., 276 r.p.m., .2525" air-gap. 2 phase in series.

CURVE	ELEC. DEG.	F. CUR.
1	Variable	0.0
2	"	22.5
3	90	Variable
4	00	"

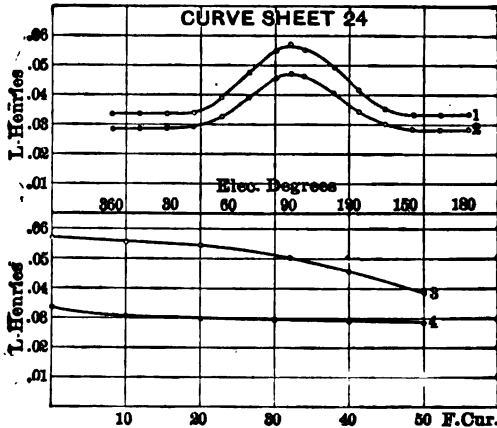

CURVE SHEET 24.—REACTANCE CURVES.
70 kw, 3-ph, 2300 volts Y. 60 p.p.s., 276 r.p.m., .119" air-gap. 6 ampa. @ 60 p.p.s., forced through 1 ph.

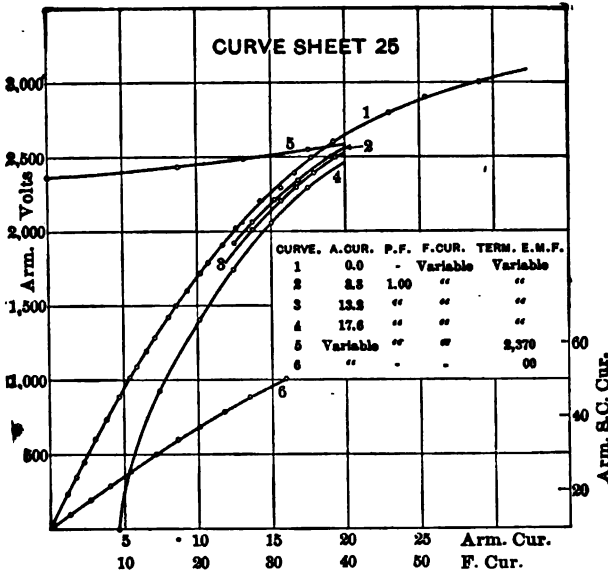

CURVE SHEET 25.—LOAD SATURATION, REGULATION AND SHORT-CIRCUIT CURVES.

70 kw, 3-ph, 2300 volts Y. 60 p.p.s., 276 r.p.m., .119" air-gap. 2 phases in series.

CURVE	A.CUR.	P.F.	F.CUR.	TERM.	E.M.F.
1	0.0	-	Variable	Variable	
2	4.7	1.00	"	"	
3	12.0	"	"	"	
4	13.3	"	"	"	
5	Variable	"	"	"	890

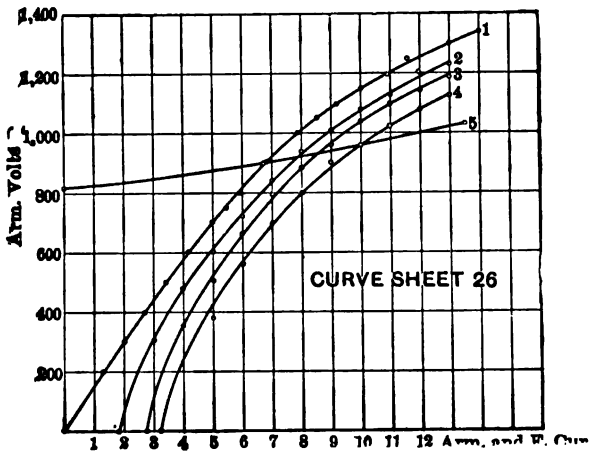

CURVE SHEET 26.—LOAD SATURATION AND REGULATION CURVES.

65 kw, 2-ph, 2400 volts, 60 p.p.s., 900 r.p.m., .280" air-gap. Generator running at 450 r.p.m.

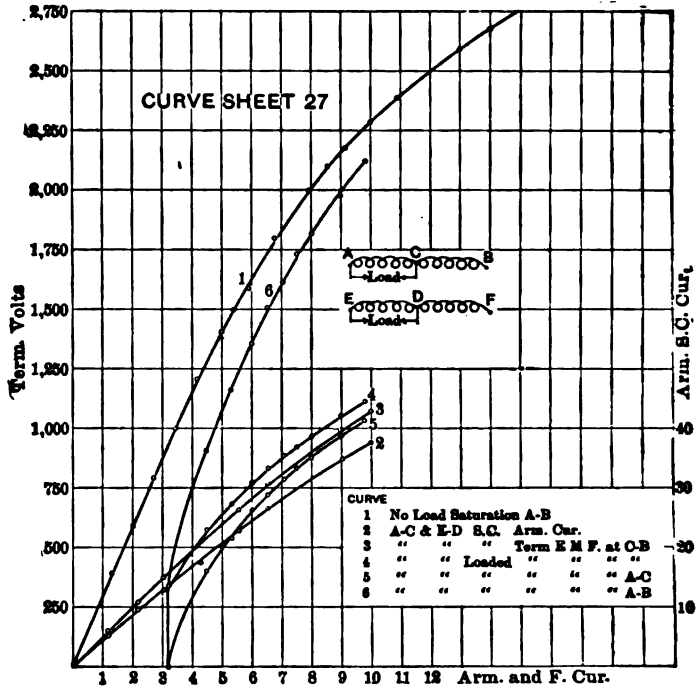

CURVE SHEET 27.—LOAD SATURATION AND SHORT-CIRCUIT CURVES.
 65 kw, 2-ph, 2400 volts, 60 p.p.s., 900 r.p.m., .280" air-gap. One side only of generator loaded @ 13.5 Amps.

DISCUSSION.

PROF. ADAMS: I think we will all agree in being very grateful to Mr. Rushmore for his valuable work, which means, as all of us know who have attempted even a small part of the work represented here, an enormous amount of care and time. The paper is rather a reference work on the matter than a subject for discussion. However, one point has been made by the author which I have recently considered, and that is the distinction between the real leakage and what may be called "distortion leakage." That is, there are two kinds of leakage in any machine with distributed winding; an actual independent flux linked with all or a part of one winding, but with no part of the other winding; and a local distortional flux which is usually calculated as independent, but which, when superposed upon the main flux, results in a distortion of the latter, or in simply a change of its distribution, so that a portion of this main flux is made to link with a larger portion of one winding than of the other. This applies to the cross-slot leakage, and to the tooth-tip leakage.

DR. DRYSDALE: In this valuable paper, which, as Professor Adams says, must have involved an enormous amount of work, I do not see that any reference is made to the method of determining regulation proposed a little while ago by Doctor Torda-Heyman, and which recently appeared in the London *Electrician*. The method of Doctor Torda-Heyman is one which is applied to the determination of regulation, when the no-load and short-circuit characteristics are given, these being readily obtained experimentally. The method appears to be so accurate that it is worth being more generally known.

CHAIRMAN RUSHMORE: As I did not say anything about it in my paper, it is but fair to add that I have read this article to which Mr. Drysdale refers which was published in the London *Electrician*. If I remember correctly, Doctor Torda-Heyman checks his methods with data recorded in the *Transactions* of the American Institute of Electrical Engineers. He gives figures only at zero power-factor, and not having had opportunity myself for checking it under other conditions, which are of course essential, I did not refer to it. It might be added that many methods will hold under zero power-factor where the distorting influence of the armature reaction, one of the most difficult features to take into account, is absent, and so, not being sure of it, I thought it better to omit, altogether, reference to it.

If there is no further discussion, we will proceed to the next paper by Mr. Alexander Heyland, entitled "Compound Self-Excited Alternators," which will be abstracted by Professor McAllister.

RECENT DEVELOPMENTS IN COMPOUNDED ALTERNATORS WITH ALTERNATING-CURRENT SELF-EXCITATION.

BY ALEXANDER HEYLAND.

The present paper relates to a system of compound alternators with alternating-current self-excitation and compounding, which system been described within the last year in a number of publications by the author and others. These publications, which appeared in different European periodicals, have all been reproduced in abstract in the digest of *Electrical World and Engineer*, and I therefore assume, that the principles of the system are known to the American public. There has been some change in a few details, which do not at all modify the system, but represent simplifications in construction not yet published. I will briefly explain the present construction of the machines by means of some illustrations and diagrams.

As is known, the main point of the system is that single-phase or polyphase alternating current generated by the machine is directly led to the field-windings for excitation and for compounding by means of a peculiar commutator. By the interposition and suitable interconnection of transformers, or by certain circuit arrangements in a single transformer, the exciting current of the machine is taken off in shunt to the main winding, and the compounding current in series, and so conducted to the commutator that the exciting current entering the field-winding remains approximately constant for all loads, while the compounding current increases and decreases with the wattless component of the main current. By proper regulation we then obtain the condition that for any load the armature reaction is annulled and the drop in voltage of the machine is compensated for, or if desired, an overcompounding of the machine with increasing load is obtained. The main feature of the machine is the commutator and the connection of the field-windings to the same. This arrangement has for an object; first, to divide the main current before it enters the main

winding, into two components, the watt and the wattless components; and to conduct only the wattless component to the field-winding, so that the exciting current in this winding increases and decreases proportionately with the armature reaction of the machine. The second object is to prevent sparking at the commutator. For this purpose, the field-winding and the commutator are so subdivided, and the field-winding connected to the latter in such a manner, that two groups of circuits are obtained. Of these the one is the field-winding and receives the exciting current, as well as the wattless component of the main current; the other consists of cross-connections between the separate parts of the field-winding, forming thus a circuit which is connected to the commutator, displaced by one-quarter of a period relative to the pole-winding, and serves to receive the remaining energy component of the main current. In consequence of a peculiar connection of the transformers, these cross-connections need not be dimensioned for the entire energy component of the main current, but only for a comparatively small part of the same. It has already been shown that, in consequence of a special circuit arrangement in the transformer, the energy component of the compounding current is compensated, and thus the cross-connections serve merely for the reception of that small part of the energy component, which cannot be avoided in practical construction.

In the first machines, the field-winding consisted of a number of parallel-wound conductors, connected to segments of the commutator lying next to one another. The field-winding was, therefore, divided into parts corresponding to the number of active commutator segments, and the circuit for the energy component of the compounding current (which, as above remarked, does not enter the field-winding) was formed by connecting the parallel-wound wires at different points with one another by cross-connections. In order to prevent a short-circuit between two neighboring brushes in any position, the cross-connections are made in such a manner as to allow each brush to span inactive segments before passing from active segments of one polarity to those of the other. The self-induction of commutation is annulled in these machines for the reason that the field-winding consists of a number of parallel wires, so that at any moment the self-induction in the separate wires is compensated for by the mutual induction

1. *Elektrotechnische Zeitschrift*, 1903, p. 1038, Fig. 22.

of the parallel-wound wires; every other tendency toward sparking is prevented by the above arrangement of the cross-connections, which accomplish the gradual cutting out of the brush current during commutation.

This arrangement of the field-winding has been abandoned in the more recent machines, mainly for practical and constructive reasons. In the first machines, the field-windings consisted, as a rule, of four parallel-wound wires. But it was soon seen to be desirable in larger machines to subdivide the winding to a greater extent and to wind six or even eight wires in parallel; for the greater the subdivision of the winding, the higher may be the brush voltage and the smaller will be the brush current and the commutator. The winding of several parallel wires on one and the same field coil presents, however, constructive difficulties. Each wire is not so firmly placed as when the entire field coil consists of a single wire, and the larger number of parallel wires leads, when going from one winding layer to the other, to overlappings which are sometimes difficult to make. Furthermore, it was difficult in different machines to find the correct position of the cross-connections, and it sometimes happened that sparks formed at some of the segments.

These deficiencies led to another field-winding, which is just as simple as that of ordinary machines, and allows furthermore of an exceedingly simple mathematical calculation of the commutation, so that in no case do difficulties due to the formation of sparks occur.

By this new construction, the separate parts of the field-winding do not consist of parallel-wound wires, but each part consists of a group of field-windings which are connected to the commutator in parallel to one another. The separate groups are constructed exactly as in the case of the field-winding of ordinary machines and consists of field coils of a single conductor. As the separate parts do not here consist of parallel-wound wires, but of separate coils of a single conductor, the current is not interrupted, as was the case in the earlier arrangement, and this is avoided in the most simple way, by placing the cross-connections at the ends of the conductors. But in this case the cross-connections, in order to prevent a short-circuit between neighboring brushes in every brush position, must have a certain resistance which, as will be shown.

must bear a very definite relation to the resistance of the field-winding itself.

The arrangement is reduced in Fig. 1 to a bi-polar diagram, and shown in Fig. 2 for a 12-pole machine. The field-winding is here subdivided into six parts. We accordingly get in the 12-pole machine (Fig. 2), 6-pole groups with two poles each, which are separately connected to the commutator. The commutator has nine

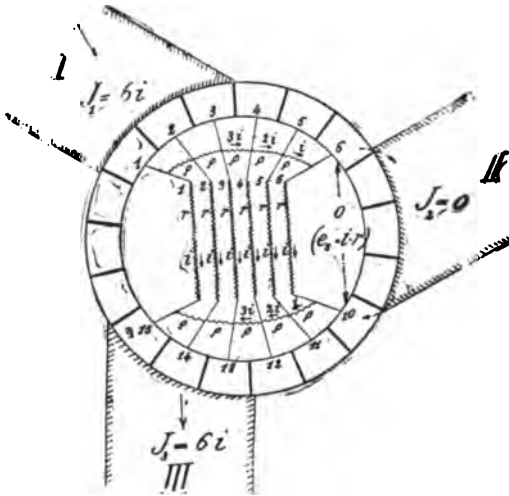

FIG. 1.

segments per pole, six active and three dummy segments. The segments per pair of poles are accordingly designated by the numerals 1 to 18, and the like segments of all poles are connected with one another. The cross-connections between the wire-ends which are designated by ρ, ρ, ρ , are joined to the commutator segments. I, II, III are the brushes, to which the three-phase exciting and compounding current is directly supplied.

Of special interest is the theoretical process of commutation and the preliminary calculations of the resistance of the cross-connections. These latter can be calculated in a very complete and exact manner, and it is shown that, with a certain resistance of the cross-connections, the commutation voltage and the short-circuit currents of commutation become nil. If then the resistance is chosen too large, a short-circuit current is produced in the one

direction; if it is chosen too small, in the other direction. That is to say, with a certain resistance of these cross-connections the commutation voltage becomes equal to zero. Even from this point of view the commutation in the present arrangement would be more ideal than the commutation in direct-current machines, in which, as is known, the commutation voltage can be brought only

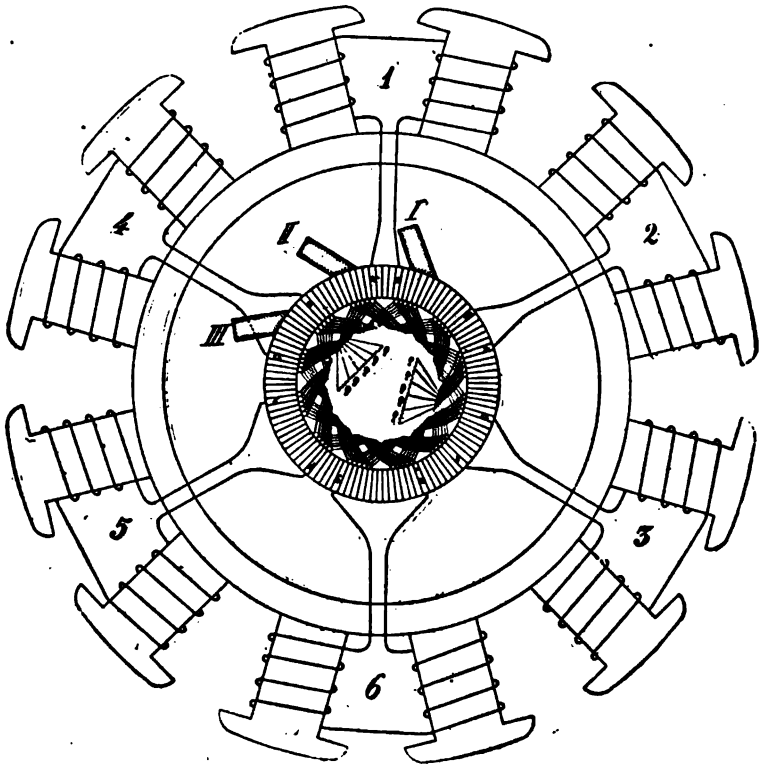

FIG. 2.

to a minimum value, and never to zero without displacing the brushes. On the other hand, we should emphasize the fact that this ideal commutation is not practically obtained here, for the field pulsations and other conditions have as effect a certain commutation voltage. However, the result is theoretically very interesting in so far as it shows that there is for the cross-connections a certain most favorable resistance, with which the commutation

becomes a theoretically complete one. From a practical standpoint we then need only to adhere to practical experience, which will show to what brush voltage we can go with a given subdivision.

The calculation is made in the following manner:

Let us consider Fig. 1. Brush II is in the commutating position, that is, the position in which the brush bridges the dummy segments and thus connects the beginning and the end of the field-winding at points 6 and 10. As above mentioned, the current of Brush II should, with an exact compounding, be in this position, $I_2 = 0$. We disregard inaccuracies and any remaining part of the energy component of the main current in this brush. A short-circuit current would take, in general, the course of the arrows shown in dotted lines at Brush II. The current in the separate parallel-connected parts of the winding is assumed to be $= i$, the resistance of the separate parts of the winding $= r$; the potential difference between the beginning and the end of the parts of the winding, lying at the time beneath the brushes—for example 1—15—is then $i r = E$, the same as the voltage between Brushes I and III. As the self-induction in the separate parts of the winding (pole groups) is very high, the separate current strengths i , i , i , can be taken as constant. As a matter of fact, these currents are not exactly constant but slightly pulsating. Thus, for example, the current in the position shown, will be a minimum in the parts of the winding 6—10, and a maximum in 1—15. Let us call the difference di . This is so much the smaller, relative to i , as the self-induction is greater, and we can, therefore, in order to dimension the cross-connections, ρ , consider the separate current strengths as constant. It is assumed that the brushes should have the width of about three segments; the currents led to the three parts of the winding shown to the right in Fig. 1 must, therefore, flow over the cross-connections, and we obtain in the cross-connections the designated current divisions—that is in the connections 5—6 and 10—11 $= i$, 4—5 and 11—12 $= 2i$, 3—4 and 12—13 $= 3i$.

That no short-circuit current may occur in the positions shown for Brush II, the voltage between the segments 6 and 10, that is between the ends of the part of the winding 6—10, must evidently be equal to zero. In this portion of the winding there appear two e.m.f.'s, which have opposite directions; first, the ohmic

drop in pressure ir , and second, an e.m.f. of self-induction, e_s , which is produced by taking off the current di in the part of the winding, 6—10. The commutation voltage then becomes zero when e_s becomes $=ir$. It is clear that for this purpose the current di needs to be only very slight, so that we may assume, without making any practical error, that current i as constant. In order that these conditions exist, that is, that $e_s = ir$, and that the voltage between the segments 6 and 10 becomes equal to zero, the drop in voltage in the shunt connections 3—6 and 10—13 must evidently be equal to the brush voltage. If ρ is the resistance of the separate cross-connections, this drop in voltage becomes

$$2(3i\rho + 3i\rho + i\rho) = 12i\rho.$$

The brush voltage was $E = ir$.

We thus have

$$12i\rho = ir$$

or

$$\rho = i/12.$$

For this value the commutation voltage would be theoretically exactly equal to zero. If we make ρ smaller, a short-circuit current will appear at Brush II in the direction of the dotted arrows; or if we make ρ larger, in the opposite direction. We see that the resistance of the cross-connections has a very definite relation to the resistance of the field-winding. Let us call the resistance of the entire field-winding, that is of the six parts in parallel, $R = \frac{r}{6}$; the resistance of the cross-connections, that is, of the 2×5 cross-connections in two groups in parallel

$$P = \frac{5\rho}{2}$$

we then have

$$P = \frac{5\rho}{2} = \frac{5r}{2 \times 12} = \frac{5R}{4}.$$

That is, the resistance of the cross-connections will be about the same as the resistance of the winding itself. While the current in the field-winding is $I = 6i$, the mean current of the cross-connection would be about $2i$, that is, only about one-third of the entire current of the field-winding. The additional losses in the cross-connections are, therefore, not more than 10 to 15 per cent of the losses in the field-winding.

The resistance of the connections ρ depends upon the number of parallel groups and on the breadth of the brushes. In practice the brushes are made, for example, in the preceding case not 3 segments but 4 to 5 segments wide; so that they shall bridge across the blind segments which are not connected to the winding. In this case for the position of the commutator shown in the illustration, the connections between 3 — 4 and 12 — 13 are without current, and the resistance of the shunt connections must be approximately

$$\rho = \frac{r}{6}.$$

The shunt connections are, therefore, greater, but the losses smaller, since the mean current decreases; so that in general the losses in these shunt connections amount to less than 10 per cent of the losses in the field-winding.

Should the field-winding be subdivided into another number of parallel groups, the resistances of the shunt connections are altered correspondingly and may be readily determined for each particular case.

Compared with the earlier arrangement, this construction with cross-connections of a certain resistance at the exterior ends of the wires is, in respect to the losses, clearly advantageous; the losses were formerly greater for the reason that but one part of the winding was in circuit and the entire current was distributed to the different parts of the winding in different proportions.

The construction of this arrangement is also exceedingly simple as to the remaining part, as shown by a glance at Fig. 2. Without the necessity of bringing the beginnings and ends of the winding together, the connections can be made symmetrically around the commutator, and the cross-connections, which require a comparatively small space, can be easily located at any place.

No difficulty is involved if, for example, it is desired to subdivide the field-winding into a number of groups not directly divisible into the number of poles. It is then only necessary to subdivide the field-winding into groups of different numbers of poles, the numbers of turns being so dimensioned that they shall be proportioned to the same terminal voltage. The largest groups are then preferably placed in the middle and the smaller ones on each side. The machine may, for example, have 10 poles, and have to be subdivided into 6 groups. The field-winding can then

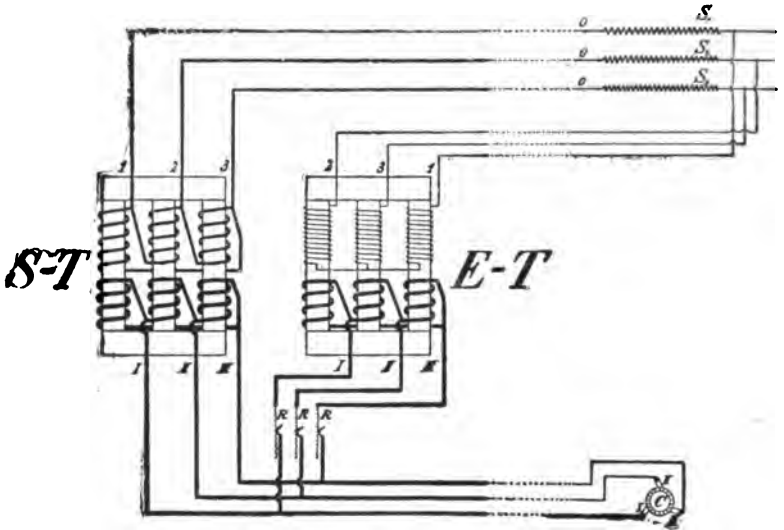

FIG. 3.

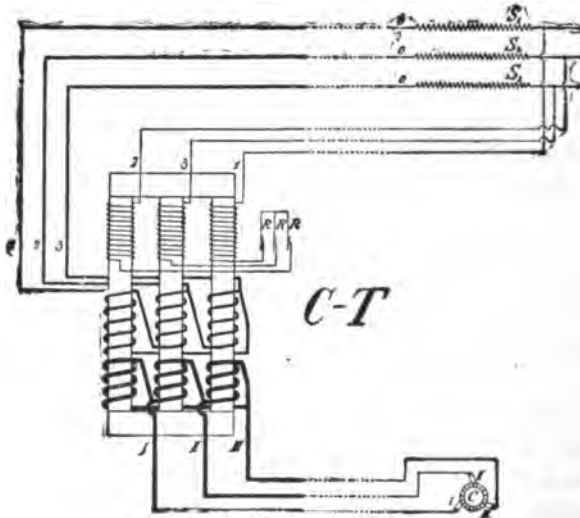

FIG. 4.

be divided into 4 groups of 2 poles and 2 groups of 1 pole, so that the last-named poles shall receive the double number of turns of half cross-section with respect to the remaining poles. The connections are preferably so arranged that the groups 1 and 6 are

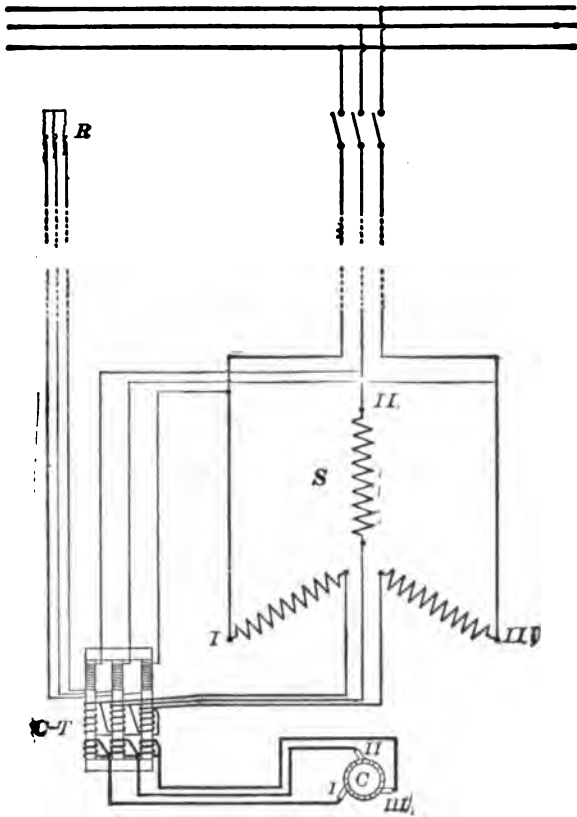

FIG. 4a.

each apportioned to one pole, and the remaining groups 2, 3, 4, 5 to two poles.

The customary transformer connections for compounding by means of two or a single transformer have been described in former publications and are shown for example in Figs. 3 and 4 for three-phase generators. In the connection of Fig. 3, the shunt-regulating resistance can be put into the low-pressure secondary circuit of the shunt transformer. In the connection with a single

transformer, however, Fig. 4, we have but one secondary winding, and the shunt-regulating resistance must, therefore, be put into the primary shunt coil, which might cause difficulty in high-voltage machines. In this case it is advisable, instead of directly connecting the resistance, to connect a step-down transformer to the primary coil and to put the resistance in the secondary coil of the transformer.

Fig. 4a shows a suitable assemblage of the parts shown according to Fig. 4. The transformer is here brought close to the machine and on the switchboard is placed only the main switch and the shunt-regulation resistance. As above stated, the transformers, or if but a single transformer is employed, the different windings of the transformer, are so interconnected with one another, that the wattless component of the main current combines directly with the exciting current, which is always an energy current. To accomplish this the two primary shunt and series coils of the transformer belonging to one and the same secondary phase are connected to the main winding of the generator with a relative displacement of one-quarter period. Figs. 3 and 4 show the same connections, with the difference that in Fig. 4 the shunt and series coils are on the same transformer, so that the two parallel-connected secondary windings combine into a single winding. In Fig. 3, *ET* is the exciting transformer and *ST* the compounding transformer. In Fig. 4, *CT* is the combined compounding transformer. The primary terminals lead to the main winding of the generator, S_1 , S_2 , S_3 , connected in one case in series and in the other in parallel. The secondary terminals of the transformer lead to the commutator *C*. The displacement by 90 deg., relative to the shunt current of the series current, accomplished by the interconnection, can be easily seen in the diagrams. If we consider first the series circuit, we see that by the series connection the like phases are directly connected in series. Thus we have for example

Brushes I—II in series with the stator phases S_1 — S_2
 Brushes II—III in series with the stator phases S_2 — S_3
 Brushes III—I in series with the stator phases S_3 — S_1 .

If, however, we consider the shunt circuit, we see that by the shunt interconnection the brushes are connected in parallel to stator phases displaced by a quarter of a period (90 deg.), we have

Brushes I — II are in parallel with the stator phase $S_3—0$

Brushes II — III are in parallel with the stator phase $S_1—0$

Brushes III — I are in parallel with the stator phase $S_2—0$.

Thus we have

$S_1—S_2$ displaced by a quarter period relative to $S_3—0$

$S_2—S_3$ displaced by a quarter period relative to $S_1—0$

$S_3—S_1$ displaced by a quarter period relative to $S_2—0$.

This connection is the one for the case in which the succession of the phases, that is, the direction of rotation of the field, is $S_1—S_2—S_3$. If the direction of rotation is the reverse one, the primary coils of the shunt connection are to be reversed.

The transformer connections can be made in other ways for the same purpose. For instance, the series winding of the transformer can have the individual phases star-connected, while the shunt winding can be mesh-connected, the individual windings being thus so inter-connected that there is a phase difference of a quarter of a period between the series and the shunt windings.

In parallel connection the compound machines work excellently, and if they are compared with ordinary machines of small armature reaction, they will be found even better than the latter. For parallel connection the series windings of the transformers are connected together through three-compensating conductors, either at the terminals, or at selected points of the winding. Consequently, the machines work directly upon and through one another as though the compounding was altogether removed; and since, in general, compounding machines are built with larger armature reaction than ordinary machines, they work well together in parallel connection. The compounding works only externally, and, on account of the compensating conductors for all parallel machines, together. That is to say the machines behave in this respect very advantageously. They combine the advantages of machines of large armature reaction (as to operation in parallel), with those of machines of smaller armature reaction (as to constant pressure regulation).

Similarly, these machines work very well if connected in parallel with ordinary machines, and in existing stations. In this case, one must naturally take care that the machines are at least sufficiently large that its load corresponds to the wattless currents of the plant, since otherwise they could be overloaded. When one connects a compounded machine in parallel with an existing plant it corrects entirely automatically all pressure variations. The machines are,

therefore, well adapted to installation in systems in which larger voltage variations are present. If, for example, it is desired to keep the voltage constant at certain points in a network, this can be accomplished in the simplest manner by connecting at these points the compounded machines in parallel as motors running light. The machines then regulate the voltage in the same manner as, for example, overexcited synchronous motors have frequently been used hitherto; but with the difference that the compounded machines will not, as in the other case, have to be kept adjusted by hand, but work automatically and take up automatically and instantaneously every variation of voltage.

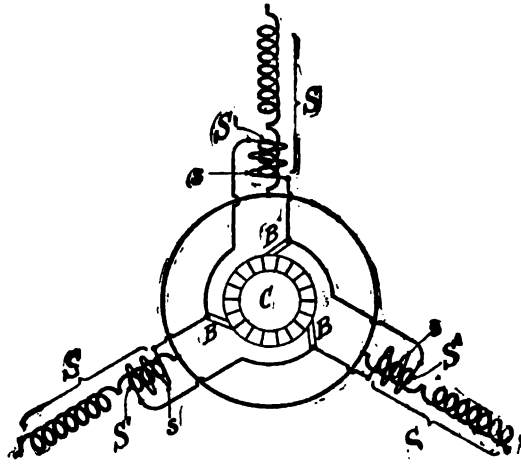

FIG. 5.

Finally I will mention a more recent compounding connection, which is of interest in so far as the connection can be applied directly to the machine without the interposition of transformers. In this arrangement the polyphase-exciting current is generated in three auxiliary coils which are located on the stator. In order that such a machine may be at the same time compounded, a most simple arrangement has been devised whereby, in the same slots in which the auxiliary winding lies, there is placed also a part of the main winding, the respective coils being, however, connected in opposite directions to the remaining part of the main winding. The arrangement is diagrammatically shown in Fig 5. *C* is the com-



FIG. 6.

mutator, $B B B$ are the brushes and $s s s$ the three auxiliary coils wound on the stator and supplying the exciting current. $S S S$ is the main winding of the stator, and $S^1 S^1 S^1$ the part of the main winding which lies with the auxiliary winding in the same slots. These coils are connected in opposite directions to those of the remaining part of the main winding. We can then consider the auxiliary winding together with the coils of the main winding lying in the same slots as a compounding transformer. The compounding is effected under the influence of the stray field of the machine, which is quite sufficient for the purpose. If the machine is loaded with a more or less inductive current, which has a tendency to produce a decrease of the field in the main winding, the same current will cause in part S^1 of the main winding, which is wound in opposite direction to the remaining part, a corresponding increase of the field and thus correspondingly increase the exciting voltage of the exciting current in the auxiliary winding s . With a suitable choice of the number of turns of the compounding coils of the main winding we can in this manner obtain a complete compounding, without employing a compounding transformer.

This mode of connecting is mainly advisable for smaller machines, in which it is of interest to reduce the cost of the machines to the extent of the cost of a transformer. It moreover has the advantage that it is very simple, consisting mainly in reversing the direction of connection of the coils of the main winding (which lies in the same slots with the auxiliary winding) with regard to the remaining main winding.

Fig. 6 shows a view of a standard machine, from which all relations can be clearly seen. As shown, the commutator is of very moderate dimensions in comparison with the total size of the machine and can be easily placed where otherwise the slip-rings or the exciting machine would be located. The machine represents one of the first constructions, in which the field-winding consists of parallel-wound wires; the field-winding can be clearly seen at the lower part of the field-frame. All machines at present in course of construction are being built according to the diagram of Fig. 2, otherwise nothing has been changed in the exterior appearance of these machines.

Figs. 7, 8, 9 and 10 are the working drawings of different machines constructed, from which all details can be seen. The commutator is always placed at the point usually reserved for the slip-

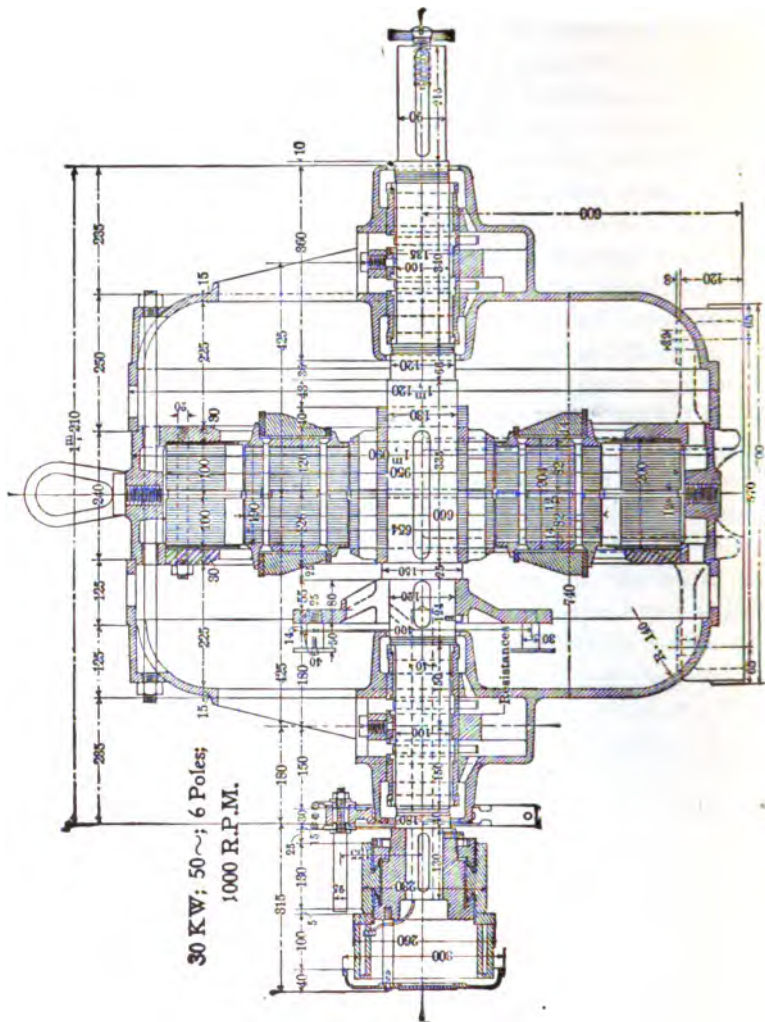

FIG. 7.

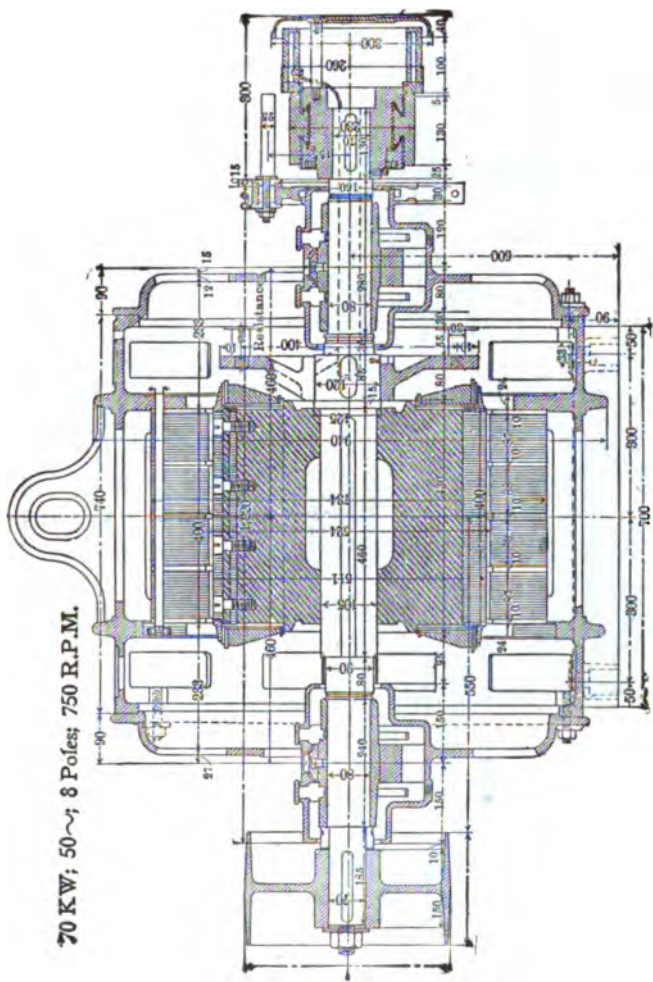

Fig. 8.

rings; in the smaller types, Figs. 7 and 8, outside, in the larger, Figs. 9 and 10, inside of the bearings. The resistances which form the cross-connections between the different wire ends are in all cases located by the side of, or in the interior of, the field ring. A

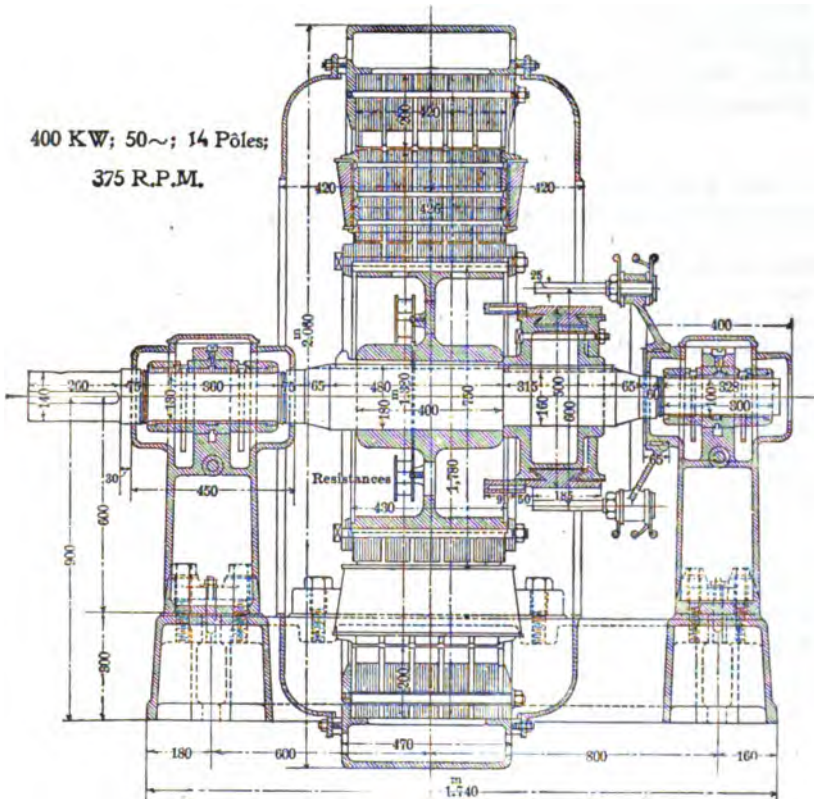

FIG. 10.

characteristic feature of all machines is the reduction of the field copper obtained by the compounding, which is clearly seen in the working drawings.

All the generators described above are high speed machines, but lately the same principles have been applied, with advantage, to the construction of slow speed machines. Up to the present the largest machine of this character in actual service is one of 500 horse-power, running at eighty-three revolutions per minute.

All the machines constructed have given every satisfaction under

the actual conditions of operation, the automatic compounding having been found to be of the greatest service, in particular in those installations where heavy variations in the load are met with.

On account of the fact that no exciters are used with the machines, the automatic regulation takes place instantaneously even when the variations in load are very sudden, such as is the case, for instance, when large induction motors are switched on to the lines. Even under such conditions no appreciable variations in the generator pressure arise.

DISCUSSION.

PROF. KARAPETOFF: Mr. Heyland has developed during the last few years several types of machines, and there is one thing common to them all, that is, the application of a special type of commutator. Every few months we read in German or English periodicals that Mr. Heyland has made a change in the construction of his compensated alternator. But there is one thing, which could be called the "sifting device," which remains unchanged, and I think the whole value of this invention is in the sifting device. The problem of compounding alternators is an old problem, and some American manufacturers make compounded alternators. They use series transformers, convert the alternating current into direct current by means of a commutator and send it into field magnets. The difficulty is that the amount of necessary compounding depends not only on the value of the current, but also on its phase relation. For instance, with the same current output the amount of compounding may be twice as large at a power-factor of 60 per cent as at a power-factor of 100 per cent, while with an ordinary commutator, you always have a compounding proportional to the value of the current, without any reference to its phase relation; and, as I say, the value of all the inventions of Mr. Heyland is in this sifting device by means of which he separates the wattless current from the working component, and succeeds in giving the former component a predominant compounding influence.

With the first arrangement of Heyland's alternator, as described about a year ago, he needed two sets of transformers, because he constructed his first alternator self-exciting and self-compounding. A constant excitation was obtained by means of three transformers connected across the mains, and compounding was obtained by means of a set of series transformers. Then he arranged the secondaries of the transformers so that he needed only three brushes for self-excitation and compounding. He soon found that there was some trouble with the series transformers, because very large currents had to be commutated, connected with the switchboard and back again, and the additional price of these six transformers was very high. I have heard that a few weeks ago he proposed in an article to excite the alternator by means of a direct-current exciter as with usual alternators and only to compound it by means of this commutator. So practically he resigned all his former construction and retained only his commutator, using it for compounding. About a year

ago I had opportunity to speak publicly on this subject, and I insisted then upon this point, namely, that Mr. Heyland would change everything but this device, because it is the underlying idea of his invention; and so I see that he now really uses this device only for compounding. He went even further and proposed to compound not the field-winding of the alternator itself, but the field-winding of the exciter, as as to have this device in the field of the exciter giving more voltage to the exciting machine with an increase of the wattless component of the alternator.

Now, the question is whether those alternators are going to be widely used in practice. I do not know. The question is whether or not customers will be willing to pay an additional cost for the benefit of having a straight-line characteristic, and nobody can predict whether it is going to be adopted or not. To my mind Mr. Heyland has done a great work by showing us that it is indeed possible, by very simple means, to attain a flat characteristic alternator; by this he will certainly induce many other inventors to work in the same direction.

PROFESSOR ADAMS: It may be of interest to put Mr. Karapetoff's explanation in a slightly different way. The current may be looked upon as revolving around the brushes at synchronous velocity. If the motion of the commutator and field-winding is also synchronous, then the direction of the current with respect to that winding will be constant for any given brush position and power-factor. If the position of the brushes is such that the energy current has the same direction as the winding, then the latter will carry only the energy current. If the brushes are shifted 90 electrical degrees, then the winding will carry only the wattless current.

As to the practical value of a device of this kind, it would seem that whereas in small sizes, or in small plants, it may sometimes be very valuable, yet in large central stations, which predominate in this country, the addition of this feature of automatic compounding at all power-factors is an improvement of doubtful value; since, with large units and modern switchboards, one attendant (which is required in every case) can control the pressure in the largest station, since neither the load nor the power-factor change suddenly. Moreover, in most central stations, the real pressure regulation is that of the individual feeders, and no alternator, however automatic in its own regulation, can inherently accomplish the feat of regulating a number of different feeders.

I wish to take this opportunity of expressing my appreciation of the very interesting work done by Mr. Heyland, and my admiration for the ingenuity displayed in his dealings with this difficult problem.

DR. DRYSDALE: I think we all must greatly admire the way in which Mr. Heyland has succeeded in producing a device for compounding alternators, especially when they are subjected to variations both of current and of power-factor, which is unquestionably a very fine achievement, and I must confess that it appears to me that it is important, both for convenience and for security, in stations running at such high outputs as we now have. I had the pleasure of seeing a small machine of this type running before I left England, and there could be no question that the working of the machine was very satisfactory indeed, both on non-

inductive and on lagging loads. But when it comes to a question of practical working I can quite believe that there must be a great deal of difficulty, because at the present day with alternators it is no use talking of small machines. We must have machines as a rule of something of the order of 1000 kw or more. Now, that means, with engine speeds as we have them at present, that we must have something like 60 to 70 poles, and when we come to apply Mr. Heyland's device to a machine with that number of poles, the complexity and extra cost must be high. I know it has been employed with a machine of a very large number of poles. I do not know that we have the data as to the extra cost involved. It appears to me, however, that the device mentioned by the first speaker, of applying the compounding arrangements to the exciter, may get over that difficulty very considerably, and I hope we shall hear more of this device in the future, as I regard it with very great interest. Where it seems to me that Mr. Heyland's device, as we have hitherto heard of it, has a more legitimate application, is in turbine-driven machines, where the number of poles is very small, and there it appears to me the extra complication involved would be so small as to justify its use. I do not think there will be any question that, although in the central station this device may not be absolutely necessary, yet it would be of very great assistance to the security of running if the machines could be trusted to regulate themselves throughout without attention.

CHAIRMAN RUSHMORE: I think myself it is often a source of great regret that interesting inventions are not always the best thing commercially. My feeling in the matter has always been that the compounding of an alternator, when it was effected in the machine itself, is a very expensive way of getting at it. It is often quite effective, and was even in the early machines, but there are devices to be had now which will regulate the voltage in any desirable way for a flat compounding or over compounding, which are comparatively inexpensive for large alternators, and which are altogether outside of the machine, and the cost of the machine is very much less.

If there is no further discussion on this paper, we will proceed to the paper by Mr. H. M. Hobart, one of the few men who has been an actual designer and is now also becoming an author. Mr. Hobart's paper is on "Design of Induction Motors," and Professor Ryan has kindly consented to abstract it.

PROF. RYAN: I am indeed glad to perform for the eminent author of this paper the small service that one can do for him at this time, to present for him an abstract of this paper.

A METHOD OF DESIGNING INDUCTION MOTORS.

BY H. M. HOBART.

In the design of dynamoelectric machinery, the term "output coefficient" has been employed by Esson and by Kapp, and is generally denoted by the symbol ϕ .

$$\phi = \frac{W}{D^2 \times \lambda g \times R}$$

where:

W = Rated output in watts.

D = Diameter at the "air-gap" in centimeters. (For an induction motor, D is the diameter of the rotor.)

λg = Gross core length in centimeters.

R = Rated speed in revolutions per minute. (In induction motor designing, it is convenient to neglect the slip, and take for R the synchronous speed.)

The coefficient ϕ has been chiefly employed in the design of continuous-current dynamos and motors, and the writer has found it of extremely limited utility because commutation limits lead to a very wide range of attainable values, depending chiefly upon the rated speed, voltage and output. Similarly in alternating current generators, the required voltage regulation imposes limitations. Where, however, as in the case of synchronous motors and induction motors, heating should generally be the limit of output, ϕ becomes very useful to the designer, and the attainable value is far more independent of the rated speed, voltage and output, than in the case of commutating machinery and alternating-current generators.

In the writer's practice in designing three-phase squirrel-cage induction motors, he has found the attainable values of ϕ to range from 0.000,9 at 10 horse-power to about 0.001,8 at 10,000 horse-power, thus only doubling in value for a 1000-fold increase in output. It decreases slightly with increasing voltage, increasing periodicity and decreasing speed. But for the purposes of a broad survey of the factors of induction motor design, it will be taken as varying with the output alone, and in accordance with the curve of Fig. 1.

The present investigation will be limited to three-phase squirrel-cage induction motors, primarily for simplicity's sake, but incidentally because this type is believed to possess such sterling merits as to ensure for it a far more extended use than it now enjoys. Where starting torque or variable speed are required, other types of induction motors must be resorted to, if, indeed, it is not generally found preferable to employ continuous-current motors.

The range of this investigation is carried to 10,000 horse-power, for the study of extremes will be generally admitted to be conducive to a clear comprehension of the factors involved, and to a correct employment of these factors in the intermediate cases with which the designer has to deal in his daily work.

The induction motor has, to a certain degree, needlessly incurred the reproach of requiring an unmechanically small air-gap. The writer has on other occasions shown that the importance of a small air-gap has been overestimated and that it may, in fact, aside from its mechanical undesirability, be detrimental from the electro-magnetic standpoint if carried to extremes.¹

In the present investigation, the air-gap will be determined from the following formula, except that in cases where this gives a value less than 0.10 cm, the air-gap will be taken equal to 0.10 cm.

$$\Delta = 0.000,6 \times \sqrt{D \times \lambda g \times V}$$

where

D and λg are quantities already defined.

V = peripheral speed of rotor in meters per second.

Δ = radial depth of air-gap in centimeters.

$T. W. C.$ denotes the total works cost in dollars, and the writer has found by examination of a large number of dynamoelectric machines built by many different manufacturers in several different countries, that

$$T. W. C. = K \times D \times (\lambda g + 0.7\tau)$$

where D and λg are quantities already defined; τ is the polar pitch at the air-gap (i. e., the circumference at the air-gap divided by the number of poles), and K is a factor to which fairly constant values may be assigned for any particular type of dynamoelectric machine.

1. "The Choice of Air-Gap Diameter for Induction Motors", *Elec. World & Engineer*, Jan. 23, 1904. "The Design of Induction Motors, with Examples from Recent European Practice", *Elec. World & Engineer*, April 30, 1904, p. 805.

For three-phase, squirrel-cage induction motors, K varies slowly from 0.15 in small motors, and it would approach 0.27 in a three-phase squirrel-cage motor of 10,000-hp capacity. In the present investigation K will be taken from the curve of Fig. 2. K may be designated the "Cost Coefficient." The product of D and $(\lambda g + 0.7\tau)$ is no such arbitrary quantity as might be thought at first sight. If a winding employs end-connections lying in an extension of the cylindrical surface of the slot portion of the winding, the length over end-connections, which may be denoted by L , is

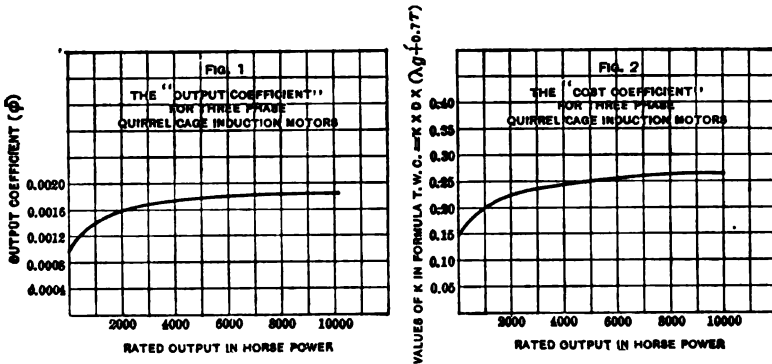

FIGS. 1 AND 2.— CURVES OF OUTPUT AND COST COEFFICIENTS.

approximately equal to $\lambda g + 0.7\tau$. But as the end-connections are arranged in all sorts of shapes in modern machines, and resolve themselves into end-rings in squirrel-cage rotors, a general expression, fairly true for all machines, is obtained by substituting for the "equivalent cylindrical surface," $D \times L$, the expression $D \times (\lambda g + 0.7\tau)$. But the general nature of the product still remains analogous to the cylindrical surface at the air-gap (measured from end to end of the winding), and were K truly constant, it would follow that all machines cost a definite sum per square centimeter of surface at the air-gap, just as, were the heat-emitting facilities the same in all machines, one would take a constant value for the watts lost per square centimeter of surface at the air-gap. As a matter of fact, K varies very slowly indeed, as is evident from the curve in Fig. 2, the values for which are, however, only confirmed through a range of from 10 horse-power to 500 horse-power in motors actually built, and up to 4000 horse-power in projected motors. But as a similar slow rate of rise is known to exist in continuous-current and alternating-current generators, up to 5000

horse-power, it is not unjustifiable to conclude that a growth at an equivalent slow rate is a sound assumption for induction motors.

Now it is believed that the induction motor should, to a greater extent than is at present the practice, be designed for minimum total works cost, as this, throughout a wide range of ratings, also corresponds to excellent technical constants.

We have two formulæ:

$$T.W.C. = K \times D \times (\lambda g + 0.7\tau) \quad (I)$$

and
$$\phi = \frac{W}{D^2 \times \lambda g \times R} \quad (II)$$

Of all possible values of D and λg fulfilling equation (II) for a given value of ϕ , W and R , there is but one D and one λg which make the total works cost a minimum. By a brief calculation it will be readily seen that the equation

$$\lambda g = 2 \times 0.7\tau = 1.4\tau$$

supplies the data corresponding to the minimum total works cost.² The author proposes to take this equation, in conjunction with a suitable value of the output coefficient ϕ , as the ultimate basis for the design of induction motors, and to show that throughout a great range of speeds and outputs, the design arrived at by this means is also a practical and sound design. In any case, it is, of course, necessary in the final instance, to examine the design thus arrived at, as to its properties, and to compare it with designs having a different output coefficient, ϕ , or a different ratio of λg to τ . The

2. Setting equation II in the form

$$\lambda g = \frac{W}{D^2 R \phi}$$

and letting $\tau = K' D$

and substituting these values in equation I, we obtain

$$T. W. C. = K \times D \times \left(\frac{W}{D^2 R \phi} + 0.7 K' D \right)$$

$$\text{or } T. W. C. = K \times \left(\frac{W}{D R \phi} + 0.7 K' D^2 \right).$$

Differentiating and equating to zero, we obtain

$$-\frac{W}{D^2 R \phi} + 2 \times 0.7 \times K' \times D = 0$$

or

$$-\lambda g + 2 \times 0.7 \times \tau = 0$$

or

$$\lambda g = 1.4\tau = 1.4\tau.$$

author has tested this method in many cases, and whilst it may occur that a careful examination leads to employing a different ratio of λg to τ , it must be said that the above method appears to him to afford by far the readiest means for obtaining a practical and economical design.

It is quite natural that several other factors (which have not been considered in the cost formula) should affect the ratio of λg to τ , for instance, very high peripheral speeds would make it desirable, for mechanical reasons, to increase the ratio of λg to τ , whilst very low peripheral speeds would tend to make it preferable to decrease it for thermal reasons. It will also be seen that small variations from the ratio of λg to τ for the minimum cost generally increase the cost but slightly, and this fact must also be kept in mind. To bring the subject within suitable limits the author in this paper confines his study chiefly to the design for minimum total works cost. The dimensions of the design for minimum total works cost may be derived as follows:

We have the condition that

$$\lambda g = 1.4\tau$$

and

$$D^2 \lambda g = \frac{W}{\phi \times R}.$$

We deduce

$$1.4 D^2 \tau = \frac{W}{\phi \times R}.$$

Letting $N =$ Periodicity in cycles per second, we have:

$$D = \frac{120 N \tau}{\pi R} = 38.2 \frac{N \tau}{K}$$

and

$$1.4 \times 1460 \frac{N^2 \tau^2}{R} = \frac{W}{\phi \times R}$$

$$\therefore \tau^2 = 0.00049 \times \frac{W \times R}{\phi \times N^2}$$

$$\tau = 0.079 \sqrt{\frac{W \times R}{\phi \times N^2}}$$

τ is independent of the value assumed for the "cost coefficient," K . W , R and N are in any case given, and ϕ is determined from

the curve of Fig. 1. Thus we may readily determine τ for any given case, then λg (from $\lambda g = 1.4\tau$) and then D , and then the total works cost. In Tables I, II and III, this is done for motors of 10 horse-power, 100 horse-power, 1000 horse-power and 10,000 horse-power, for 12.5, 25 and 50 cycles per second and for a wide range of speeds (numbers of poles).

To set suitable limits to the scope of the present investigation, the author has entered up in the tables only those designs complying with the following three conditions:—

First Condition. Values of not less than 18 cm for the pole pitch, τ . With small values of τ only a small number of slots per pole can be taken, and this deleteriously affects the zig-zag dispersion, quite apart from the fact that with but few slots per pole the "dead-points" become more distinct. Nevertheless, 18 cm must by no means be taken as the smallest pole pitch which it is justifiable to employ in practice. In small motors, still lower values of τ must be taken.

Second Condition. The peripheral speed, V , shall not exceed 40 meters per second. It is, of course, the centrifugal force and not the peripheral speed which is the limiting factor and the peripheral speed is taken here as leading to greater convenience of treatment.

Third Condition. No designs for speeds below 40 r.p.m. are considered, and even these low values are merely used to emphasize the tendencies in extreme cases.

For each motor falling within the assigned limits, the values of R , T , τ , λg , D , V and Δ are recorded in the tables.*

It may be well to go through these steps for the case of the first motor in Table I, a 10-hp, 12.5-cycle, 4-pole motor. From the curve of Fig. 1, we find ϕ to be equal to 0.000,92. $W = 7460$. $R = 375$. $N = 12.5$.

$$\Delta = 0.000,013,7 \frac{7460}{0.00092} = 0.0385 \text{ cm.}$$

3. The expression for Δ may obviously be transformed into

$$\Delta = 0.000,6 \times \sqrt{D \times 1.4\tau \times \frac{D\pi R}{100 \ 60}}$$

and this leads to the simple formula $\Delta = 0.000,013,7 \sqrt{\frac{W}{\phi}}$

As this is below the stipulated amount, Δ is taken equal to 0.1 cm.

$$\tau = 0.079 \sqrt{\frac{7480 \times 375}{0.00092 \times 156}}$$

$$= 0.079 \times 268$$

$$= 21.0 \text{ cm.}$$

$$\lambda g = 1.4\tau = 29.4 \text{ cm.}$$

$$D = \frac{4\tau}{\pi} = 26.8$$

$$V = \frac{2 N \tau}{100} = 5.25 \text{ meters per second.}$$

K , the "cost coefficient" is found from the curve of Fig. 2, to be equal to 0.14

$$T = 0.14 \times 26.8 \times (29.4 + 0.7 \times 21.0)$$

$$= 0.14 \times 26.8 \times 44.1$$

$$= \$165.$$

The other cases in Tables I, II and III are worked out on the same basis, except that the labor is greatly reduced by going from one size to another by means of simple ratios effected by the slide rule.

In these tables are also given values for the "dispersion coefficient," σ , the value of which is of great importance in induction motor design, and for the maximum value of the power factor, which is entered up as $\cos \phi$, according to customary conventions, although, of course, ϕ in this case, is the angle of lag at the motor between terminal voltage and current, and has nothing to do with ϕ the output coefficient. In deducing σ , the method set forth on page 805 of the *Electrical World and Engineer*, for April 30, 1904, has been employed. H , the average number of slots per pole for stator and rotor having been, for simplicity's sake, taken equal to 0.4τ , and this is a fair average working value for rough preliminary calculations, although, of course, the voltage and other considerations must be considered in the final design. It is further assumed that the slots are half-opened. The constants C , C' and C'' , employed in the calculation of σ are defined in the article referred to.

$$\cos \phi = \frac{1}{1 + 2\sigma}$$

But although it is more customary to compare $\cos \phi$ for different designs, a comparison of σ really throws more light on the subject and in the curves, values of σ are employed.

In Figs. 3, 3a, 3b, 4, 4a, 4b, 5, 5a and 5b, the cost of these in-

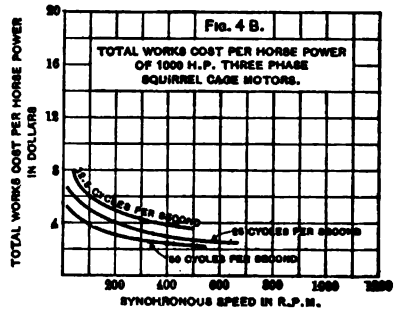
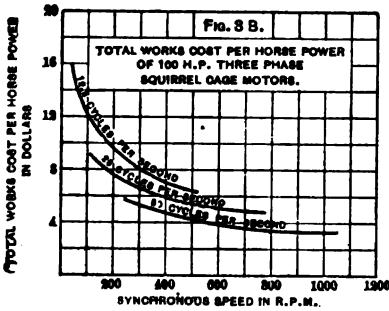
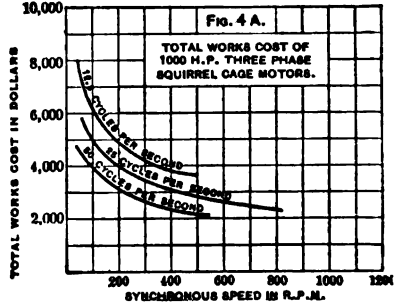
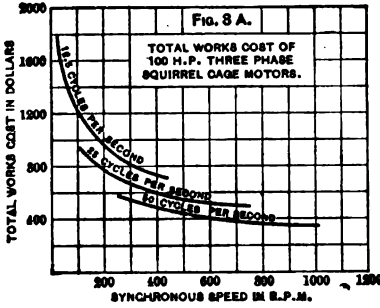
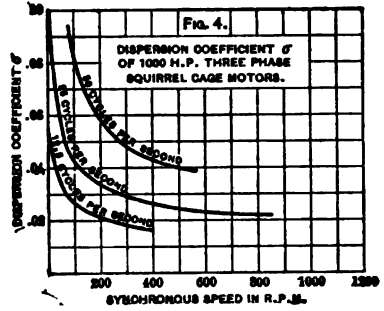
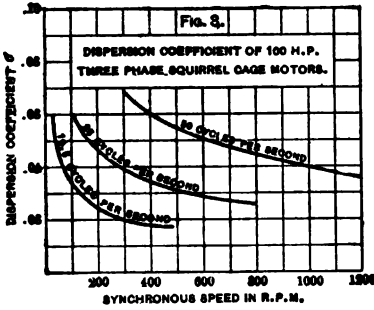

FIGS. 3 AND 4.—RELATION OF COST TO SYNCHRONOUS SPEED.

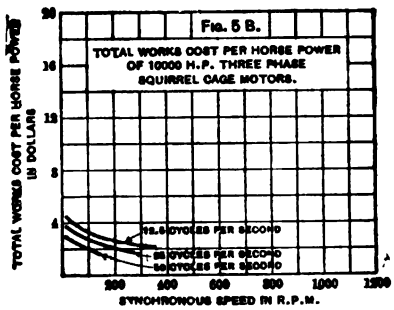
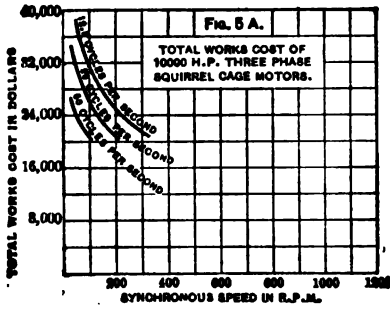
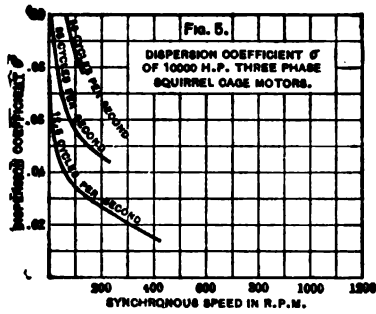
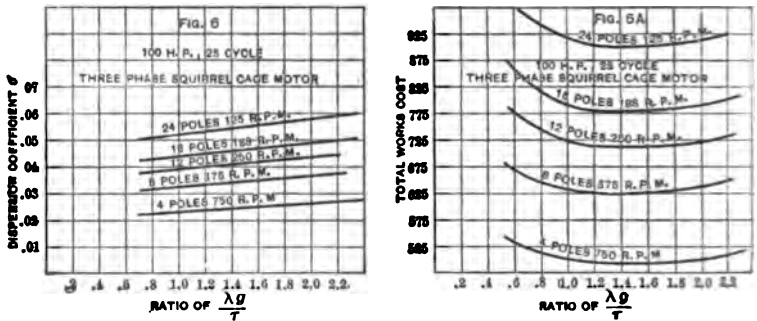

FIG. 5.—RELATION OF COST TO SYNCHRONOUS SPEED.

duction motors and their performance so far as relates to the values of σ have been plotted as functions of the synchronous speed for the designs for 100 horse-power, 1000 horse-power and 10,000 horse-power, and for 12.5, 25 and 50 cycles per second.

The cost and σ curves are placed in parallel columns, to facilitate an understanding of the curves.

One fact is very striking, namely, the lower minimum total works cost and the larger values of σ for motors for a high periodicity. As the author has already pointed out, the "output coefficient" ϕ , has been taken as depending only upon the brake horse-power. It would have been more correct and more in accordance with the present practice to take a slightly higher output coefficient for low periodicities. This would have decreased the cost and slightly increased the dispersion coefficient (σ) of the low frequency, as compared with the high frequency designs.



FIGS. 6 AND 6A.—CURVES OF COST RELATION.

Figs. 6 and 6a, show for the 100-hp, 25-cycle designs, the variation in the total works cost and in σ with variations in the ratio of λg to τ . It is evident from these curves that it is permissible to depart to a considerable extent from the ratio $\frac{\lambda g}{\tau} = 1.4$, as the total works cost will not be increased by any prohibitive amount. On the other hand, we learn from Fig. 6, that the decrease in σ is very slight for a considerable decrease in $\frac{\lambda g}{\tau}$ and hence so far as power factor is concerned, one rapidly reaches undesirable dimensions in

endeavoring to improve the power factor. But especially in small motors, one is for this and other reasons obliged to depart widely from the most favorable ratio, so far as regards minimum cost. In such cases considerably smaller values than the ratio $\frac{\lambda g}{\tau} = 1.4$ are commonly employed. But for all medium sizes and large motors, the method here described affords a ready means of obtaining a good preliminary design.

The investigation is also of interest as indicating the range of rated outputs, speeds and periodicities for which induction motors designed for minimum total works cost also have good technical properties. For ratings within this range, there is additional reason for employing induction motors, especially in those cases where the design of the corresponding continuous-current motors is unfavorable.

TABLE I.
CONSTANTS FOR THREE-PHASE SQUIRREL CAGE INDUCTION MOTORS DESIGNED FOR MINIMUM COST.
12.5 CYCLES PER SECOND.

Number of Poles.	4					6					8					12																						
	R=	T=	$\Delta \times H=$	C=	cost=	R=	T=	$\Delta \times H=$	C=	cost=	R=	T=	$\Delta \times H=$	C=	cost=	R=	T=	$\Delta \times H=$	C=	cost=																		
10 h. p.	875 \$165	81	84	8.4 9.5	.80	950 \$135	18.6	745	7.45 9.5	.915	187.5 \$5,000	66	87.3	14.4 9.5	.965	125 \$1,185	41.8	1.58 9.5	19.5 9.5	.945	195 \$3,700	59.8	88	7.46 9.5	9.5 9.5	.967	125 \$3,700	117.5	47	7.46 9.5	9.5 9.5	.967	125 \$3,700	117.5	47	7.46 9.5	9.5 9.5	.967
100 h. p.	875 \$165	81	84	8.4 9.5	.80	950 \$135	18.6	745	7.45 9.5	.915	187.5 \$5,000	66	87.3	14.4 9.5	.965	125 \$1,185	41.8	1.58 9.5	19.5 9.5	.945	195 \$3,700	59.8	88	7.46 9.5	9.5 9.5	.967	125 \$3,700	117.5	47	7.46 9.5	9.5 9.5	.967	125 \$3,700	117.5	47	7.46 9.5	9.5 9.5	.967
1,000 h. p.	875 \$165	81	84	8.4 9.5	.80	950 \$135	18.6	745	7.45 9.5	.915	187.5 \$5,000	66	87.3	14.4 9.5	.965	125 \$1,185	41.8	1.58 9.5	19.5 9.5	.945	195 \$3,700	59.8	88	7.46 9.5	9.5 9.5	.967	125 \$3,700	117.5	47	7.46 9.5	9.5 9.5	.967	125 \$3,700	117.5	47	7.46 9.5	9.5 9.5	.967
10,000 h. p.	875 \$165	81	84	8.4 9.5	.80	950 \$135	18.6	745	7.45 9.5	.915	187.5 \$5,000	66	87.3	14.4 9.5	.965	125 \$1,185	41.8	1.58 9.5	19.5 9.5	.945	195 \$3,700	59.8	88	7.46 9.5	9.5 9.5	.967	125 \$3,700	117.5	47	7.46 9.5	9.5 9.5	.967	125 \$3,700	117.5	47	7.46 9.5	9.5 9.5	.967

TABLE III.
CONSTANTS FOR THREE-PHASE SQUIRREL CAGE INDUCTION MOTORS DESIGNED FOR MINIMUM COST.
50 CYCLES PER SECOND.

Number of Poles.	4		6		8		12		16		
	10 h. p.	100 h. p.	10 h. p.	100 h. p.	10 h. p.	100 h. p.	10 h. p.	100 h. p.	10 h. p.	100 h. p.	
10 h. p.	R=	1,500	R=	1,040	R=	750	R=	500	R=	375	
	T=	315	T=	362	T=	332	T=	457	T=	497	
	$\Delta \times H=$	1.37	$\Delta \times H=$	1.31	$\Delta \times H=$	1.09	$\Delta \times H=$	0.97	$\Delta \times H=$	0.97	
	C=	26.5	C=	24.9	C=	23.5	C=	19.8	C=	18	
	$C' =$	40	$C' =$	34.8	$C' =$	31.5	$C' =$	27.7	$C' =$	25	
100 h. p.	R=	86.4	R=	47.6	R=	57.3	R=	76	R=	91.5	
	T=	28.5	T=	24.9	T=	22.5	T=	19.8	T=	18	
	$\Delta \times H=$	1.75	$\Delta \times H=$	1.75	$\Delta \times H=$	1.75	$\Delta \times H=$	1.75	$\Delta \times H=$	1.75	
	C=	1081	C=	945	C=	840	C=	76	C=	66	
	$C' =$	12	$C' =$	12	$C' =$	12	$C' =$	18	$C' =$	18	
1,000 h. p.	R=	11.4	R=	9.9	R=	9	R=	7.9	R=	7.9	
	T=	3.7	T=	3.2	T=	2.8	T=	2.5	T=	2.5	
	$\Delta \times H=$	1.37	$\Delta \times H=$	1.31	$\Delta \times H=$	1.09	$\Delta \times H=$	0.97	$\Delta \times H=$	0.97	
	C=	26.5	C=	24.9	C=	23.5	C=	19.8	C=	18	
	$C' =$	40	$C' =$	34.8	$C' =$	31.5	$C' =$	27.7	$C' =$	25	
10,000 h. p.	R=	86.4	R=	47.6	R=	57.3	R=	76	R=	91.5	
	T=	28.5	T=	24.9	T=	22.5	T=	19.8	T=	18	
	$\Delta \times H=$	1.75	$\Delta \times H=$	1.75	$\Delta \times H=$	1.75	$\Delta \times H=$	1.75	$\Delta \times H=$	1.75	
	C=	1081	C=	945	C=	840	C=	76	C=	66	
	$C' =$	12	$C' =$	12	$C' =$	12	$C' =$	18	$C' =$	18	
		cos $\phi =$.945		cos $\phi =$.928		cos $\phi =$.918		cos $\phi =$.900		cos $\phi =$.880	
		$\Delta \times H=$ 4.8		$\Delta \times H=$ 4.8		$\Delta \times H=$ 4.8		$\Delta \times H=$ 4.8		$\Delta \times H=$ 4.8	
		C= 84		C= 84		C= 84		C= 84		C= 84	
		$C' =$ 47.5		$C' =$ 47.5		$C' =$ 47.5		$C' =$ 47.5		$C' =$ 47.5	
		D= 174		D= 174		D= 174		D= 174		D= 174	
		V= 84		V= 84		V= 84		V= 84		V= 84	
		$\Delta =$.83		$\Delta =$.88		$\Delta =$.958		$\Delta =$.988		$\Delta =$.980	

TABLE III - (Continued).

Number of Poles.	34	38	48	78	108					
10 h. p.....					
100 h. p.....					
1,000 h. p.....	$R=260$ $T=22,880$ $\tau=237$ $A_g=41.6$ $D=227$ $V=30.7$ $\Delta=.88$	$H=11.86$ $\Delta \times H=8.75$ $C=9.6$ $C'=67$ $C''=.76$ $\sigma=.061$ $\cos\phi=.910$	$R=196$ $T=23,590$ $\tau=225.6$ $A_g=88$ $D=361$ $V=36.6$ $\Delta=.88$	$H=9.45$ $\Delta \times H=8$ $C=9.6$ $C'=75$ $C''=.75$ $\sigma=.072$ $\cos\phi=.875$	$R=188$ $T=23,190$ $\tau=27$ $A_g=37.8$ $D=275$ $V=27$ $\Delta=.88$	$H=10.8$ $\Delta \times H=8.43$ $C=9.6$ $C'=70$ $C''=.76$ $\sigma=.069$ $\cos\phi=.865$	$R=85.5$ $T=24,190$ $\tau=20.7$ $A_g=89$ $D=278$ $V=30.7$ $\Delta=.88$	$H=8.25$ $\Delta \times H=2.64$ $C=9.6$ $C'=51$ $C''=.75$ $\sigma=.090$ $\cos\phi=.850$	$R=86.8$ $T=23,100$ $\tau=26.5$ $A_g=49.6$ $D=1,260$ $V=36.5$ $\Delta=.88$	$H=14.2$ $\Delta + H=23.5$ $C=9.6$ $C'=70$ $C''=.76$ $\sigma=.114$ $\cos\phi=.800$
10,000 h. p.....					

DISCUSSION.

CHAIRMAN RUSHMORE: Mr. Hobart's paper is now opened for discussion. I think we all owe much to Mr. Hobart. He is one of the few men who are able to look at the subject of designing in a broad way and he has written much about it, where, instead of considering the designing of individual machinery, he gives the principles which govern the design of different lines and types, as he has here. I have gained much from Mr. Hobart, not always by accepting his ideas, but by suggestions which have resulted from them.

The following paper was then read by title, whereupon the Section dissolved after a vote of thanks, by acclamation, to the Chairman and to the Acting Chairman of the Section.

THE COMMUTATION OF DIRECT AND ALTERNATING CURRENTS.

BY PROF. E. ARNOLD AND J. L. LA COUR, *Electrotechnical Institute, Karlsruhe.*

I.

COMMUTATION IN DIRECT-CURRENT MACHINES.

1. THE CLOSED-CIRCUIT DIRECT-CURRENT WINDING.

Nearly all direct-current machines are built nowadays with closed-circuit armature windings. The simplest of these windings is the Pacinotti spiral winding to which every other re-entrant or closed winding may be referred. Fig. 1 shows the two-

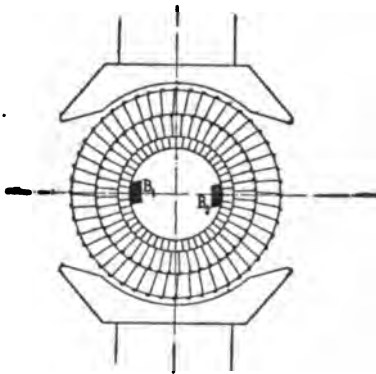

FIG. 1. PACINOTTI RING WINDING.

pole plan of this type of winding. Between the brushes B_1 and B_2 the same number of turns is always included; the e.m.f. induced in each of these turns has the same curve-form as the field. Consequently, for the indicated position of the armature there is induced in each coil a momentary e.m.f., which is determined from

the field-curve, Fig. 2a, by the position of the coils in the field. Since the coils are distributed equally over the armature, a voltage is obtained which is equal to the number of coils times the mean value of the e.m.f. induced in a coil during its movement from brush to brush. If we measure the voltage between one brush, for example, the negative B_1 , and different points of the commutator's surface, and plot these as functions of the position of the respective point on the commutator's surface, we obtain the so-called potential curve of the commutator, Fig. 2b. This may be

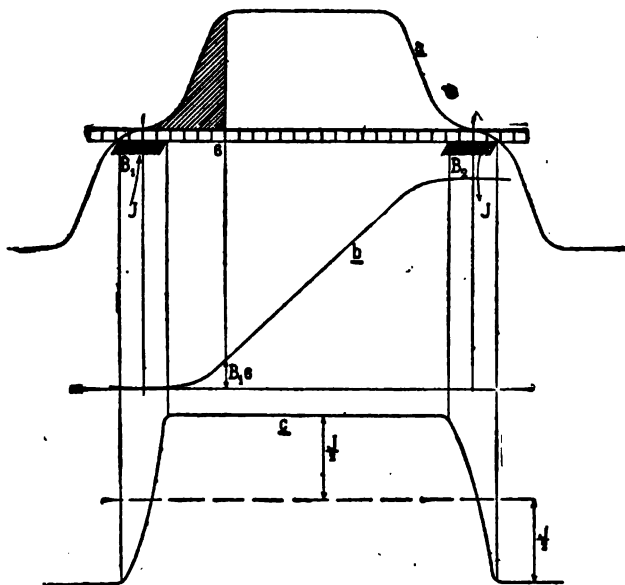

FIG. 2. FIELD POTENTIAL AND CURRENT CURVE OF A CLOSED-CIRCUIT WINDING.

determined from the field-curve, Fig. 2a; for between the brush B_1 and, for example, the lamina 6, a mean e.m.f. is induced, the intensity of which is proportional to the shaded area B_1-6 . The potential curve of the commutator is consequently the summation or integral curve of the field curve. Even if the field curve deviates considerably from a sinusoid, the potential curve, in general, approaches a sinusoid. The brushes B_1 and B_2 stand in the neutral zone of the field and consequently at the vertices of the potential curve.

If a load is put on the direct-current machine, there flows

through both halves of the armature winding a constant current $I/2$; under the brushes the current changes its direction. Hence one obtains for the value of the current in one turn at successive instants the curve, Fig. 2c. This gives at the same time an idea

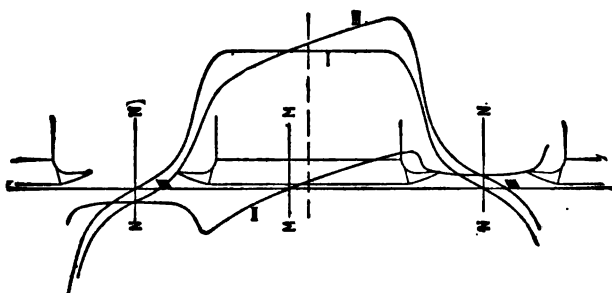

FIG. 3. FIELD CURVES FOR NO-LOAD AND WHEN LOADED.

of the mean current strength in the turns at every point of the armature periphery. The armature current generates, therefore, a fixed field which is superposed upon the field of the magnet system. In Fig. 3, the curve *I* represents the field produced by

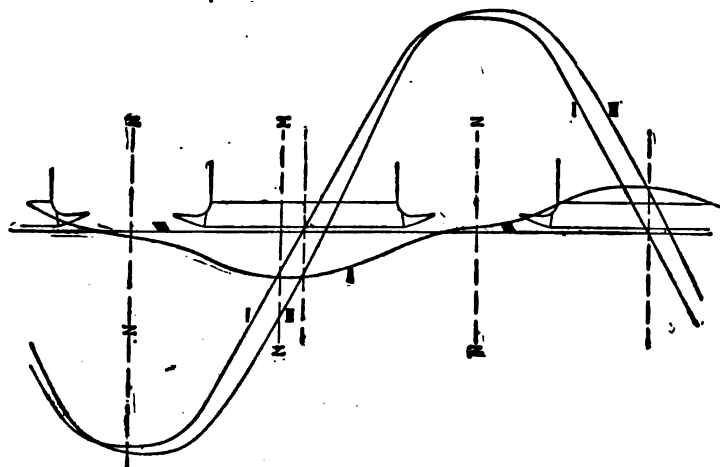

FIG. 4. POTENTIAL CURVES OF COMMUTATOR FOR NO-LOAD AND WHEN LOADED.

the exciting current; curve *II*, the field generated by the armature current, and curve *III*, the resulting field curve. *NN* is the neutral zone of the magnet field and *MM* that of the armature field. In Fig. 4, the curves *I*, *II*, *III* give us the corresponding

potential curves of the commutator. As is seen from Figs. 3 and 4, the field is distorted by the armature current, and the potential curve displaced thereby in the direction of rotation.

If we next consider what happens in and under the brushes, experiments have shown that all points of brushes of like polarity have almost the same potential, even when strong currents of short-circuited coils pass through the brushes. In carbon brushes one can measure between their outermost points voltages of only a few hundredths of a volt. From this it follows that the form of that part of the potential curve which lies under the brushes depends solely on the e.m.f. which is induced in the short-circuited coils. The part of the potential curve which lies under the brushes is consequently developed in the same way as the rest of the potential curve. In Fig. 5 the part of the potential curve lying under the brushes during no load and full load is drawn on an enlarged scale.

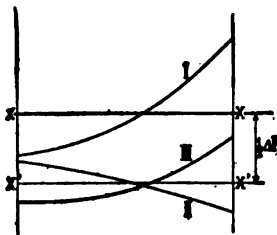

FIG. 5. POTENTIAL CURVE BETWEEN THE NEGATIVE BRUSH OF A GENERATOR AT NO-LOAD (I) AND WHEN LOADED (III).

We have left unmentioned hitherto the influence of the ohmic drop of voltage in the armature winding, on the potential curve. The influence of this decrease is very small, and may moreover be taken into account simply by subtraction from the induced e.m.f. Under the brushes we have at the transition and delivery of the current a drop of voltage, the amount of which depends on the area of brush contact, the properties of the carbons, and on the amount of the load current. While in Fig. 5, curve I, which refers to the armature on no-load, encloses with the axis of abscissæ equally large positive and negative areas, the potential curve III, referred to load, encloses with the axis of abscissæ XX a large negative area. If we draw a horizontal line $X'X'$, with which curve III encloses equally large positive and negative areas, the

difference of this line from the axis of abscissæ is a measure of the decrease of voltage $\frac{1}{2} \Delta P$ under the brushes, which is conditioned by the current delivery. On loading a machine, therefore, two phenomena occur: First, a displacement of the potential curve around the commutator, and, second, an increase of the mean potential difference between the brushes and the commutator. In addition to these main phenomena, there are also minor phenomena, which consist in a deformation of the potential curve under the brushes. These proceed mainly from the currents within the short-circuited coils.

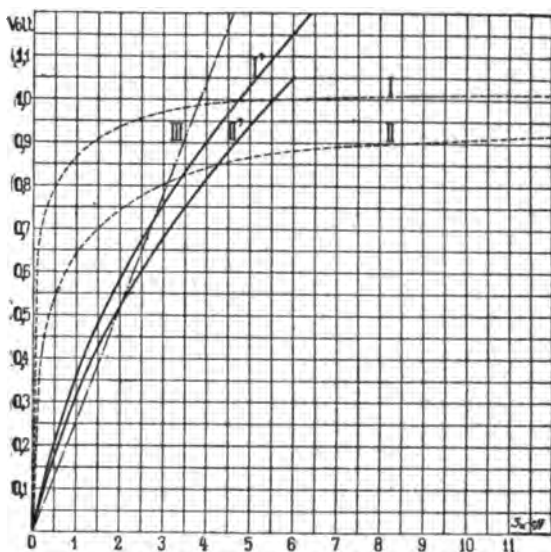

FIG. 6. TRANSITION VOLTAGE BETWEEN CARBON AND COMMUTATOR.

We will now investigate in order the causes of the alteration of the potential curve under the brushes.

2. DROP OF VOLTAGE UNDER THE BRUSHES.

If a direct current is taken from a smooth, rotating collector-ring, one obtains as the relation between the current density and the potential difference between the carbon brushes and the collector-ring, curve I of Fig. 6. It is seen that the voltage at first increases quickly with the strength of the current, and then remains almost constant. The voltage, however, as Doctor Kahn

has shown,¹ depends upon the direction of the current. For the direction of the current metal-carbon, that is, under the positive brushes, the potential difference is greater than for the opposite direction, carbon-metal, that is, under the negative brushes. Curves *I* and *II* show this difference.

If the density of the current is not constant, but varies rapidly, as, for example, when an alternate current is taken from a collector-ring *PD*, curves like *I'* and *II'* of Fig. 6 are obtained. These have also been recorded by Doctor Kahn at the Electrotechnical Institute of Karlsruhe, and indeed with the same carbons and under the same conditions as curves *I* and *II*. There was no appreciable phase displacement between the current and the voltage curves.

The experiments of Doctor Kahn have further proved that the *PD* curve is independent of the frequency, and that it is hardly noticeably influenced by the surface velocity of the ring. If the

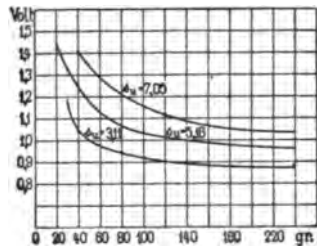

FIG. 7. TRANSITION VOLTAGE BETWEEN CARBON AND COMMUTATOR AS FUNCTION OF THE PRESSURE IN GRAMS PER CM².

ring is allowed to come gradually to rest, the current remains constant at all velocities. As soon as the ring is at rest, the current begins immediately to sink and the *PD* curve *III* of Fig. 6 is obtained.

Curve *III* is a straight line through the origin. It is quite natural that, at rest, the *PD* should increase proportionally to the current strength.

In the rotating collector-ring, the *PD* does not remain proportional to the current, which may partly be traced to changes of temperature at the surface of transition.

1. See "Übergangswiderstand von Kohlenbürsten" by Dr. Max Kahn.

If the collector-ring is heated by means of a flame, the strength of the current, at constant voltage, increases. Also the pressure of the carbons has a considerable influence on the voltage curve. This appears plainly from Fig. 7. Oiling and polishing the collector causes a slight increase in resistance, by which the production of sparks on the commutator can, under some circumstances, be avoided. In general, however, when using carbon brushes, the lubrication of the commutator is not advisable, since it then readily blackens.

In Fig. 8 are given voltage curves for three kinds of carbons manufactured by the firm Le Carbone. These curves have been taken from a commutator at 12 meters-per-second surface velocity. The current was passed through one carbon brush to the commutator, and taken from it through the other. The voltage ΔP is plotted as a function of the effective current-density S_{eff} . Curve *I* refers to hard carbons of Brand *S*, curve *II* to medium

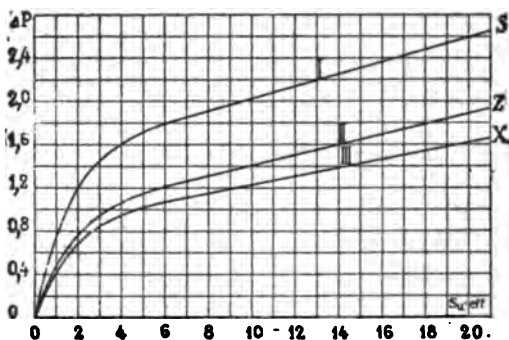

FIG. 8. TRANSITION VOLTAGES OF LE CARBONE CARBONS.

carbons of Brand *Z* and curve *III* to soft carbons of Brand *X*. After the carbons were well started, the strongest current, was sent through them, so that they were thoroughly warmed. Current and voltage with different currents were then recorded in the quickest possible succession. The carbons and the commutator had consequently no time to cool off, and the curves obtained refer to almost the same temperature of contact surfaces.

In Figs. 9 and 10 the voltage curve ΔP for copper and Boudreaux brushes is plotted as a function of the current strength.

The losses in the commutator are composed of the losses from mechanical friction and the losses through the transition of the current. The losses from rubbing are known to be:

$$W_r = 9.81 v_b F_b g \rho \text{ watts.}$$

Where g = pressure in Kg per cm^2 .

ρ = coefficient of friction.

v_s = surface velocity of the collector in m/sec .

F_b = Contact area of all brushes in cm^2 .

For copper brushes:

$g = 0.10$ to 0.13 Kg/cm^2 and $\rho = 0.25$ to 0.3 , and

for carbon brushes:

$g = 0.12$ to 0.15 Kg/cm^2 and $\rho = 0.2$ to 0.3 .

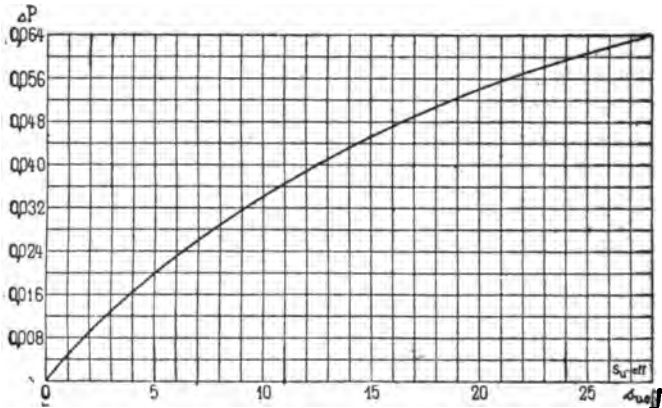

FIG. 9. TRANSITION VOLTAGE FOR COPPER BRUSHES.

Under any one brush the potential varies from point to point. The specific resistance of transition, however, does not vary greatly

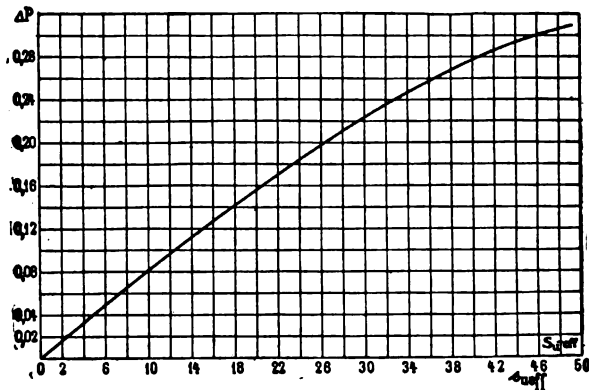

FIG. 10. TRANSITION VOLTAGE FOR BOUDREAUX BRUSHES.

along the width of the brush, for the heating under the brush is uniform. Hence we make no great mistake, if we assume the

specific resistance of transition R_b as constant for the entire brush area. In this case the loss, arising from the transition of the current under the positive and negative brushes becomes

$$W_u = s_{ueff}^2 R_b F_b$$

where s_{ueff} signifies the effective current-density under the brushes. $s_{ueff} R_b$ is the mean potential difference under the brushes and this results from the voltage curves, Fig. 8, as ΔP . Further

$$s_{ueff} = f_u s_u \text{ and } s_u F_b = 2I$$

where s_u signifies the mean current-density under the brushes, f_u is the form factor of the potential curve under the brushes; for this coincides with the curve of current-density under the brushes upon the assumption of a constant specific resistance of transition R_b . It becomes consequently

$$W_u = f_u \Delta P I \text{ watt.}$$

In order to determine the transition loss W_u , one ascertains first the form factor f_u of the potential curve as it occurs for an alternate current, then obtains

$$s_{ueff} = f_u s_u = f_u \frac{2I}{F_b}$$

and concludes from the voltage curve of the respective kind of carbon the voltage ΔP corresponding to this effective current-density.

3. DISPLACEMENT OF THE POTENTIAL CURVE WITH THE LOAD.

By the deformation of the field curve with load, the potential curve, measured around the periphery of the commutator, is displaced. In order to determine the form of the potential curve under the brushes, it is necessary first to determine the field curve for the zone in which the brushes stand. The integral curve of this part of the field curve gives us the form of the potential curve under the brushes.

Let us consider first a smooth armature, Fig. 11, with a simple closed lap-winding. The winding we replace by an equally distributed layer of copper $A-A$ in which the currents flow that produce the current curve, Fig. 12. At no load, the armature current is infinitely small and its magnetizing effect can be neglected. By drawing the representation of the lines of force, Fig. 13, and deducing the flow of force of each line, one obtains in well-known

manner the field curve I , Fig. 3, at no load. At any point X of the upper surface of the armature the intensity of the field is

$$B_o = \frac{AW_i + AW_s - AW_p}{1.6\delta_a} \cdot \frac{b_a}{a_a}$$

Where AW_i = Ampere windings for two air-spaces.

AW_s = Ampere windings for two teeth.

AW_p = Ampere windings for two pole-pieces.

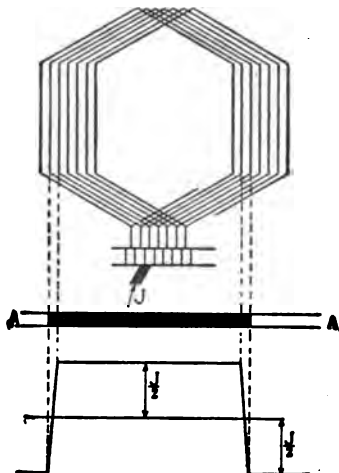

FIGS. 11 AND 12. LOOP-WINDING AND CURRENT CURVE.

From the field curve of the neutral zone, the potential curve results, as shown before, by means of integration. With load, there is superposed upon the no-load field the additional field

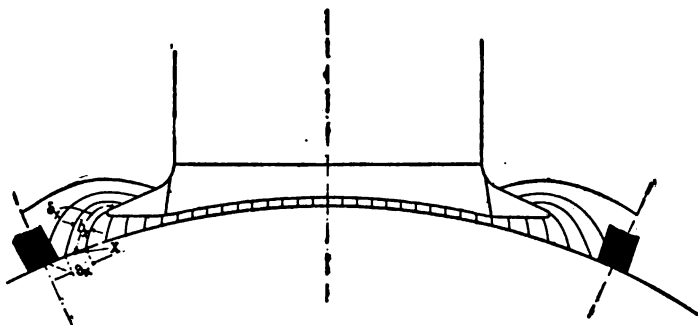

FIG 13. FIELD OF DIRECT-CURRENT SHUNT MACHINE AT NO-LOAD.

which arises when one passes from no load to full load. This field proceeds mainly from the armature current and passes between

the poles approximately as indicated by the lines of force of Fig. 14 A. The lines of force of this plan are replaced by those of Fig. 14 B, which run almost perpendicular to each other. The additional field with load is represented by the field curve II, Fig. 4. At the point X, between the pole-tips, the intensity of the additional field is

$$B_q = \frac{(b_s - b_y) AS - \frac{1}{2} AW_p}{0.8 XZ} + \frac{(\tau - b_s - b_y) AS}{0.8 XY}$$

Where b_s signifies the distance of the middle of the brushes from the neutral zone of the armature field, and b_y the distance of the point X from the middle point of the brushes. This neutral zone

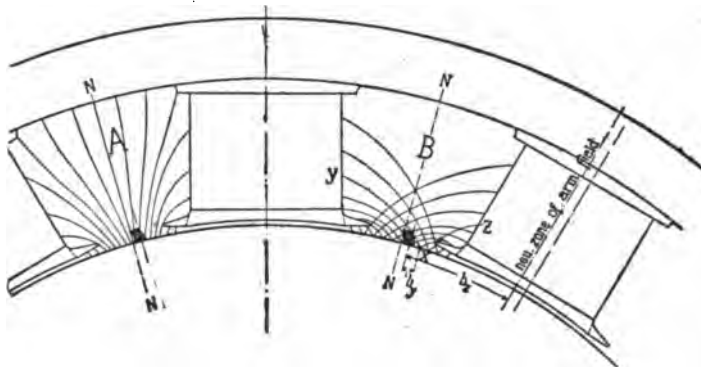

FIG. 14. ARMATURE FIELD OF DIRECT-CURRENT DYNAMO.

of the armature field almost coincides in ordinary pole constructions with the middle point of the magnet core. In the formula for B_q , the relation $\frac{b_s}{a_s} = 1$ is assumed because the tubes of force have an almost constant cross-section.

The intensity of the resulting field with load is now simply

$$B^s = B_o + B_q$$

Curve III of Fig. 4 shows the complete field curve with load. In Fig. 15 that part of the field with load is represented which lies between the pole-tips. Its integral curve gives us the form of the potential curve II in the neutral zone with load; this however is only correct when one neglects some smaller minor phenomena of which we shall speak later.

If the armature winding is imbedded in slots, we obtain with load besides the two fields B_o and B_q another field, whose lines of force pass sideways over the slots. This field changes its direc-

tion when the current is commutated, and induces an e.m.f. in the turns of the respective slots, which e.m.f. also causes a displacement of the potential curve with load.

The current volume per cm periphery of the armature we indicate by AS . If the pitch of the slots is t_1 , then the current volume

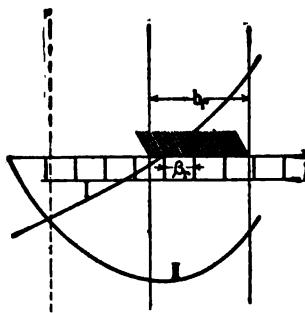

FIG. 15. FIELD AND POTENTIAL CURVE IN THE NEUTRAL ZONE WHEN LOADED.

per slot is $t_1 AS$; this generates per cm length of the armature a slot-field

$$\Phi_N = t_1 AS \lambda_N$$

which changes its direction during commutation. λ_N is the permeance of the slot per cm length of armature core. This change lasts $\frac{t_1 + b_r - \beta_r}{v}$ seconds, where v signifies the surface

velocity of the armature, $b_r = b_1 \frac{D}{D_k}$ is the width of the brushes

reduced to the periphery of the armature and $\beta_r = \beta \frac{D}{D_k}$ the width of the commutator bar reduced to the armature periphery. Consequently, the mean e.m.f. induced by the Φ_N per cm length of the armature conductor is proportional to

$$2 \Phi_N \frac{v}{t_1 + b_r - \beta_r} = 2 AS \lambda_N \frac{vt_1}{t_1 + b_r - \beta_r}$$

An equally large e.m.f. would also induce a constant field on the armature periphery

$$B_N = 2 AS \lambda_N \frac{t_1}{t_1 + b_r - \beta_r}$$

per cm length of the armature conductor. Consequently, one can replace the slot field in its effect by a field intensity B_N opera-

tive on the armature periphery. λ_N is the magnetic permeance per cm length of the slot; this may be reckoned as follows:

1). If the sides of the coils are arranged in two planes above each other, as in Fig. 16, then

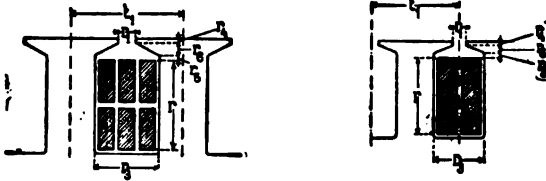

FIGS. 16 AND 17. ARRANGEMENT OF COIL IN THE SLOTS.

$$\lambda_N = 1.25 \left\{ \frac{r}{8r_2} + \frac{r_2}{r_2} + \frac{2r_2}{r_1 + r_2} + \frac{r_1}{r_1} \right\} + 0.92 \log \left(\frac{\pi t_1}{2r_1} \right) + 0.5 \frac{l_2}{l}$$

2). If the sides of the coils are arranged in one plane beside each other, as in Fig. 17, then

$$\lambda_N = 1.25 \left\{ \frac{r}{8r_2} + \frac{r_2}{r_2} + \frac{2r_2}{r_1 + r_2} + \frac{r_1}{r_1} \right\} + 0.92 \log \left(\frac{\pi t_1}{2r_1} \right) + 0.5 \frac{l_2}{l}$$

In these formulæ, l_2 denotes the length of the coil head, i. e., the length of the cross-connection of the armature-bar on one side of the armature, and l the length of armature iron.

If we denote, like B_N , the field intensity of the additional field as B_q

$$B_q = 2 AS \lambda_q$$

then the specific conductivity of the cross-flux at the point of the armature surface which lies opposite the middle point of the brushes becomes

$$\lambda_q = \frac{b_s - \frac{AW_p}{2AS}}{1.6 XZ} + \frac{\tau - b_s}{1.6 XY}$$

Consequently, for a slotted armature, in that part of the neutral zone in which the current is commutated, the effective field intensity with load becomes

$$B_s = B_o + B_q + B_N = B_o + 2 AS \left(\lambda_q + \lambda_N \frac{t_1}{t_1 + b_r - \beta_r} \right)$$

This change from no load to load becomes greater the greater λ_q and λ_N . If we now draw the field curve B_s in the commutating zone, its integral curve gives us the form of the potential curve under the brushes.

It is important also to know the scale of the potential curve and the situation of the curve relative to the brush potential.

If the pitch of the winding is approximately equal to the distance between the centers of poles, the e.m.f. induced in an armature coil with load becomes

$$e_b = \frac{N}{K} l_r v B_p 10^{-8} \text{ volts.}$$

Here N signifies the number of the wires on the armature; K , the number of the commutator bars; l_r , the reduced length of iron of the armature in cm, and v , the surface velocity in m.p.s. As is evident, e_b is proportional to B_p , whence it follows that the field curve I , Fig. 18a, can also be measured in volts. e_b is the e.m.f. induced per commutator-segment. Reducing the width of the commutator bars to the periphery of the armature, the integral curve II , Fig. 18a, of the field curve can also immediately be drawn to a determined volt-scale.

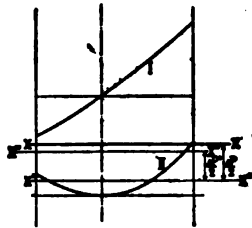
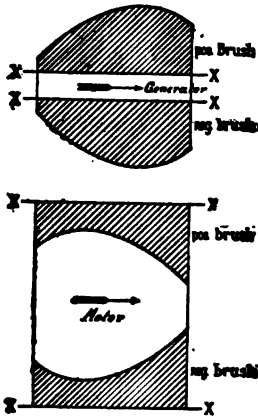

FIG. 18a. POTENTIAL CURVE
BRUSH OF A GENERATOR
UNDER THE NEGATIVE
BRUSH WHEN LOADED.

In Fig. 18a the horizontal line $X'X'$ is then drawn which encloses the equally large positive and negative areas with the potential curve under the brushes. The mean current-density

$e_u = \frac{2I}{F_b}$ indicated in the voltage curve of the respective kind of carbon, gives us a preliminary measure for the drop of voltage ΔP^1 under the brushes. In order to preserve the correct position of the potential curve relative to the brush potential, we draw at a distance $\frac{\Delta P^1}{2}$ from the line $X'X'$ a second horizontal line $X''X''$. In reference to this we calculate the form factor f_u of the potential curve and conclude from the voltage

curve of the carbon, Fig. 8, the drop of voltage $\frac{\Delta P}{s}$ under the brushes corresponding to the effective current density $\int_a s_a$. If we record this in the figure, we obtain the correct axis of abscissae, XX of the potential curve. In Fig. 18b are represented the po-



FIGS. 18b AND 18c. POTENTIAL CURVES UNDER THE BRUSHES OF A GENERATOR AND MOTOR.

tential curves under the positive and negative brushes of a loaded shunt generator, and in Fig. 18c those of a loaded shunt motor.

4. DEFORMATION OF THE POTENTIAL CURVES UNDER THE BRUSHES.

We have hitherto neglected the deformation already mentioned, which proceeds from the currents within the short-circuited coils. In order to understand better these complicated processes, some experiments² ought first to be mentioned, which were performed for the experimental determination of the amount of this deformation.

First experiment. On a 500-volt 65-kw machine of the Gesellschaft für Elektrische Industrie, Karlsruhe, all the brushes were lifted, and the part of the potential curve which lies between the

2. These experiments were performed with great care in the spring of 1903 by R. Aberle and W. Land in the laboratory of the Electrotechnic Institute, Karlsruhe.

poles was recorded. The machine during the experiment was driven by a small motor at the normal speed of 700 revolutions per minute, and normally excited by current from an external source.

The potential curve is represented by the curve *A*, Fig. 19. Next the brushes of all holders were laid on the commutator, and the electrical connection broken between the individual brush holders. The speed of rotation and excitation were kept constant at their previous values. Since the winding was a true wave-winding, no currents could flow in the wires. Only in the short-circuited coils internal currents were developed which

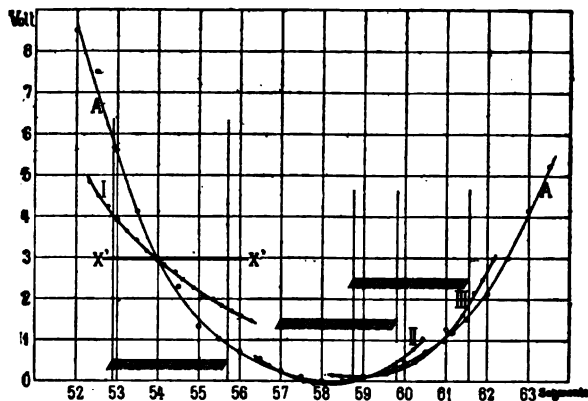

FIG. 19. POTENTIAL CURVE IN NEUTRAL ZONE OF A 65-KW SHUNT MACHINE WITH THE BRUSHES OFF AND ON.

could close their circuits externally through the individual brush-holders. In consequence of these internal currents the potential curve under and near the brushes altered its form. Curves *I*, *II* and *III* of Fig. 19 show the form of the potential curve for three different brush positions. It is to be noted that curves *II* and *III* are recorded near the spark limit. As is evident from these curves, the potential curve is the more deformed the more obliquely runs the part lying under the brushes. Further, it is clear that the potential curve under the brushes is flatter than the curve which was presented for the same place on the commutator with lifted brushes. The potentials diverge the more from each other, as the middle point of the brush is departed from. This effect of the internal currents may be easily explained in the following manner: If we consider the part of the potential curve *A* which lies under the

brushes and draw, Fig. 19, the horizontal line $X'X'$, which with the curve A encloses almost equal positive and negative areas, it is easily seen that the different potentials of the commutator bars cause internal currents to be generated. These currents have their circuits closed through the winding and the carbons as indicated by the arrows of Fig. 20. The system of currents is fixed in space and, therefore, generate a fixed magnetic field. While the armature winding moves through this field, e.m.f.s. are induced in it which produce a deformation of the potential curve.

The potentials which are developed when the brushes are lifted, proceed from the e.m.f. induced in the armature coils. The internal currents which appear on application of the brushes, effect a drop of voltage in the coils, on account of which smaller potential differences are produced between the separate commutator segments. Hence the potential curve is flatter with applied than with lifted brushes. It is also easy to understand that the steeper the potential curve under the brushes is, the greater are the internal currents and the greater the flattening of the potential curve which occurs when the brushes are applied. The deformations, which in general are small, may be graphically and approximately calculated as follows: Considering again the smooth armature, Fig. 20, whose winding is in connection with a commutator having many segments, we first assume that the currents which flow in the connecting parts between the winding and the commutator laminations are proportional to the distance from the middle point of the brushes. The straight line B , Fig. 20, represents then the strength of these currents in the connecting parts. By integration of this, results the curve C , which represents the internal currents, or the additional currents, in the short-circuited coils. These generate a magnetic field, the intensity of which is represented by curve D .

In the short-circuited coils two voltage drops are produced, one coming from the ohmic resistance, and the other from the induced e.m.f. of the field D . The voltage drops originating in the ohmic resistance of the connecting wires, between the winding and the commutator segments, is represented by the curve E , and that arising from the ohmic resistance of armature coils by the curve F . Curve E has the same form as curve B , and, therefore, follows a straight line. Curve F results from curve C by integration. The ordinates of curve F represent therefore the ohmic decrease of

voltage in those armature coils which lie between the middle of the brushes and the point in consideration.

The e.m.fs. induced in the armature coils are proportional to the ordinates of the curve *D*. These forces therefore deform the potential curve under the brushes toward the curve *G*, which is the integral of *D*. If we subtract the ordinates of the

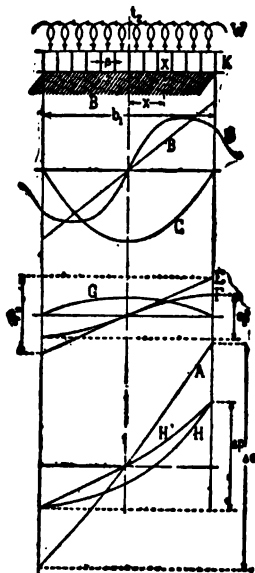

FIG. 20. INFLUENCE OF THE ADDITIONAL CURRENT ON THE POTENTIAL CURVE UNDER THE BRUSH.

curves *E*, *F*, *G* from those of the potential curve *A* with applied brushes we obtain the potential curve *H*, which results when the brushes rest on the commutator. If we had neglected the influence of its own field *D*, when the brushes were applied, one would obtain the curve *H'*, which results from the subtraction of the ordinates of the curves *E* and *F* from those of the curve *A*.

As is evident only the ohmic voltage drops (curves *E* and *F*) cause a flattening of the potential curve under the brushes and hence a lessening of voltage between the brush tips. The e.m.f. proceeding from field *D*, that is, from self-induction, causes on the contrary only a deviation of the curve without diminishing the potential difference between the brush edges. As was clear from

the experiment with the 65-kw direct-current machine, the flattening of the potential curve outweighs the deviation, and since only the flattening causes a diminution of the potential difference between the brush tips we need only take into consideration the ohmic drops of voltage in the short-circuited coils into the calculation of the additional currents.

Through the plane element dF_u , which lies at the distance X (Fig. 20) from the middle point of the brushes, flows a current $s_u \frac{2x}{b_1} dF_u$ into the winding. s_u is the current-density originating from the internal currents under the brush points, which have the distance $\frac{b_1}{2}$ from the middle point of the brush. Consequently there flows through the armature coil, which lies at the distance X from the middle point of the brush, an additional current

$$i_s = \frac{2s_u}{b_1} \int_{x=x}^{x=\frac{b_1}{2}} x dF_u = \frac{2s_u B}{b_1} \int_{x=x}^{x=\frac{b_1}{2}} x dx = \frac{s_u B}{b_1} \left\{ \left(\frac{b_1}{2}\right)^2 - x^2 \right\}$$

In the middle coil appears the greatest additional current.

$$i_{s \text{ max}} = \frac{s_u B b_1}{4} = \frac{s_u F_u}{4}$$

The mean current of all the short-circuited coils become then

$$\begin{aligned} i_{s \text{ mean}} &= \frac{2}{b_1} \int_{x=0}^{x=\frac{b_1}{2}} i_s dx = \frac{2s_u B}{b_1^2} \left\{ \left(\frac{b_1}{2}\right)^2 x - \frac{x^3}{3} \right\}_{x=0}^{x=\frac{b_1}{2}} \\ &= \frac{2s_u B}{b_1^2} \left\{ \frac{b_1^3}{8} - \frac{1}{3} \frac{b_1^3}{8} \right\} = \frac{s_u B b_1}{6} = \frac{s_u F_u}{6} \end{aligned}$$

where $F_u = b_1 B$ signifies the area of all brushes of one holder.

This additional current gives rise to an ohmic drop of voltage e_r^I in the $\frac{b_1}{\beta}$ short-circuited armature coils, it is

$$e_r^I = \frac{s_u F_u}{6} \cdot \frac{b_1}{\beta} R_u$$

where R_u signifies the resistance of one armature coil. In the connections between the commutator and armature-winding there is produced an ohmic drop of voltage equal to

$$\begin{aligned} e_r^{II} &= \frac{\beta}{b_1} F_u s_u \frac{b_1 - \beta}{b_1} 2 R_u = 2 s_u F_u \beta \frac{(b_1 - \beta)}{b_1^2} R_u \\ e_r &= e_r^I + e_r^{II} = s_u F_u \left(\frac{b_1}{6\beta} R_u + \frac{2\beta(b_1 - \beta)}{b_1^2} R_u \right) \end{aligned}$$

From this horizontal downwards e_r , as a function of s_r is plotted, and this function is represented by the straight line AC . This line cuts the voltage curve of the carbon at C , and now we have

$$AD = s_r; BC = \Delta p \text{ and } CD = e_r$$

As is evident from this, $\frac{e_r}{\Delta e}$ becomes smaller, the smaller Δe is, that is the deformation of the potential curve under the brushes in the above experiment becomes less, the smaller Δe is.

In the beginning of this section we made the assumption that the current-density under the brushes flows according to the curve B , Fig. 20. Consequently $\Delta p = s_r R_b$ would be a straight line function H' of the width of the brush b_1 . Experiments show, however, that the curve I , Fig. 19, receives approximately the same curvature as A , and that curve I intersects all the ordinates of A under the brushes in a fixed proportion. This ratio is, as we have deduced for the parts under the brush tips, equal to $\frac{BC}{CD}$ Fig. 21.

So the potential curve I with applied brushes can be ascertained from the potential curve A by multiplying all the ordinates of the latter curve by the ratio $\frac{BC}{BD}$.

To verify this theory and to investigate the influence of different brushes (copper and carbon) on the deformation of the potential curve from a 10-hp shunt-motor of the Gesellschaft für elektrische Industrie, Karlsruhe, the potential curve with lifted brushes, Fig. 22, and with different brushes of copper and carbon was experimentally determined. For each kind of brush the brushes were first inserted in the neutral zone and afterwards displaced to the spark limit both in the direction of rotation and in the opposite direction.

Fig. 23 shows the potential curves upon the application of the very soft carbon brushes and Fig. 24 those when copper brushes are used. No important deformation of the potential curve was produced when the brushes were displaced only as far as the spark limit. This comes mainly from the fact that the machine was built only for low voltage; that the armature coils possessed a small ohmic resistance and that one could displace the brushes only little into the field before they began to spark. Nevertheless one sees that the deformation of the potential curve through additional currents in the short-circuited armature coils can not be very

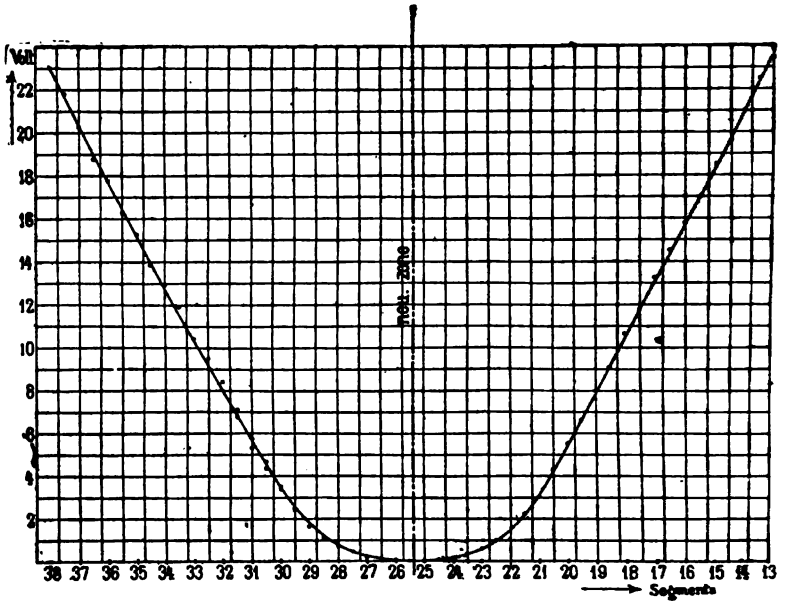

FIG. 22. POTENTIAL CURVE OF 10-HP SHUNT MOTOR IN NEUTRAL ZONE, THE BRUSHES BEING REMOVED.

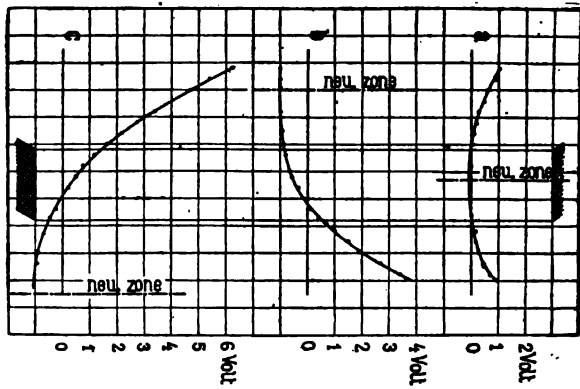

FIG. 23. POTENTIAL CURVE OF 10-HP MOTOR WITH CARBON BRUSHES.

great, when the brushes can only be displaced as far as the spark limit.

5. COMPUTATION AND INVESTIGATION OF THE POTENTIAL CURVE UNDER THE BRUSHES.

After we have investigated the separate influences on the potential curve, let us pass to its computation from the dimensions of a machine.

First, the field B_0 in the neutral zone at light load, the cross-field B_c and the resulting field B' , with load are obtained graphi-

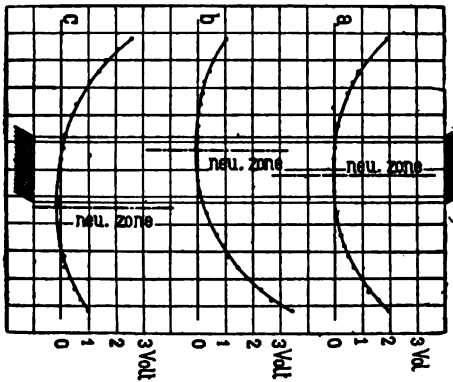

FIG. 24. POTENTIAL CURVE OF 10-HP MOTOR WITH COPPER BRUSHES.

cally in the manner given above. Then the slot field is reckoned reduced to the armature periphery

$$B_N = AS \lambda_N \frac{t_1}{t_1 + b_r - \beta_r}$$

and subtracted from the resulting field with load from which results the field curve B_b , Fig. 25. The integral curve A of this field curve gives us the outline of the potential curve for the case when no internal current flows through the short-circuited coils.

In order to determine the influence of the internal current on the potential curve, we calculate the mean current-density

$s_u = \frac{2I}{F_b}$, the form factor f_u , and conclude from the voltage

curve of the carbon the decrease of voltage under one brush $\frac{\Delta P}{2}$

corresponding to the effective current-density $f_u s_u$. From this results the specific resistance of transition in

$$R_k = \frac{\Delta P}{2 f_u s_u}$$

The potential curve under the brushes gives us the e.m.f. Δe induced between the brush edges; this generates a current in the

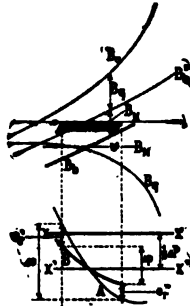

FIG. 25. DETERMINATION OF THE INFLUENCE OF THE ADDITIONAL CURRENT ON THE POTENTIAL CURVE WHEN LOADED.

short-circuited coils which produces an ohmic drop of voltage. At the brush tips we have

$$\Delta e = \Delta p + e_r = 2 s_u R_k + s_u F_u \left(\frac{b_1}{6 \beta} R_u + \frac{2 \beta (b_1 - \beta)}{b_1^2} R_v \right)$$

$$\text{Hence } \frac{\Delta p}{\Delta e} = \frac{2 R_k}{2 R_k + F_u \left(\frac{b_1}{6 \beta} R_u + \frac{2 \beta (b_1 - \beta)}{b_1^2} R_v \right)}$$

We diminish now all the ordinates of the potential in respect to the axis of abscissae $X'X'$ in the ratio $\frac{\Delta p}{\Delta e}$, compute again the form factor f_u and the decrease of voltage $\frac{1}{2} \Delta P$ and draw the correct axis of abscissas XX for the potential curve.

From the potential curve under the brushes, the current in the short-circuited coils may be obtained as the authors have shown.³ Further we have mentioned that the resistance of transition

3. E. Arnold, "Direct-Current Machines," Vol. 1, page 370.

the commutation without being obliged to load them completely. This can be done in the following way very simply. One records the potential curve under the brush at light load and normal voltage, and on short-circuit with normal current. By superposing these curves one obtains a potential curve, which varies little from that with load. This is easily explicable.⁴ In the short-circuited generator a field arises which does not differ much from the cross-field of the loaded machine. The slot-field is on short-circuit, also the same as with load. Hence it follows that the field

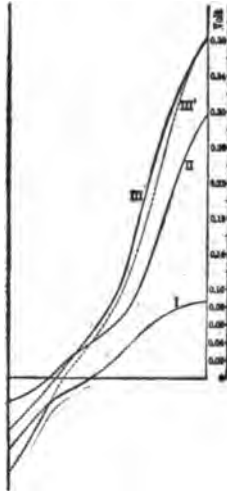

FIG. 27. POTENTIAL CURVES UNDER THE BRUSHES AT NO-LOAD, FOR SHORT-CIRCUIT AND WHEN LOADED.

curve with load results approximately from the field curves on no-load and on short-circuit.

The same is true, of course, for the potential curves, if we disregard their deformation under the brushes. This deformation, as shown above, is not great, and would influence all curves correspondingly, if the specific resistance of transition R_s were constant for all curves.

In the potential curves (Figs. 27 and 28), which were recorded

4. See J. L. la Cour, "Leerlauf und Kurzschlussversuch in Theorie und Praxis."

by Mr. K. Czeija at the Electrotechnic Institute in Karlsruhe, curves *I* represent the potential curves at no load, curves *II* those with short-circuit, curves *III* those with load under the brushes, while curves *III'* result from superposition of curves *I* and *II*. The curves in Fig. 27 were recorded from a machine with copper brushes, and those of Fig. 28 from one with carbon brushes.

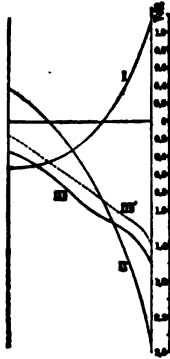

FIG. 28. POTENTIAL CURVES BELOW THE BRUSHES AT NO-LOAD, FOR SHORT-CIRCUIT AND WHEN LOADED.

Since the slot-field and the internal currents of the short-circuited coils at short-circuit are greater than with load, where a commutating field is present, the commutation proves itself more unfavorable on short-circuit than at full load. In general, direct-current machines under load will commute the normal current with displacement of the brushes, if in the same position on short-circuit they can commute two-thirds of the normal current. Consequently, if a machine is to carry 50 per cent overload without brush displacement or formation of sparks on the commutator, it must be able to commute the full-load current on short-circuit, without sparking, and with the same position of the brushes.

6. FIRST CONDITION FOR GOOD COMMUTATION.

It is evident from the foregoing that the steeper the gradient of the potential curve under a brush, the greater are the additional currents which are produced in the short-circuited coils. These currents must disappear at the cessation of the commutation and without giving rise to sparks. The smaller these currents can

be kept, the more favorably the commutation will occur. If the brushes are applied at the magnetic neutral zone (taking into account the slot field) the potential curve under the brushes will run almost horizontal, and only small additional currents will be produced in the short-circuited coils. But since the neutral zone is displaced with load, and the brushes can not be shifted for every change in the load, it is necessary so to proportion a direct-current machine that the potential curve under the brushes will not become too steep at any load. The slope of the potential curve depends principally on the e.m.f. which is induced between the segments of the commutator lying under the brush points. This e.m.f. changes from light load to full load approximately as follows:

$$\frac{b_1 p}{\beta a} (e_b - e_o) =$$

$$\frac{b_1 p N}{\beta a K} l v (B_b - B_o) 10^{-8} = \frac{b_1 p N}{\beta a K} l v (B_q + B_N) 10^{-8} \text{ volt.}$$

If we insert the brushes so that the e.m.f. disappears at half load, at light load and full load, it will become numerically the same and equal to half the difference of the induced e.m.f. at no load and full load. Hence,

$$\Delta e = \frac{1}{2} \frac{b_1 p N}{\beta a K} l v (B_q + B_N) 10^{-8} \text{ volt,}$$

or substituting

$$B_q + B_N = 2 AS \left(\lambda_q + \lambda_N \frac{t_1}{t_1 + b_r - \beta_r} \right)$$

the maximum e.m.f. which is induced in the segments under the brushes becomes

$$\Delta e = \frac{b_1 p N}{\beta a K} l v AS \left(\lambda_q + \lambda_N \frac{t_1}{t_1 + b_r - \beta_r} \right) 10^{-8} \text{ volt.}$$

From the calculation of a large number of high-speed machines, which worked perfectly with respect to commutation, e.m.f.s. resulted as high as 7.5 volts. It is, however, not advisable to make Δe greater than 5 volts if one wishes to be certain that the machine will commute faultlessly. As the first condition for a good commutation, we obtain, consequently,

$$\Delta e = \frac{b_1 p N}{\beta a K} b_s v AS \left(\lambda_q + \lambda_N \frac{t_1}{t_1 + b_r - \beta_r} \right) 10^{-8} < 5 \text{ volt (I.}$$

In motors which are to operate in both directions, one is compelled to insert the brushes in the geometrical neutral zone so

that Δe disappears at light load. Under load in this case the maximum e.m.f. between the brush points becomes

$$\Delta e = \frac{b_1}{\beta} \frac{p}{a} \frac{N}{K} l_i v \pm AS \left(\lambda_q + \lambda_N \frac{i_1}{i_1 + b_r - \beta} \right) 10^{-8} \text{ volt } (I_s)$$

and this may not exceed the value of about 7.5 volts.

7. ADDITIONAL CURRENTS IN THE SHORT-CIRCUITED COILS.

The danger of sparking at the brushes is not due to the e.m.f. Δe itself, but to the additional current i_s generated by it. Hence, it is wrong to speak of a spark voltage between brush and commutator above which the formation of sparks is unavoidable. Not voltages, but only energy, can cause sparks. The voltage of reactance calculated by Parshall and Hobart is an e.m.f. which is proportional to

$$\frac{N}{K} l_i v AS \lambda_N \frac{b_1}{\beta}$$

and, consequently, stands in a certain relation to Δe . In the voltage of reactance, the slot field is not correctly considered and the armature field entirely neglected; so that this formula can be used as an empirical criterion only in the comparison of similarly built machines.

In order to be able to judge a machine in respect to its commutation in a reliable manner, it is necessary first to determine the additional current in the short-circuited coils, and the energy which is liberated when this current disappears. As an additional current we have termed that part of the current in the short-circuited coils, which proceeds from the potential differences between the commutator segments under the brushes. In the case of a potential curve under the brushes, which runs in a horizontal line, the additional current thus disappears. In this case, also, the short-circuited current curve follows a straight line, because the current in the short-circuited coils results through integration of the potential curve. Hence, it follows that the additional current⁵ in the short-circuited coils is proportional to the divergence of the short-circuited current from the current which corresponds to a straight line. The extraneous current may consequently be determined by integration of the potential current under the brushes, if we calculate the ordinates of the axis of abscissae $X'X'$. On both sides of this axis lie equally large positive and negative areas.

5. See E. Arnold, "Direct-Current Machines," Vol. 1.

Since it is necessary first to determine the potential curve and then its additional current, and since only the maximum value of the additional current is of consequence, an approximate calculation will suffice.

Both at no load and full load, where the danger of sparking is greatest, the potential curve under the brushes runs very obliquely and may be approximately replaced by a straight line. For this case the assumption which we made on page 819 for the additional current is exact, and becomes

$$i_{s \max} = \frac{e_s F_u}{4}$$

and since $e_s = \frac{\Delta e}{2 R_k + F_u \left(\frac{b_1 p}{6 \beta a} R_s + \frac{2 \beta (b_1 - \beta)}{b_1^2} R_v \right)}$

and so with the assumption of a straight potential curve, and disregarding the e.m.f. of self-induction of the addition current

$$i_{s \max} = \frac{\Delta e}{\frac{8 R_k}{F_u} + \frac{2 b_1 p}{3 \beta a} R_s + 8 \frac{\beta (b_1 - \beta)}{b_1^2} R_v}$$

This formula holds, however, only with the assumption that we have as many sets of brushes $2p$ as branches of armature current $2a$. If this is not the case, as is possible with wave-windings, in the formula for $i_{s \max}$, $\frac{8 R_k a}{F_u p_1}$ must be substituted in place of $\frac{8 R_k}{F_u}$

and $\frac{8 \beta a (b_1 p_1 - \beta a)}{b_1^2 p_1^2} R_v$ in place of $\frac{8 \beta (b_1 - \beta)}{b_1^2} R_v$, where where p_1 indicates the number of sets of brushes of the same polarity. This change is most simply effected by referring a wave winding to the corresponding Pacinotti ring winding. Then, the general formula for the maximum additional current of the short-circuited coils of a series armature winding

$$i_{s \max} = \frac{\Delta e}{\frac{8 R_k a}{F_u p_1} + \frac{2 b_1 p}{3 \beta a} R_s + \frac{8 \beta a (b_1 p_1 - \beta a)}{b_1^2 p_1^2} R_v}$$

8. INFLUENCE OF SELF-INDUCTION OF A SHORT-CIRCUITED COIL ON THE ADDITIONAL CURRENT.

In order to investigate the influence of self-induction on the extraneous current, let us consider first the simple case in which the e.m.f. Δe generating the additional current is constant during

commutation. This will, of course, never be the case in direct-current machines. In alternating-current commutator machines this case occurs, and, since it may be most easily investigated, both by computation and experimentally, we will begin with this.

According to Kirchoff's law, one obtains for every short-circuited coil the voltage equation

$$\Delta e - S \frac{di_s}{dt} - r i_s = 0$$

S is the apparent coefficient of self-induction, or, as it can be called, the coefficient of the stray induction of a short-circuited coil; r is the resistance of the circuit of the current under observation, and i_s is the additional current. Both S and r vary from time to time. The variation of S , however, is small and can be calculated only with difficulty, wherefore we use for S in the above equation a mean value; r , on the other hand, varies within very wide limits. Thus,

$$r = R_s + 2 R_v + \frac{R_b}{F_u} T \left(\frac{1}{t} + \frac{1}{T-t} \right)$$

where T = time-duration of the short circuit in seconds, and t = time in seconds, counted from the beginning of the short circuit. We first consider two instants of time—

1). i_s at a maximum and $t = t_m$

hence $\frac{di_s}{dt} = 0$

$$\text{and } \Delta e = r i_{s, \max} = i_{s, \max} \left\{ R_s + 2 R_v + \frac{R_b}{F_u} T \left(\frac{1}{t_m} + \frac{1}{T-t_m} \right) \right\}$$

$$\text{hence } i_{s, \max} = \frac{\Delta e}{\frac{R_b}{F_u} \left(\frac{T}{t_m} + \frac{T}{T-t_m} \right) + R_s + 2 R_v}$$

The chief question is how large is t_m ? This time may only be determined by a solution of the differential equation, and, as the computation shows, is almost entirely dependent on $\frac{R_b T}{F_u S}$. Since these computations are very long, let us satisfy ourselves here with giving their result. Curve *I*, Fig. 29, represents the ratio $\frac{t_m}{T}$ as a function of the constants $A = \frac{R_b T}{F_u S}$. For $A = 0$, that is, the specific resistance of transition $R = 0$ becomes i_s , a maximum

on cessation of the commutation, that is, for $\frac{t_m}{T} = 1$. If R_s and, therefore, also, A are very large, i_s becomes a maximum when $\frac{t_m}{T} = 0.5$. As is evident, curve *I* begins at 1 and approaches asymptotically the value 0.5 for very large values of A . From curve *I* the quantity $\frac{T}{t_m} + \frac{T}{T-t_m} = k_t$ has been computed and plotted in curve *II* as a function of A . For large values of A , curve *II* approaches asymptotically the value 4. By means of

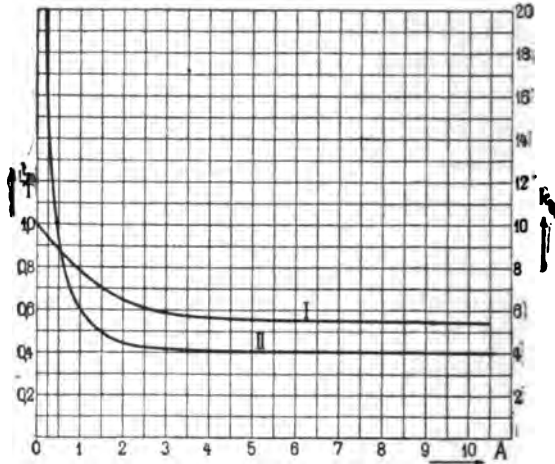

FIG. 29. CURVES FOR DETERMINING THE MOMENT OF THE MAXIMUM VALUE OF THE ADDITIONAL CURRENT.

curve *II*, the maximum additional current may be calculated in a simple manner:

$$i_{s\max} = \frac{\Delta e}{k_t \frac{R_k}{F_u} + R_s + 2 R_v}$$

2). When t is almost equal to T , that is, close to the limit of commutation.

Since $S \frac{di_s}{dt}$ at the disappearance of the current is a negative quantity, the differential equation must, therefore, be possible if

$$ri_s > S \frac{di_s}{dt}$$

The resistance r is determined by a series of factors of which the factor $\frac{R_b}{F_*} \frac{T}{T-t}$ outweighs all others. Neglecting the minor factors, we obtain

$$\frac{R_b}{F_*} \frac{T}{T-t} i_s > S \frac{di_s}{dt} = S \frac{i_s}{T-t}$$

This condition states that *the e.m.f. of the stray induction of the additional current at the instant $t=T$ must be less than the potential difference generated by the additional current between the brush points and the passing commutator segments. If this is not the case there will be sparking.* The equation of the above condition may be written as follows:

$$A = \frac{R_b T}{F_* S} > 1$$

At the moment of the cessation of the commutation, the current density s_s , originating in the additional current, is a maximum.

$$\text{Thus, } r \cdot i_s = R_b \cdot s_{s(t=T)}$$

$$\text{and since } S \frac{di_s}{dt(t=T)} = - \frac{r \cdot i_{s(t=T)}}{A}$$

$$\text{therefore } R_b s_{s(t=T)} = \frac{\Delta e}{1 - \frac{1}{A}}$$

The voltage between the brush tip and the passing segment therefore increases at the disappearance of the current and the more rapidly the smaller A is. Of course, this voltage can not become infinitely great, which ought to be the case according to the above formula. Hence, this formula is not to be taken rigorously nor, likewise the condition $A > 1$. This is owing to the fact that between the brush tip and the passing segment processes occur which make every analytical computation impossible. In order to study these processes we have carried out a series of experiments which correspond exactly to the above-mentioned case.⁶

A storage battery A_s of constant voltage, about 10 volts, was introduced into the circuit, Fig. 30. This consisted of a known resistance R_1 , a self-induction S , and of a commutator K , which served for a periodic opening and breaking of the current. As a commutator was employed, an ordinary direct-current commutator of about 20 cms diameter with 120 copper segments, which were

⁶ These experiments were performed by Mr. H. Hallo and W. Land in the laboratory of the Electrotechnic Institute, Karlsruhe.

insulated from each other by mica, every 4 successive laminations were joined in a group and connected in series. Of the 30 groups thus formed every other one was connected with a sliding ring, which served for the reception of the current. The remaining groups were connected with a second sliding ring. Now, with commutator in rotation, by means of a Duddell oscillograph, the curves of the current and the voltage between brush and commutator were recorded. The current and voltage wires (strips) of the oscillograph are marked in the plan *a* and *b*. In order

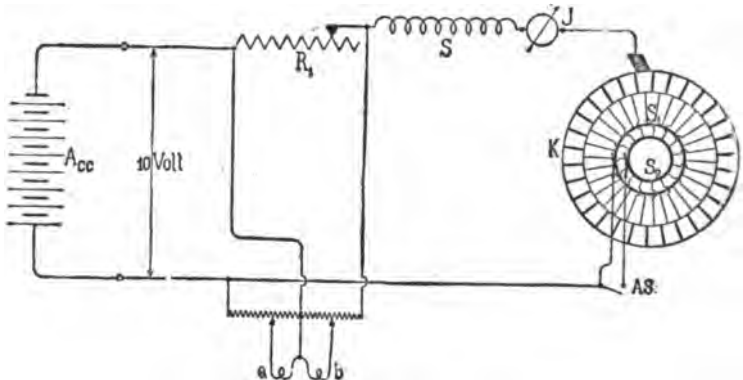

FIG. 30. ARRANGEMENT OF TEST FOR DETERMINING THE ADDITIONAL CURRENT.

to fix the scale of the curves directly on the oscillograms, after the record of the curves of current and voltage, the two rings S_1 and S_2 were connected by closing the switch AS . The current through the brush then became constant and a horizontal line was obtained on the oscillogram. In order to get the voltage scale, the commutator at rest was so placed that the circuit was broken; the horizontal line, which was obtained in the oscillogram for this case, corresponds, consequently, to the 10-volt pressure of the storage battery. With this arrangement, which corresponds to the case observed above, $\Delta e = \text{constant}$, experiments were performed with different velocities of the commutator with resistances R_1 , self-induction S and different carbon brushes. In the following only the characteristic ones will be given:

The oscillograms, Figs. 31 to 35, were all recorded with soft carbon brushes, Brand X, of the firm "Carbone." The total length of the 3 brushes was $B = 6.6$ cm, and their width in sur-

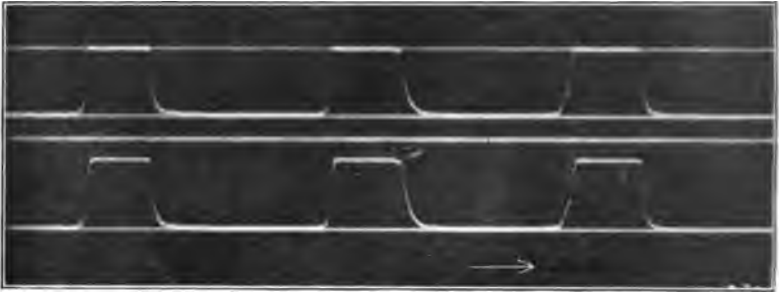

FIG. 31A.

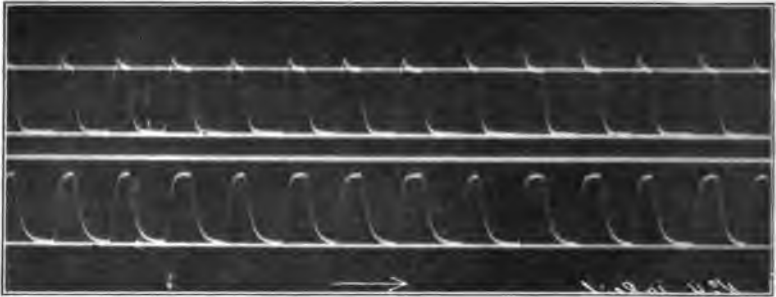

FIG. 32A.



FIG. 33A.

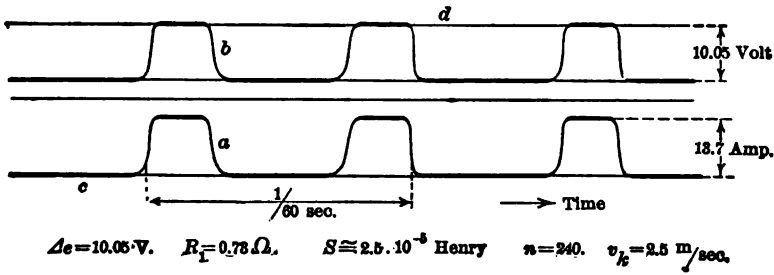

FIG. 31. NO SPARKS WHATEVER.

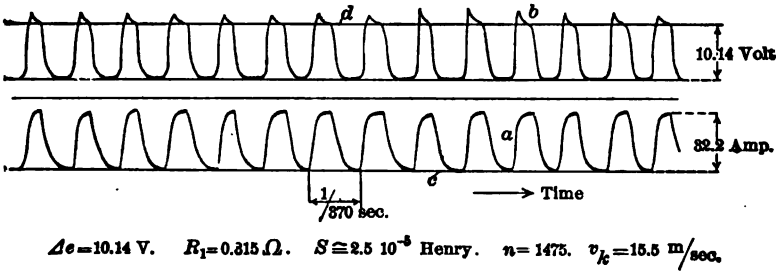

FIG. 32. VERY SLIGHT SPARKING.

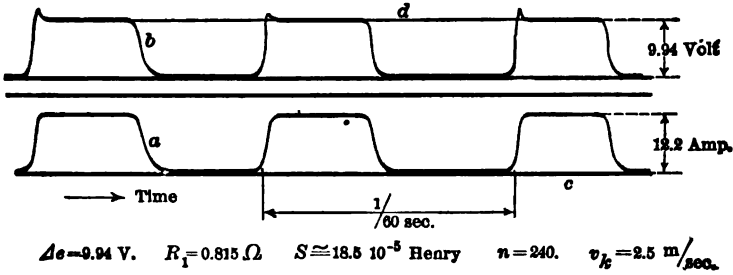

FIG. 33. SLIGHT SPARKING.

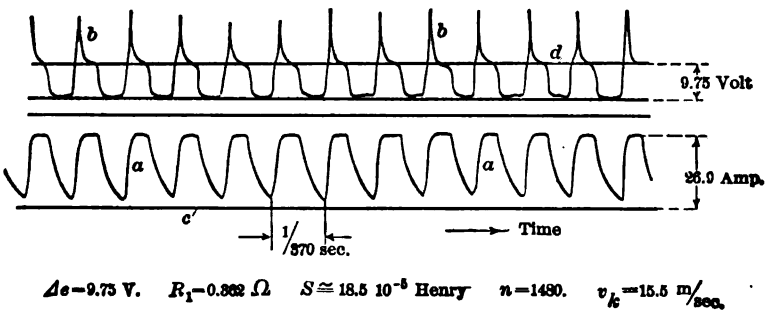
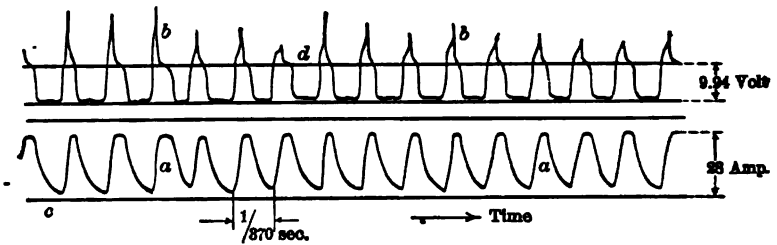

FIG. 34. VERY STRONG SPARKING.

face direction of the commutator $b_1 = 1.4$ cm. Each group of 4 laminations had a width of $\beta = 4 \frac{\pi 20}{120} = 2.09$ cm. Speeds of rotation from 200 to 1500 r.p.m., corresponding to surface velocities of 2.1 to 15.7 m.p.s., were employed.

In the oscillograms, the current curves are marked *a*, the voltage curves *b*, the scale lines for the current *c*, and those for the voltage *d*. The voltage curves are directed upward, and the current curves downward, in order that the two curves may not fall on one another and obscure the oscillogram. Thus the voltages are plotted in the positive direction of the ordinate axis and the currents in the negative direction.

If we continued the current curve in the direction of time, this rises first from zero, according to an exponential curve, but before the current has completely reached its maximum it is forced to disappear. With small self-inductions and small surface velocities the disappearance of the current takes place, also, according to an



$$\Delta e = 0.94 \text{ V.} \quad R_1 = 0.336 \Omega \quad S \approx 18.5 \cdot 10^{-3} \text{ Henry} \quad n = 1470. \quad v_n = 15.4 \text{ m/sec.}$$

Fig. 35.

exponential curve. With large self-inductions and surface velocities, on the contrary, in which the breaking of the current is accompanied by sparks, the curve, according to which the current disappears, is quite deformed. This appears plainly from the oscillograms.

Concerning the voltage curve *b*, this runs horizontal as long as the current is nil. When the current begins to increase, the voltage between brush and commutator sinks slightly, owing to the drop of voltage in the inserted resistance R_1 . If the current disappears, the voltage again increases rapidly and, with large self-inductions, passes beyond the limits of the impressed voltage. The two oscillograms, Figs. 34 and 35, were recorded under almost

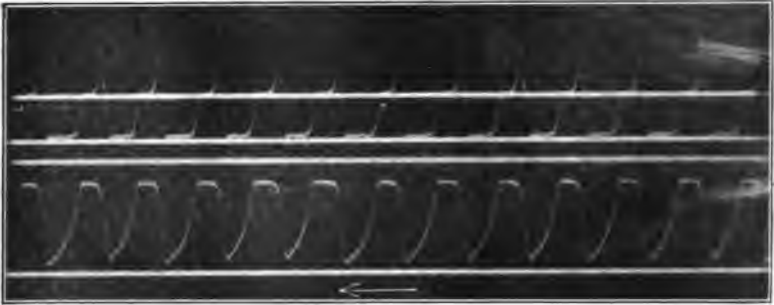

FIG. 34A.

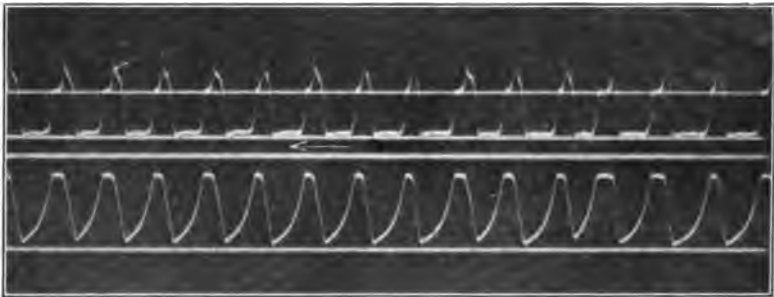

FIG. 35A.

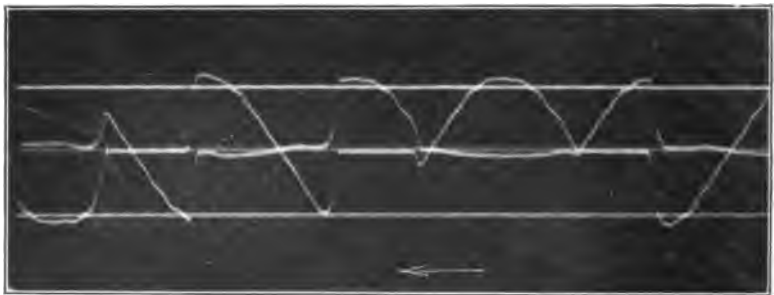

FIG. 47A.

the same conditions. However, the tips of the voltage curve, at the moment of opening, show a somewhat different character. This is caused only by the processes which at the moment of delivery take place at the brush points.

As is evident, the voltage at the moment of opening can rise to 2.7 times the amount of the impressed voltage. Since these excesses of voltage originate in the released energy, it is obvious that this voltage is the direct cause of the spark formation.

9. THE ENERGY RELEASED AT THE DISAPPEARANCE OF THE ADDITIONAL CURRENT.

At the disappearance of the additional current the electromagnetic energy $\frac{1}{2} i_{s, \max}^2 S$ is released; this can be transformed neither into mechanical nor chemical energy; it must, therefore, pass over into heat. This occurs naturally at the place where the current is broken, that is, under the brush tips. When this release of energy is either excessive, or occurs too rapidly, sparks occur. Often, the carbon points even glow. As is evident from the oscillograms, the increase and disappearance of the extraneous current is dependent, in great measure, on the amount of the self-induction of the circuit. The greater the self-induction, the shorter must be the time in which current must disappear. Since the electromagnetic energy, moreover, is proportional to the self-induction, it is easily seen that the self-induction S plays an important part in reference to the sparking.

This influence we will now state by a formula established on an experimental basis. The resistance of the whole circuit is composed of two parts, of which one $R_1 = (R_s + 2 R_w)$ is constant, and the other $R_2 = \frac{R_k}{F_u} \left(\frac{T}{t} + \frac{T}{T-t} \right)$ is variable. Let

us assume at first that the self-induction is $S=0$, and that

$R_2 = \frac{R_k}{F_u} \times \frac{T}{T-t}$ can be fixed, then the current will disappear

according to the curve, Fig. 36, where i_s is plotted as a function of time. If we draw the tangent to the point O , it cuts the line $i_{s, \max}$ at a point A , which corresponds to the moment of time in which the variable resistance R_2 is equal to the constant resistance R_1 . As is evident from the curve, Fig. 36, the current now gradually decreases to this time C . From the point B , however, it

returns very quickly to nil. If now a self-induction is inserted in the circuit, the points *A* and *C* ought to be displaced theoretically toward the right. This, in practice, is not the case, for there are produced at the opening moment very small, often scarcely visible sparks, which give the current time to disappear.

Since the sparks depend not only on the maximum performance of the released energy, which momentarily comes into effect under the brushes, but, also, on how long this energy is effective, it is no simple problem to determine the spark limits of a machine. This depends not only on the electric quantities of the machine, but, also, on the cooling of the brush tips.

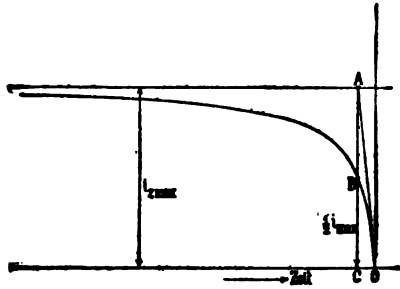

FIG. 36. CURVE ACCORDING TO WHICH THE ADDITIONAL CURRENT DISAPPEARS WHEN $S=C$.

By experiments we have found that the sparking is approximately inversely proportional to the time *OC*, Fig. 36, which, from the moment when the resistance of transition R_x under the brush tip is equal to the constant resistance R_1 of the circuit, extends to the complete disappearance of current. This time results from the equation

$$\frac{R_b}{XB} = R_1$$

where *B* signifies the length of all brushes of one holder, and *X* the part of the passing commutator segment, which at the time *C* is still covered by the brush. Thus,

$$X = \frac{R_b}{BR_1}$$

and the time T_a of cutting out of circuit which is a standard for the sparking, becomes, therefore, equal to

$$T_a = \frac{X}{100 v_b} = \frac{R_b}{100 BR_1 v_b} \text{ seconds,}$$

where v_k represents the surface velocity of the commutator in n.p.s. That this time is a standard for the sparking seems probable, also, from the oscillograms. Since the sparking, moreover, must be proportional to the energy released per cm length of the brushes, we obtain as a critical quantity for the sparking

$$F = \frac{i_{z \max}^2 S}{2 T_a B} = \frac{50 i_{z \max}^2 S v_k R_1}{R_2}$$

F is the energy which is released per cm length of the brushes when the maximum additional current $i_{z \max}$ disappears in the time T_a . Here T_a is the time which elapses from the moment when the variable resistance R_2 is equal to the constant resistance R_1 until the cessation of the current.

With the experimental arrangement represented in Fig. 30 several series of experiments were performed in the following manner in order to determine the amount of F , at which an inadmissible sparking is produced. With one and the same self-induction, the speeds of rotation with different currents were ascertained at which the sparking on the brush tips was still so slight that it could be termed harmless and admissible. The current was changed by changing the resistance R_1 . With each kind of carbon this investigation was carried out at four different values of self-induction S . Since such experiments rest on personal views of what can be considered as admissible sparking, we will give only briefly what results our experiments produced.

For $F = 75$ watts, the sparking was still admissible, but if we increased the surface velocity v_k , without any change in the circuit, the sparking increased and finally became so great that the commutator in a short time was lightly corroded. With very small currents the remarkable phenomenon appeared that the brushes, at a surface velocity of 8 or 9 m.p.s., began to spark, only to cease at about 12m to 15 m. Therefore, if we put down $F \leq 50$ watts, one can be fairly certain that the commutation will run free of sparks.

10. COMPUTATION OF THE COEFFICIENT OF STRAY INDUCTION S IN DIRECT-CURRENT MACHINES.

The coefficient of stray induction S , in absolute units, is measured by the number of linkages of lines of force which the conductors of the coils form with that flow of force which is gen-

erated by a 10-ampere current, when the neighboring armature coils are short-circuited through the brushes.

As stated above, the coefficient of stray induction varies with the time; but we are interested only in the coefficient for the moment at which the short-circuited coil opens the short circuit. At this moment the remaining short-circuited coil sides lie either in the same or in the next slot. In both cases the coils exercise a damping influence on the flow of force generated by the coil under consideration. This damping is the more vigorous, the nearer the coil lies to the other short-circuited coils. If two coil sides per slot issue from the short circuit at the same time, of which one is short-circuited by the positive and the other by the negative brush, the stray induction is twice as great as when only one coil side per slot issues from the short circuit. We calculate most unfavorably, and, hence, most safely, when we assume that all short-circuited coils up to two lie in the neighboring slot. For this case we can set the conductivity of a coil side per cm length of the slot = $k_s \lambda_N$ or $2 k_s \lambda_N$ according as one or two coil sides per slot open the short circuit at the same time. The latter

is the case with diameter windings with $\frac{K}{2p}$ equal to a whole

number. k_s is a coefficient smaller than 1, which has reference to the damping through neighboring short-circuited and massive bodies of metal. This factor is smaller, the more massive are the copper rods which lie beside each other in the groove and the more quickly the additional current disappears. To compute the factor k_s is very difficult. It can only be obtained approximately correct by experiment.

By using the same notation as above, the coefficient of stray induction becomes

$$S = (1 \text{ or } 2) \left(\frac{N}{K} \right)^2 \frac{k_s \lambda_N l_s}{2 \cdot 10^9} \text{ Henry}$$

according as one or two coil sides per slot issue at the same moment from the short circuit.

11. SECOND AND THIRD CONDITIONS FOR GOOD COMMUTATION.

If we collect all that has been stated hitherto in respect to the short-circuited coils of a direct-current machine, we obtain the following conditions which must be fulfilled if the additional

current at the opening moment is not to give rise to the formation of sparks.

First, there must be the constant $A > 1$, in order that the current disappear early enough and not by means of a spark, even if this is very small. In the expression for A appears the specific resistance of transition between carbon and commutator. Since this resistance varies greatly with the density of the current, and secondly at the appearance of sparks very high values can be assumed, and since further the contact under the brushes does not need to be irreproachable, the condition $A > 1$ is not absolutely a standard for the spark limit. It may be asserted, however, that the commutation takes place the more favorably the greater this constant A . Thus it ought to be:

$$A = \frac{R_k T}{F_u S} = \frac{R_k}{100 BS v_s} > 1 \tag{II}$$

As is evident, this condition is sooner met the harder the carbon used and the more slender all brushes are per holder. Further, the coefficient of stray induction S and the surface velocity v_s of the commutator must be as small as possible.

The maximum additional current was calculated with the assumption of a straight potential curve and the neglect of the e.m.f. of stray induction. If we take into consideration the stray induction, the maximum additional current appears later, and, consequently, in the equation the first term $8 \frac{R_k a}{F_u p_1}$ in the denominator should be replaced by the term $\frac{2 k_1 R_k a}{B b_1 p_1}$

Thus, we obtain the following expression for the maximum additional current in the short-circuited coil of a direct-current machine, if the potential curve under the brush approximately follows a straight line:

$$i_{s,max} = \frac{\Delta e}{\frac{2 k_1 R_k a}{B b_1 p_1} + \frac{2 b_1 p}{3 \beta_{11}} R_s + 8 \frac{a \beta (b_1 p_1 - \beta a)}{b_1^2 p_1^2}} R_s$$

In order that no harmful sparks may be produced, the mean energy which is released during the disappearance of the additional current per cm length of a brush should not exceed 50 watts. This energy amounted above, for the case when the constant resistance R_1 was considerably greater than the smallest variable resistance R_s to $\frac{i_{s,max}^2 S}{2 T_s B}$. T_s is the time which elapses from the

moment when the variable resistance R_v is equal to the constant resistance R_1 until the cessation of the current.

Since in direct-current machines the constant resistance

$$R_1 = \frac{2 b_1 p}{3 \beta a} R_v + 8 \frac{\beta a (b_1 p_1 - \beta a)}{b_1^2 p_1^2} R_v$$

is ordinarily much smaller than the smallest variable resistance R_v , the time T_a almost always vanishes, and we must reckon our spark energy in a different way.

Since the variable resistance R_v in direct-current machines is very great in proportion to R_1 , we work with the additional current almost always on the section OB , Fig. 36, and the additional current must change gradually during the entire time of short circuit. Therefore, we calculate best in direct-current machines the mean electromagnetic energy F_m , which is released per cm length of the brush. While the commutator moves forward about one segment, that is, during the time $\frac{\beta}{100 v_k}$ there are released $2 p \frac{i_s^2 \max S}{2}$ joules, and these distribute themselves over $2 p_1 B$ cm length of brush. Hence, the mean spark energy is

$$F_m = \frac{2 p}{2 p_1} \frac{i_s^2 \max S}{2 B \beta} \frac{100 v_k}{1} = 50 \frac{p}{p_1} \frac{i_s^2 \max S v_k}{B \beta}$$

Since this ought to be smaller than 50 watts,

$$\frac{F_m}{50} = \frac{p i_s^2 \max S v_k}{p_1 B \beta} \leq 1 \text{ Watt} \quad (\text{III})$$

For the extreme case that the variable resistance should become

$$\frac{2 k_t R_k a}{B b_1 p_1} < R_1 = \frac{2 b_1 p}{3 \beta a} R_v + 8 \frac{a \beta (b_1 p_1 - \beta a)}{b_1^2 p_1^2} R_v$$

the following equation can be used as the condition for good commutation:

$$\frac{F}{50} = \frac{p i_s^2 \max S v_k R_1}{p_1 R_k} \leq 1 \text{ Watt} \quad (\text{III}_a)$$

These conditions are met sooner the smaller are the additional current $i_s \max$, the coefficient of stray induction S , and the surface velocity v_k on the commutator. The additional current $i_s \max$ becomes smaller the harder are the brushes and the greater the resistances R_v of the connecting wires between armature winding and commutator. The resistance R_v of the armature coils may

not be increased in order to improve the commutation, because then the armature gets too hot and the degree of efficiency of the motor too poor. This is true, also, in part, of the resistances R_v .

12. DESIGN OF DIRECT-CURRENT MACHINES TO OBTAIN GOOD COMMUTATION.

As the first condition for good commutation, we have found that the e.m.f., which is induced between the laminations lying under the brush tips, should be as small as possible. This e.m.f. is induced by the armature field and the slot field.

a). In order to keep this e.m.f. as small as possible it is necessary to make the slot field and the armature field in the commu-

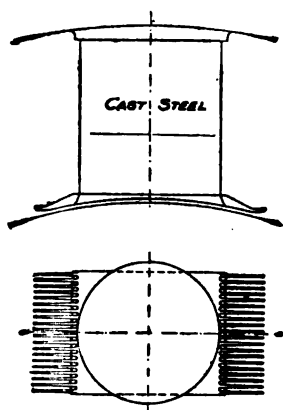

FIG. 37. CAST-STEEL POLE
OF GANZ & CO.

tating zone as small as possible. The first is brought about by constructing the slots relatively wide and not too deep. In order to make the armature field small, the pole-tips and the armature teeth ought to be so far saturated as may be made compatible with expense of the copper on the field. In Figs. 37 to 39 are represented three typical pole constructions.

b). In order to compensate the e.m.f. Δe completely, it is necessary to induce in the short-circuited coils an e.m.f. which is equal and opposite in direction to the e.m.f. induced by the slot field and the armature field. This can be effected according to the proposal of Menges (D.R.P. 34465, 1884) by placing the brushes in the neutral zone and disposing between the main poles

auxiliary or compensating poles excited by the armature current, see Fig. 40. The necessary ampere turns of these compensating

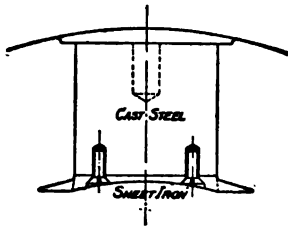

FIG. 38. CAST-STEEL POLE WITH SCREWED-ON LAMINATED POLE-SHOES.

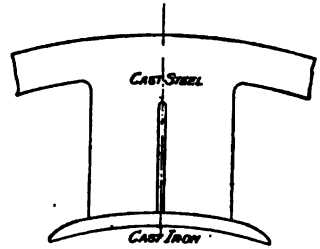

FIG. 39. CAST-STEEL POLE WITH SCREWED-ON CAST IRON POLE-SHOES.

poles are calculated in the same way as those of the main poles. For reversing the current the necessary field is

$$B_N = 2 AS \cdot \lambda_N \frac{t_1}{t_1 + b_r - \beta_r}$$

This field must be provided in the commutating zone under the compensating poles. Since the field is requisite only in the commutating zone itself, and since the coil sides are not equally distributed over the armature periphery, but are concentrated in slots,

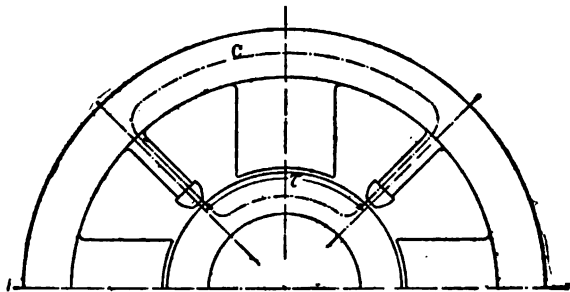

FIG. 40. DIRECT-CURRENT MACHINE WITH COMMUTATION POLES.

the width of the compensating poles, in view of the lateral stray field, is best made somewhat smaller than $t_1 + b_r - \beta_r$, because the current in one slot is commutated over so wide a zone.

First the ampere-turns, $A W_k^1$ per circuit, are calculated which are necessary to drive the flux

$$B_N l_t (t_1 + b_r - \beta_r) = 2 t_1 AS \lambda_N$$

through the magnetic circuit C , of the compensating pole. To these are then added the total ampere-turns of the armature $\tau \cdot AS$ per pair of poles which influence the same circuit. For two commutating poles we obtain, therefore, a number of ampere-turns

$$A W_a = A W_b^1 + \tau AS$$

where τ signifies the distance between pole centers. Hence, it follows that all compensating poles receive a larger number of ampere-turns than the armature. It is necessary to observe that the length of winding is much less than that of the main pole, and that the number of ampere-turns of the main pole becomes smaller, because the brushes stand in the geometrically neutral zone and the demagnetizing effect of the armature on the main pole is, therefore, equal to zero. The compensating poles, however, make necessary a greater expenditure of copper, and it should be applied where it is necessary, as, for example, in Turbo-generators, in generators for sub-stations which commutate the full current at widely differ-

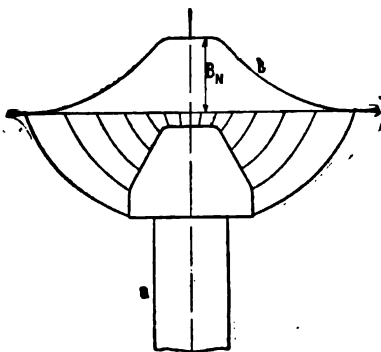

FIG. 41. COMMUTATION POLE AND ITS FIELD.

ent voltages, and in shunt-motors for speed regulations within wide limits. If the favorable influence of the saturation of the teeth on commutation be departed from, a machine with this kind of compensating poles should commutate equally well on short circuit as under load.

Regarding the form of the pole shoes of the compensating poles, the best form is that shown in Fig. 41. The speed with which the current per slot is commutated should be greatest when the middle of the slot stands opposite the middle of the brush. The form of pole-shoe a in Fig. 41 furnishes the gradually increasing

and decreasing field b shown in the figure, which is necessary for a rectilinear curve of short-circuit current.

c). The large number of ampere-turns of the compensating pole is avoided if, in the neutral zone, small U-shaped electromagnets are applied (according to a proposal made by Swinburne in 1890), which are excited by the armature current. When the brushes lie under the electromagnet B , Fig. 42, projecting in the direction of rotation, the windings of the latter have a magnetic effect as indicated by the arrows, and by which, at the same time, a partial com-

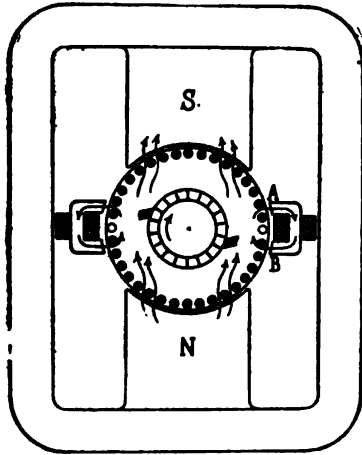

FIG. 42. ARRANGEMENT OF SWINBURNE COMMUTATION POLES.

pounding is obtained. The constructive arrangement of the electromagnets in the neutral zone causes difficulties, because these auxiliary poles may not come too near the pole-points, in order that the leakage of the magnet field and the armature field shall not become too great.

d). In the compound machines installed by Johnson-Lundell, the compound winding is wound as usual around the whole magnet core; an air-space, however, is left through the middle of the core and gives the pole-shoe such a form that, even with no load, one-half cd of the magnet core on the trailing side, Fig. 43, is completely saturated. ($B = 17,000$, say), while the induction in the second half ab is much smaller ($B = 10,000$, say). If the machine is heavily loaded, the armature current endeavors to distort the field, which is pos-

sible only on one-half the field on the leading side, because the part cd of the magnet core is strongly saturated. The compound winding is chosen of such power that it magnetizes the half ab of the magnet core and one gets almost the same field curve with light load as with full load; so that the armature field and, therefore, λ_q becomes infinitely small. By a well-chosen form of pole corner on the leading side, the form of the field curve in the commutating zone can be made very flat. Although the com-

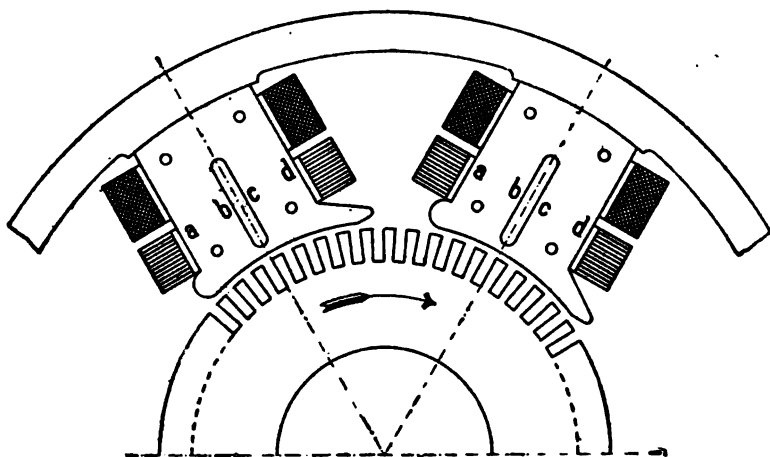

FIG. 43. POLE CONSTRUCTION AND COMPOUND WINDING FOR OBTAINING A STABLE COMMUTATION FIELD.

pound winding must be chosen of great strength, the ratio $\frac{\text{field ampere turns}}{\text{armature ampere turns}}$

can be brought down close to 1. The degree of efficiency of the machine becomes rather high, therefore, at the lesser loads, because the excitation needs little energy.

e). In the machine of Déri, as it is now installed, not only the necessary commutating field is provided, but even the entire armature field is done away with. For this purpose Déri arranges, beside the shunt winding N , around the pole, a compensating winding K , Fig. 44, on the main pole P , which is provided (as was proposed and carried out by Ryan) with auxiliary poles excited by the armature current and situated in the neutral zone. This machine is expensive and demands a very exact setting of the brushes.

f). Both in machines with lap-winding, as in machines with symmetrical wave-winding, it is desirable to install equi-potential connections, because they remove any want of symmetry in the different fields and commutating zones. All multifold multiple wave-windings are symmetrical, as well as all single wave-windings in which the number of poles is divisible by the number of the branches of the armature current.⁷

g). In all machines the number of commutator segments K is preferably such as is not divisible by the number of poles, because

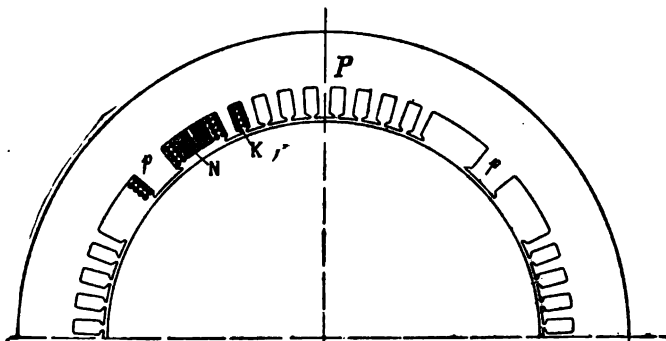

FIG. 44. ARRANGEMENT OF FIELD WITH DERI COMPENSATION WINDING.

then two coil sides per slot do not simultaneously leave the short circuit. If $\frac{K}{2p}$ is a whole number, as must be the case with parallel armatures having equi-potential connections, the simultaneous exit of two coil sides from short circuit may be avoided by displacing every second brush a trifle in the direction of the rotation of the commutator.

II.

13. THE SINGLE-PHASE CONVERTER.

With the assumption of a sine-shaped field curve, the potential curve of the commutator of a single-phase converter with no load is a sine curve whose vertex coincides with the neutral zone between the poles. With load this potential curve persists almost unaltered, because the m.m.f. of the watt current and of the generated direct current work against each other, so that no cross-field is

7. See E. Arnold, "Die Gleichstrom Maschine." Bd. I, Seite 60.

produced. Under the brushes, which stand at the vertices of the potential curve, the potential curve is, however, somewhat deformed with load, because e.m.f.s. are induced in the coils short-circuited by the brushes on account of the change of direction of the slot field. If we indicate the alternating current led into an armature coil by

$$i = I \sqrt{2} \sin (\omega t - \Psi + \alpha)$$

at the moment of commutation this is

$$i_0 = i_t = i_0 = I \sqrt{2} \sin (\alpha - \Psi)$$

During commutation this strength of current changes only little, while the direct current generated changes from

$$+ \frac{I_g}{2} \omega t - \frac{I_g}{2}$$

If the width of the brushes in the direction of the commutator surface is b_1 , τ_k the distance between the poles referred to the commutator and $T = \frac{1}{c}$, the duration of a period of the alternate current, the commutation lasts from

$$t = - \frac{\frac{1}{2} b_1 T}{\tau_k 2} = - \frac{b_1}{2 \tau_k} \frac{1}{2 c}$$

to

$$t = + \frac{\frac{1}{2} b_1 T}{\tau_k 2} = + \frac{b_1}{2 \tau_k} \frac{1}{2 c}$$

The alternate current i , therefore, changes its strength during the commutation from

$$i_1 = I \sqrt{2} \sin \left(\alpha - \Psi - \frac{b_1 \pi}{4 \tau_k} \right)$$

to

$$i_2 = I \sqrt{2} \sin \left(\alpha - \Psi + \frac{b_1 \pi}{4 \tau_k} \right)$$

whence follows:

$$i_2 - i_1 = 2 \sqrt{2} I \cos (\alpha - \Psi) \sin \frac{b_1 \pi}{4 \tau_k}$$

Since $\frac{b_1}{4 \tau_k}$ is a small quantity, one may assume $\frac{\sin \frac{b_1 \pi}{4 \tau_k}}{\frac{b_1 \pi}{4 \tau_k}} = \frac{b_1 \pi}{4 \tau_k}$

and obtain $i_2 - i_1 = \frac{\pi b_1}{4 \tau_k} \cdot I \sqrt{2} \cos (\alpha - \Psi)$

The total change of current during commutation is, therefore, equal to

$$I_g - (i_2 - i_1) = I_g - \frac{\pi b_1}{2 \tau_k} I \sqrt{2} \cos (\alpha - \Psi) = \frac{I_g}{k_b}$$

It is smallest when $a - \psi = 0$, and greatest when $a - \psi = \frac{\pi}{2}$. The last member ordinarily makes only 5 to 10 per cent of the first, because

$$b_1 \sim \frac{1}{10} \text{ to } \frac{1}{100} \tau_b \text{ and } I \sim \frac{1}{2} I_p.$$

The coefficient k_k lies, therefore, between 1.05 and 1.1.

If we term AS^1 the specific load of the armature as a direct-current machine, and AS the same as a converter, with the same strength of direct current, the slot field varies thus,

$$\frac{2 AS^1 \lambda_N}{k_k} = \frac{2 AS \lambda_N}{k_k \sqrt{\nu}}$$

where $\nu = \frac{AS}{AS^1}$ indicates the ratio between the efficiency of a direct-current machine to that of a converter of the same dimensions.⁸

Since in a single-phase converter the armature field is infinitely small, there is induced in the segments lying under the brush tips an e.m.f. at load which differs from that at no load approximately in the relation

$$2 \Delta e = \frac{b_1}{\beta} \frac{p}{a} \frac{N}{K} l_1 v \frac{2 AS}{k_k \sqrt{\nu}} \lambda_N \frac{t_1}{t_1 + b_r - \beta_r} 10^{-8} \text{ volts.}$$

If the brushes are displaced so far into the field that the e.m.f. between the brushes at half-load is equal to 0, the greatest e.m.f. which is induced between the brushes becomes equal to

$$\Delta e = \frac{b_1}{\beta} \frac{p}{a} \frac{N}{K} l_1 v \frac{2 AS}{k_k \sqrt{\nu}} \lambda_N \frac{t_1}{t_1 + b_r - \beta_r} 10^{-8} \text{ volts.}$$

This e.m.f. produces also here an additional current i_{s_2} for which the same equations hold as in direct-current machines.

When converters oscillate the brushes spark. This is easy to understand, for during oscillation energy passes back and forth between the converter and the circuit. The converter works now as a converter then as a generator, on account of which cross-fields are produced, which, just as in direct-current machines, cause a displacement of the potential curve at the commutator.

The strength of the cross-fields in the commutating zone we indicate in direct-current machines by B_a . The cross-field varies between $+B_a$ and $-B_a$. The cross-field B_a is dependent, first,

8. See "Die Wechselstromtechnik," Bd. IV. "Die Synchronen Wechselstrom Maschinen," by E. Arnold and J. L. la Cour, page 694.

on the specific magnetic conductivity λ_q of the cross-field in the commutating zone, and, secondly, on the variation of the electric energy. If we indicate the ratio between the variable part of the electric energy and the normal energy of the converter by k_p , then

$$B_q = 2 \lambda_q k_p \frac{AS}{\sqrt{v}}$$

The e.m.f., which in the most unfavorable case is induced between the brushes, equals

$$\Delta e^1 = \frac{b_1 p N}{\beta a K} l_1 v \frac{AS}{\sqrt{v}} \left(\frac{\lambda_N t_1}{k_x (t_1 + b_r - \beta_r)} + k_p \lambda_q \right) 10^{-8} \text{ volts.}$$

If this e.m.f. becomes too great the brushes spark. Hence, it is necessary, with reference to good commutation, to see that the electric energy does not vary too much. The specific magnetic conductivity λ_q of the cross-field may be calculated from the dimensions of the converter. If the pole arc is about two-thirds of the pole pitch; λ_q varies according to the saturation of the teeth between 2 and 4. The more completely the teeth and the pole tips are saturated, the smaller is the magnetic conductivity. If one assumes $\Delta e^1 \simeq 7.5$ volts and $\lambda_q \simeq 3$, the greatest value, which k_p may have before the commutation is disturbed, results directly from the above formula.

14. THE CASCADE CONVERTER.⁹

In a series converter whose asynchronous machine possesses p_a pole-pairs and whose direct-current machine possesses p_o pole-pairs $\frac{p_o}{p_a + p_o} KW$ in the direct-current machine is transformed from alternating current to direct current and $\frac{p_a}{p_a + p_o}$ directly generated. Consequently, the e.m.f. is

$$\Delta e = \frac{b_1 p N}{\beta a K} l_1 v \frac{AS}{k_x \sqrt{v}} \left(\lambda_N \frac{t_1}{t_1 + b_r - \beta_r} + \frac{p_a}{p_a + p_o} \lambda_q \right) 10^{-8} \text{ volts.}$$

The commutating ratios prove themselves more favorable in the series converter than in the ordinary converter, because at equal frequencies the direct-current machine of the cascade converter obtains fewer poles and therefore a much larger pole distribution on the commutator at the same surface velocity. The difference

⁹ See also E. Arnold and J. L. la Cour, "Der Kaskadenumformer Seine Theorie, Berechnung, Konstruktion und Arbeitsweise."

of voltage between two neighboring segments of the commutator can, for this reason, be kept considerably smaller in the cascade converter than in the ordinary converters, which is of great importance in commutation.

COMMUTATION OF ALTERNATING CURRENTS.

15. POLYPHASE COMMUTATOR MACHINES.

Let us consider a three-phase commutator machine, Fig. 45, with a direct-current winding on the armature. If one supplies to the stator winding a three-phase current, there is produced a rotary field, which pulsates weakly. This rotary field is best analyzed into a sine-shaped fundamental field and into harmonic

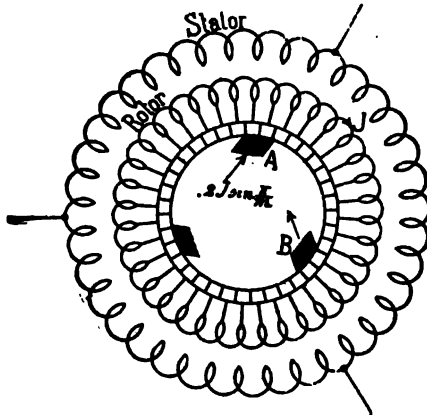

FIG. 45. STATOR AND ROTOR WINDING OF A THREE-PHASE COMMUTATOR MOTOR.

fields. The first rotates with synchronous speed $n_D = \frac{60c}{p}$ revs. per minute; c is the frequency and p the number of pairs of poles in the machine. Since the harmonic fields are ordinarily very small, these may be neglected in what follows. If we let the armature be driven by a current from an external source and rotate in this field with n revolutions per minute, there is induced in every winding of the armature, composed of $\frac{N}{K}$ wires, an e.m.f. proportional to $(n_D - n)$ and of the frequency

$$c_s = \frac{p(n_D - n)}{60} = c - c_r; \quad c_s = \omega$$

is the frequency of the slip and $c_r = \frac{p}{60} n$ the frequency of the rotation of the armature. If the flux per pole is Φ , there is induced in every armature coil an effective e.m.f.

$$e_r = 2.22 c_r \frac{N}{K} \Phi 10^{-8} \text{ volts.}$$

If we add the e.m.fs. induced in all the armature coils, and plot the sum as a function of commutator periphery, we obtain the potential curve of the commutator. This, with lifted commutator brushes, is almost a sine curve, Fig. 46, which rotates with the speed n_D r.p.m. in space.

If carbon brushes are applied at three places, the potential curve under the brushes is deformed at every moment in the same way as in direct-current machines. The additional current in the armature coils, and the deformation of the potential curve produced thereby, depends naturally on the local gradient of the potential curve under the brushes (with lifted brushes).

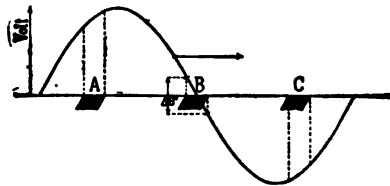

FIG. 46. POTENTIAL CURVE OF THREE-PHASE COMMUTATOR MOTOR.

On the assumption that no current is brought to the armature winding through the brushes, we obtain the maximum e.m.f. Δe_1 between the segments lying under the brush tips

$$\Delta e^1 = \sqrt{2} e_r \frac{b_1 p}{\beta a} = \frac{b_1 p}{\beta a} \pi c_r \frac{N}{K} \Phi 10^{-8} \text{ volts,}$$

$$\text{or } \Delta e^1 = \frac{b_1 p}{\beta a} \frac{N}{K} l_1 v_D s B_1 10^{-8} \text{ volts.}$$

Where B_1 indicates the maximum induction in the air-space and $s = \frac{n_D - n}{n_D}$ the slip. v_D is the peripheral velocity of the rotary field.

If, in addition, a current is brought to the armature winding through the commutator brushes, there is produced an increase of potential difference between brush and commutator, just as in

direct-current machines, as well as a displacement of the potential curve of the commutator.

At the moment when the vertex of the potential curve is under the middle point of a brush, the brush supplies a current equal to the amplitude of the watt current I_w and at the moment when the potential curve in the middle point of a brush passes through zero, the brush gives a current equal to the amplitude of the wattless current I_{wt} .

At the first moment considered, when the amplitude of the potential curve is under the middle point of the brush, no e.m.f. is induced by the main field of the machine between the brush tips, but only an e.m.f. produced by the slot field of the watt current. If the specific load of the armature is AS , and m the number of the rotor phases, the slot field at this moment is altered by

$$2 \sin \frac{\pi}{m} AS \sqrt{2} \cos \varphi \lambda_N$$

and an e.m.f. is induced between the brush points equal to

$$\Delta e_w = \frac{b_1 p N}{\beta a K} l_t v 2 \sqrt{2} \sin \frac{\pi}{m} AS \cos \varphi \lambda_N \frac{t_1}{t_1 + b_r - \beta_r} 10^{-8} \text{ volts.}$$

$\cos \varphi$ is the power factor of the armature current.

At the second moment, when the potential curve at the middle point of a brush passes through zero, the e.m.f. induced by the main field is $\Delta e'$ and that induced by the slot field.

$$\Delta e'' = \frac{b_1 p N}{\beta a K} l_t v 2 \sqrt{2} \sin \frac{\pi}{m} AS \sin \varphi \lambda_N \frac{t_1}{t_1 + b_r - \beta_r} 10^{-8} \text{ volts.}$$

The sum of $\Delta e'$ and $\Delta e''$ gives us the e.m.f. induced between the brush tips at this moment.

$$\Delta e_{wt} = \frac{b_1 p N}{\beta a K} l_t \left(v_D s B_t + 2 \sqrt{2} \sin \frac{\pi}{m} AS \sin \varphi v \lambda_N \frac{t_1}{t_1 + b_r - \beta_r} \right) 10^{-8}$$

We can now, in the same way as in direct-current machines, calculate the maximum additional current i_{max} for these two moments, and, hence, deduce the conditions for good commutation in polyphase machines.

In Figs. 47 to 50, oscillograms are presented which were recorded with the experimental apparatus represented in Fig. 30. Only the source of current here is not a storage battery, but a transformer for very large currents. Its voltage, therefore, was scarcely influ-



FIG. 48A.

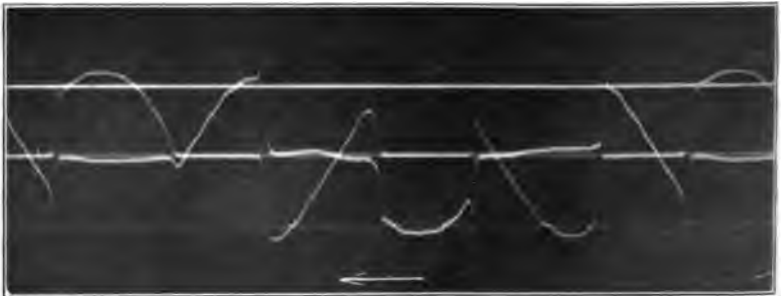

FIG. 49A.

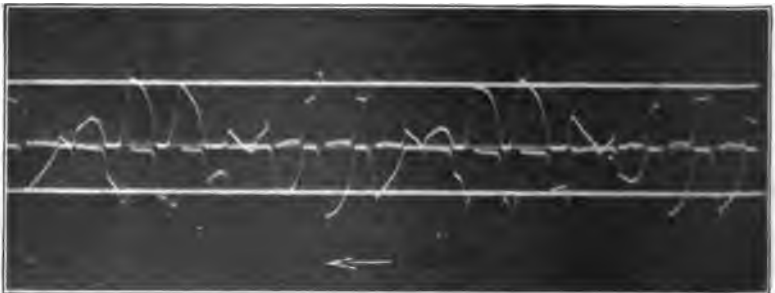
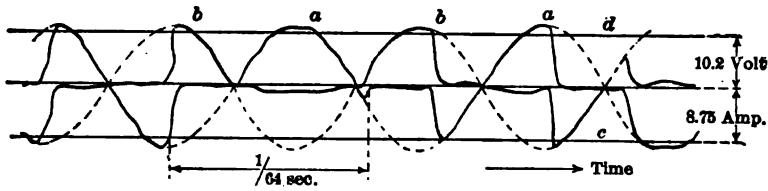
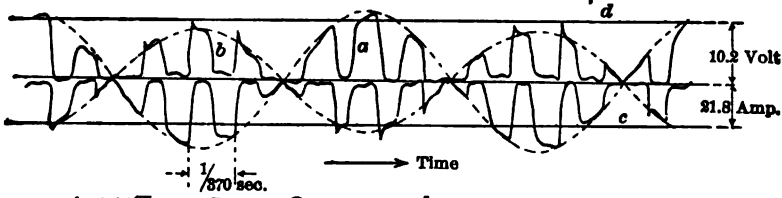

FIG. 50A.



$\Delta e = 4.8\sqrt{2}$ V. $R_1 = 0.73 \Omega$ $S \approx 2.5 \cdot 10^{-5}$ Henry $n = 255$. $v_k = 2.97$ m/sec.

FIG. 47. NO SPARKS WHATEVER.



$\Delta e = 5.2\sqrt{2}$ V. $R_1 = 0.815 \Omega$ $S \approx 2.5 \cdot 10^{-5}$ Henry $n = 1475$. $v_k = 15.5$ m/sec.

FIG. 48. VERY SLIGHT SPARKING.

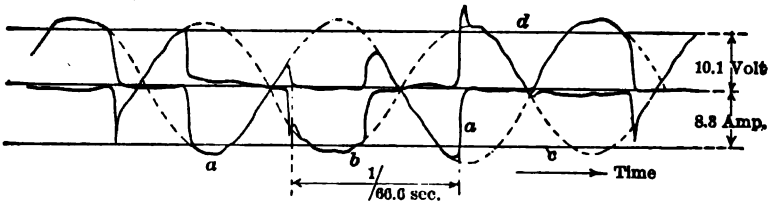

$\Delta e = 5.2\sqrt{2}$ V. $R_1 = 0.815 \Omega$ $S \approx 18.5 \cdot 10^{-5}$ Henry $n = 270$. $v_k = 2.99$ m/sec.

FIG. 49. SLIGHT SPARKING.

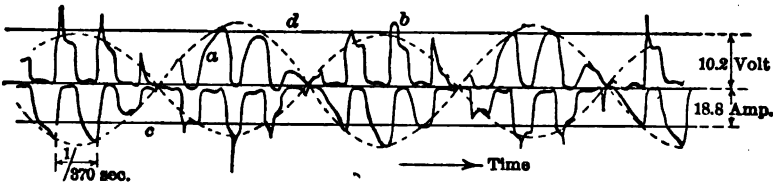

$\Delta e = 6\sqrt{2}$ V. $R_1 = 0.835 \Omega$ $S \approx 18.5 \cdot 10^{-5}$ Henry $n = 1475$. $v_k = 15.5$ m/sec.

FIG. 50. VERY STRONG SPARKING.

enced by the current flowing over the commutator during the commutating process. In the oscillograms the curves of current and voltage, marked respectively a and b , are for the sake of clearness, plotted on opposite sides. Moreover, the sine curves are dotted, according to which current and voltage would have varied approximately if the current had not been broken from time to time.

As may be seen from the oscillograms, the additional current is chiefly dependent on the e.m.f. present at the moment, and in the second place, at the breaking of the current, the same phenomena appear in the voltage curve as upon application of a constant voltage. Hence, follows that all the conditions deduced for good commutation in direct-current machines may be applied directly to the alternating-current machine.

We have thus first to determine the maximum e.m.f. Δe between the brush tips; this is equal to

$$\Delta e = \sqrt{\Delta e_w^2 + \Delta e_{tot}^2}$$

In order that this may remain small in direct-current machines

$\frac{b_1}{\beta}$, $\frac{p}{a}$, $\frac{N}{K}$, l , and v should be kept as small as possible. Further, B_i and $AS\lambda_N$ should be small.

For this reason, polyphase commutator motors work well only near the synchronous speed when the slip s is small. Much above synchronism, it is not possible to make polyphase commutator motors run sparklessly.

In this case sB_i is not only large, but also v , so that the spark energy F or F_m may become very great.

In polyphase commutator motors, therefore, with adjustable speed, each brush should cover as few laminations as possible in order that $\frac{b_1}{\beta}$ may remain small. Further, $\frac{p}{a}$ should be small.

$\frac{N}{K}$ can not be made smaller than 2 with the application of only one commutator. By using two commutators $\frac{N}{K}$ can be forced down to 1; this arrangement, however, brings about difficulties of construction and increases considerably the cost of the machine. Since also B_i and AS should be small, it is evident that the commutator motors on account of the commutation can not be made of such small dimensions as was first believed from a consideration of their power factor.

If one makes the rotor six-phase instead of three, the current

per holder becomes less, and, consequently, the change of current in the slots appearing in every brush. This is expressed in the formula by the factor $2 \sin \frac{\pi}{m}$. This is the ratio between the current taken through a brush and the current flowing in the armature wires. Moreover, the width of the brushes b_1 can be made smaller with six brushes per pair of poles.

If Δe is calculated, $i_{s, \max}$ can be reckoned according to the formula page 842. Since in alternating-current motors large values of Δe arise, a great resistance R_v is often given to the connecting wires between the armature winding and the commutator, and generally very hard carbon brushes are used. Of course, these resistances cause considerable losses, which keep down the efficiency of the motor as well as heat it considerably. Hence, a limit is soon reached to the value of R_v .

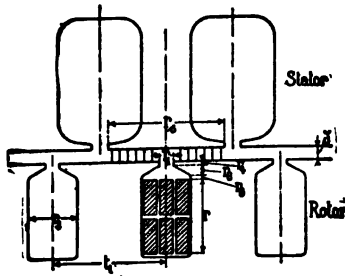

FIG. 51. MOTOR WITH UNIFORMLY DISTRIBUTED STATOR IRON.

Concerning the spark energy F_m or F , this varies in alternating-current motors between a maximum and zero. Hence, one can admit for the energy resulting from $i_{s, \max}$ a greater value in alternating-current machines than in direct-current machines.

16. THE COEFFICIENT OF STRAY FIELD OF POLYPHASE COMMUTATOR MOTORS.

The value to be introduced in the formula for Δe_w and Δe_{wt} for the conductivity λ_N of the slots results in the same way as in the ordinary asynchronous motors.

For the rotor the conductivity, Fig. 51, becomes

$$\lambda_{N_r} = 1.95 \left\{ \frac{r}{3 r_s} + \frac{r_s}{r_s} + \frac{2 r_s}{r_1 + r_s} + \frac{r_1}{r_1} + \frac{r_s - r_1}{8 \delta} \right\} + 0.5 \frac{l}{l_1}$$

In the same way we find the conductivity λ_{Ns} of the stator if we substitute in the above formula the analogous measurements of the stator. It now becomes $\lambda_N = \lambda_{Nr} + \lambda_{Ns}$. If the slots of the stator and rotor are approximately equal, one may write $\lambda_N = 2 \lambda_{Nr}$.

In order that λ_N may remain as small as possible, the slots of the rotor should be wide and open and the number of slots in both rotor and stator should be rather large.

In the formulas for the coefficient of stray field S of a short-circuited coil, the same conductivity λ_N is to be introduced. This may be experimentally proved in the following way: Measure the reactance between two neighboring segments of the commutator, once with open and once with short-circuited stator winding. If the stator winding is connected with an alternating-current circuit, it behaves with respect to the separate coils of the rotor winding as if short-circuited. The following measurements were made on an alternating-current commutator motor which possesses direct-current windings on both stator and rotor:

The motor has 6 poles and has a series winding with 3 turns per commutator. So there lie $\frac{p}{a} \frac{N}{K} = 3 \times 6 = 18$ wires between two adjoining segments of the commutator. Of these 18 successive wires resulted with a 50-cycle alternating current in

$x \approx 0.060$ ohm with open stator, and in

$x \approx 0.025$ ohm with single-phase short-circuited stator winding, when the short-circuited stator coil lies in the neutral zone of the stator field;

$x \approx 0.021$ in a three-phase short-circuited stator winding;

$x \approx 0.017$ in a four-phase short-circuited stator winding, and

$x \approx 0.016$ if all armature coils were short-circuited.

As is evident from the above, the stator winding works with a strong damping effect on the flux generated by an extraneous current, and in the formula for S the above value of λ_N is to be introduced.

For the magnetic conductivity of an alternating-current motor, the sum of the reactances of the entire stator and rotor winding should be taken. Hence, in commutator motors it is of interest to investigate whether the rotor reactance increases, as in ordinary asynchronous motors, proportionally to the slip. If we consider Fig. 45, it appears that in the part of the armature winding which

lies between the brushes, a current of the full frequency c always flows, however large the speed of rotation of the rotor may be. Hence, one ought to expect that the reactance of the rotor winding is independent of the speed of rotation, just as at rest. This, however, is not the case; on the other hand, the assumption made by different authors that the rotor reactance increases proportionally to the slip is also not quite correct. The rotor reactance shows a behavior that lies between these two assumptions.

The part of the rotor winding which lies under the brushes has a reactance independent of the slip. The voltage corresponding to this reactance displaces the potential curve of the commutator. In the part of the rotor winding which lies under the brushes a considerable e.m.f. is also induced, and this displaces the potential curve in the opposite direction, as Fig. 52 shows in the case of

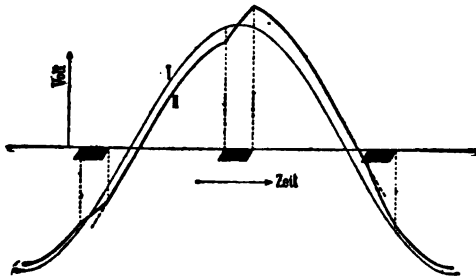

FIG. 52. DISTORTION OF POTENTIAL CURVE AT COMMUTATOR, DUE TO THE E.M.F.'S. INDUCED IN THE SHORT-CIRCUITED COILS.

a three-phase rotor. The voltage of reactance, which is generated by the commutation, must, therefore, be subtracted from the voltage of reactance of the rotor windings lying between the brushes.

If we indicate the effective current in the armature conductors by I , and the reactance of winding between two brushes by x ,

$$Ix_s = I 2 \pi c \frac{Z}{m} \left(\frac{N}{Z} \right)^2 l_4 \lambda_N 10^{-8} \text{ volts,}$$

where N signifies the number of wires in series, and Z the number of rotor slots. Hence, $Ix_s = 2 \pi c \frac{IN}{m} \frac{N}{Z} l_4 \lambda_N 10^{-8}$ volts.

If we assume $IN = \pi D AS$

$$c = \frac{n_D}{60} \text{ (for a two-pole machine)}$$

$$\text{and } \frac{\pi D n_D}{60} = 100 v_D$$

$$\text{then } Ix_s = \frac{2\pi}{m} \frac{N}{Z} AS l_4 v_D \lambda_N 10^{-8} \text{ volt.}$$

If we consider now the parts of the armature winding lying under half of the two brushes *A* and *B*, Fig. 45, there is induced, by the commutation of the current *I* in these coils, an effective e.m.f.

$$\frac{\Delta e}{\sqrt{2}} = \frac{b_1}{\beta} \frac{N}{K} l_4 v \frac{2\pi}{m} AS \lambda_N \frac{t_1}{t_1 + b_r - \beta_r} 10^{-8} \text{ volts.}$$

This e.m.f. generates an additional current i_s in the short-circuited coils, so that only a displacement of the potential curve takes place about $\frac{\Delta p}{\sqrt{2}}$. An e.m.f. is induced not only in the short-

circuited coils themselves, but also in the coils of the same slots that are not short-circuited. This e.m.f. can be approximately

represented by writing the factor $\frac{b}{\beta} \frac{N}{K} \frac{t_1}{t_1 + b_r - \beta_r} = \frac{N}{Z}$

The whole displacement of the potential curve, caused by the commutation of the current *I*, becomes, therefore, approximately equal to

$$Ix_r = \frac{\Delta p}{\Delta e} \frac{N 2\pi}{Z m} AS l_4 v \lambda_N 10^{-8} \text{ volts,}$$

$$\text{or } Ix_r = \frac{\Delta p}{\Delta e} \frac{v}{v_D} Ix_s = \frac{\Delta p}{\Delta e} \frac{n}{n_D} Ix_s = \frac{\Delta p}{\Delta e} (1-s) Ix_s$$

and we obtain as the resulting reactance of the rotor winding per phase

$$x_r = x_s - x_r = x_s \left\{ 1 - \frac{\Delta p}{\Delta e} \frac{n}{n_D} \right\} = x_s \left\{ 1 - \frac{\Delta p}{\Delta e} (1-s) \right\}$$

The factor $\frac{\Delta p}{\Delta e}$ can be reckoned in the way given on page 821.

Thus, the reactance of the rotor increases with the slip, but not proportional to it as some authors assume, but more slowly, since

in alternating-current motors the factor $\frac{\Delta p}{\Delta e}$ is rather small. In

Fig. 53 the short-circuit reactances obtained experimentally from a three-phase and four-phase commutator motor are plotted as functions of the speed of rotation. As may be seen in these

curves, the short-circuit reactance, that is, the sum of the stator and rotor reactances, falls with the speed, as it ought, according to the above calculation.

In making these measurements, the current was supplied to the commutator brushes, while the stator winding was short-circuited. Thus the rotary field, which is, of course, very small at synchronism relative to the rotor, stands at rest and induces no e.m.f. in the rotor winding. On the contrary, the rotary field induces in

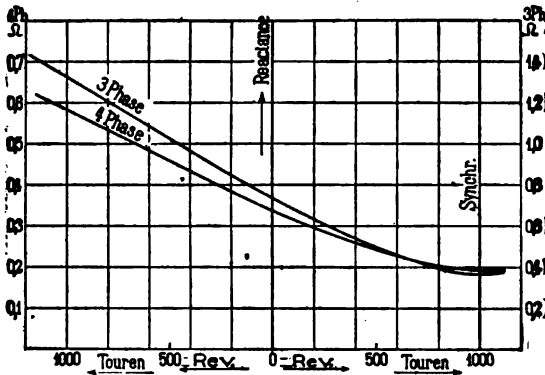

FIG. 53. REACTANCE AS FUNCTION OF REVOLUTIONS.

the stator winding the e.m.f. which is necessary for the generation of the stator current. At synchronism (1000 r.p.m.) the reactance of the stator disappears while reactance of the rotor disappears only in part. The reactance remaining at synchronism is, therefore, a true rotor reactance and equal to

$$X_s \left(1 - \frac{\Delta p}{\Delta \epsilon} \right)$$

17. SINGLE-PHASE COMMUTATOR MOTOR WITH ALTERNATING FIELD.

To this class belong pure series-motors and shunt-motors for alternating current. In these motors the main field is an alternating field in whose neutral zone the commutator brushes stand. If on the pole-shoes of a direct-current machine compensating coils are applied, through which the armature current flows, the armature reaction can be completely annulled, and in the formula for $\Delta \epsilon$ we must substitute the conductivity $\lambda_q = 0$.

If we go further and laminate the entire field system, we obtain

a motor which is suitable for both alternating and direct currents. In each coil short-circuited through the commutator brushes a maximum e.m.f. is induced at the moment when the main field Φ passes through zero—

$$e_p = \frac{N}{K} \pi c \Phi 10^{-8} \text{ volts}$$

and at the moment when the armature current reaches its maximum is induced a maximum e.m.f.—

$$e_r = \frac{N}{K}^2 \sqrt{2} AS l_v \lambda_N \frac{t_1}{t_1 + b_r - \beta_r} 10^{-8} \text{ volts.}$$

In series-motors these two moments differ from each other about 90 deg. in phase, so that the maximum e.m.f. which is induced in the segments lying under the brush tips is equal to

$$\Delta e = \frac{b_1}{\beta} \frac{p}{\alpha} \sqrt{e_p^2 + e_r^2}$$

We can now calculate in the ordinary way the maximum additional current $i_{s \max}$ and the mean spark energy F_m or F . Of the two components, e_p and e_r , the first, e_p , is generally by far the greater. In order to keep this small, the frequency c and the flux Φ per pole must be kept as small as possible. Therefore, the construction of series-motors for frequencies greater than 25 causes serious difficulties. In order that $i_{s \max}$ may not become too great, it is necessary in all series-motors to use very hard carbon brushes and insert large resistances in the connecting wires between the winding of the armature and the commutator.

In single-phase motors the rotor reactance does not decrease with the frequency, because the e.m.f. induced in the short-circuited coils by the commutation of the current is in phase with the current and not in quadrature, as in polyphase motors.

In Fig. 54, the short-circuited reactance obtained experimentally on a single-phase motor with laminated fields is plotted as a function of the speed of rotation. The curve A refers to the case when the current is carried to the rotor winding R , while the compensation winding K is short-circuited.

As may be seen, the short-circuit reactance decreases with the speed of rotation; this, however, arises from the fact that the stator reactance disappears at synchronism. If, on the other hand, the current is carried to the compensating winding, and the rotor winding is short-circuited, one obtains the nearly horizontal line B .

Single-phase motors which work with alternating current may be built with solid poles as well as with laminated magnetic circuits. The motors with solid poles are simpler in construction and more favorable in respect to commutation, because the coefficient of stray induction S of the short-circuited coils is smaller. This happens because no field iron but large pole gaps stand opposite the short-circuited coils.

In single-phase motors the commutation plays the main part; so that the series-motors with solid poles are to be preferred for the above reasons to the motors with laminated magnetic circuits.

18. REPULSION MOTORS.

Whether repulsion motors are compensated or not for phase difference plays no great part in their phenomena of commutation. The common characteristic of all these motors consists in the fact

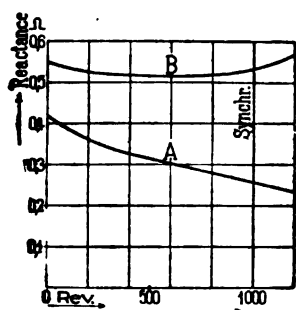

FIG. 54. REACTANCE AS FUNCTION OF REVOLUTIONS.

that at rest they behave exactly like single-phase series motors, and near synchronism like polyphase commutator motors. They operate near synchronism with a rotary field, and must, therefore, be constructed with laminated iron in their stators. Otherwise very great iron losses would occur in the armature iron.

Concerning the commutation, at rest the same e.m.f.

$$\Delta e_s = \frac{b_1 p N}{\beta a K} \pi c \Phi 10^{-8} \text{ volts}$$

is induced in the segments lying under the brush tips, as in series motors.

At synchronism, on the contrary, no e.m.f. is induced by the

main field, but only by the slot field under the brush tips. This maximum e.m.f. is

$$\Delta e_0 = \frac{b_1 p}{\beta a} \frac{N}{K} 2 \sqrt{2} AS l_t v \lambda_N \frac{t_1}{t_1 + b_r - \beta_r} 10^{-8} \text{ volts.}$$

In the ordinary repulsion motors, at a given speed of rotation n , there is induced in every short-circuited armature coil by the main field a maximum e.m.f.—

$$e_p = \frac{N}{K} \pi c \Phi \left(1 - \left(\frac{n}{n_D}\right)^2\right) 10^{-8} \text{ volts}$$

and by the slot field a maximum e.m.f.—

$$e_r = \frac{N}{K} 2 \sqrt{2} AS l_t v \lambda_N \frac{t_1}{t_1 + b_r - \beta_r} 10^{-8} \text{ volts}$$

when the motor possesses only one pair of short-circuited brushes per pair of poles and

$$e_r = \frac{N}{K} \sqrt{2} AS l_t v \lambda_N \frac{t_1}{t_1 + b_r - \beta_r} 10^{-8} \text{ volts}$$

when the motor has two pairs of short-circuited brushes per pair of poles. In these formulas for e_p and e_r , AS indicates the specific load of the armature coming from the short-circuit current.

e_p and e_r differ in phase from each other approximately by 90 deg., so that the maximum e.m.f. between the brush points is equal to that of the pure repulsion motor—

$$\Delta e = \frac{p}{a} \frac{b_1}{\beta} \sqrt{e_p^2 + e_r^2}$$

In the compensated motor, Fig. 55, one obtains for the short-circuited pair of brushes $B_1 B_2$ the same e.m.f. Δe as for the ordinary repulsion motion, when AS has the same signification as in that case and

$$e_r = \frac{N}{K} 2 \sqrt{2} AS l_t v \lambda_N \frac{t_1}{t_1 + b_r - \beta_r} 10^{-8} \text{ volts.}$$

For the pair of brushes $B_2 B_4$ leading in the magnetizing current $e_p = 0$ and

$$e_r^1 = \frac{N}{K} 2 \sqrt{2} AS^1 l_t v \lambda_N \frac{t_1}{t_1 + b_r - \beta_r} 10^{-8} \text{ volts.}$$

where AS^1 indicates the specific load of the armature from the magnetizing current.

Hence, for the pair of brushes B_2, B_4 ,

$$\Delta e = \frac{2}{a} \frac{b_1 N}{\beta K} \sqrt{2} AS^1 l v \lambda_N \frac{t_1}{t_1 + b_r - \beta} 10^{-8} \text{ volts.}$$

Thus, it is evident that the compensated motor is no more favorable in the matter of commutation than the repulsion motor with one pair of short-circuited brushes per pair of poles. Since the mean spark energy is proportional to the surface velocity v of the commutator, $i_{s \text{ max}}$ may have a much greater value at the start than at a greater speed. The repulsion motors and compensated motors work, therefore, at the start as satisfactorily as at greater velocities, though the coefficient of stray induction S of the short-circuited coils is greater than in the true series motor.

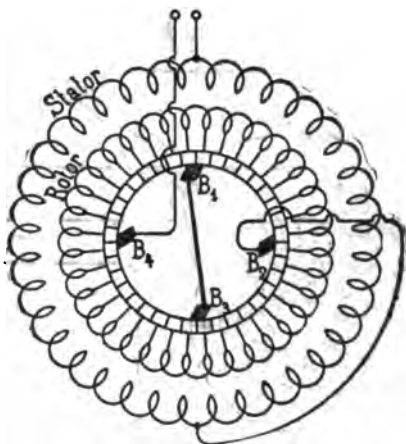

FIG. 55. STATOR AND ROTOR WINDING OF COMPENSATED SINGLE-PHASE MOTOR.

To discuss more exactly the dimensions of the alternating-current commutator motor, although this should be done mainly in reference to the commutation, would lead us too far. Hence, only a few of the later commutators will be mentioned in the following:

19. COMMUTATOR FOR THE TRANSFORMATION OF A POLYPHASE CURRENT INTO A DIRECT CURRENT OR INTO A POLYPHASE CURRENT OF LOWER FREQUENCY, ACCORDING TO THE HEYLAND METHOD.

a). *Commutator for synchronous machines.*

In order to make a polyphase machine self-exciting, or to compound it, the polyphase current must be converted into direct

current. This may be effected by means of a commutator. Such a commutator as was proposed in 1903 by A. Heyland is represented in Fig. 56. The magnetic winding *GF* of the generator is divided into four parts, which are wound parallel on the same magnet core, Fig. 56a, in order to obtain a large mutual induction of the separate branches. The separate parts, as the figure shows, are electrically connected with each other at several points. These connections serve to balance the currents and the voltages which are produced in the commutation of the current.

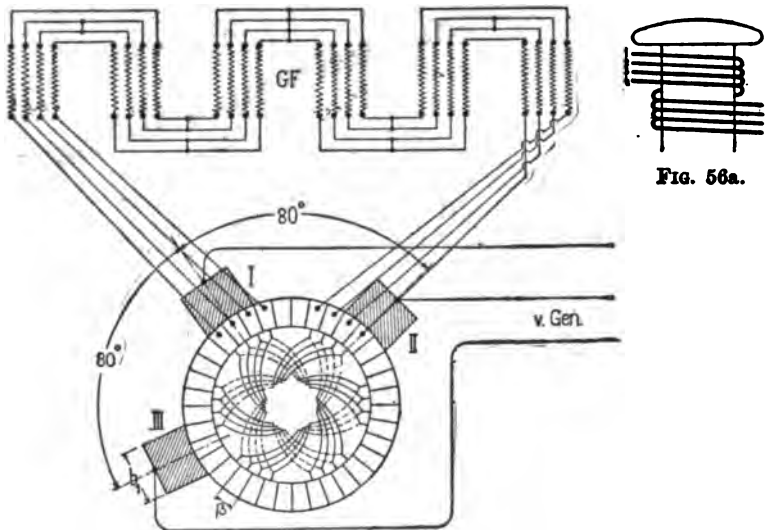

FIG. 56. CONNECTIONS OF HEYLAND COMMUTATOR FOR SELF-EXCITATION OF A SIX-POLE SYNCHRONOUS MACHINE.

The commutator has six segments per pole, of which four are connected with the four branches of the field winding, while the other two laminations remain without connection and serve only as insulation between the current-bearing laminations of two neighboring poles. The current-bearing laminations which lie at a distance from each other of twice the pole pitch in the commutator, receive always the same potential and, therefore, need not be connected by inner cross-connections in the commutator. In this way it is possible to get along with one brush per phase and to set the brushes on any pair of poles at will. Thus, a better distribution of the brushes on the surface of the armature is effected so that they can be more easily applied. In the

commutator, Fig. 56, the brushes *I* and *III* lie under the same pair of poles, while brush *II* is set under the following pair. Thus results a difference of set of brushes of 240 electrical deg. or 80 deg. in space.

If the commutator rotates in synchronism with the polyphase generator, there results, as will be shown, a potential curve of which the first harmonic is at rest relatively to the commutator. This, which at the same time is the mean potential curve of the commutator, causes a current of constant direction and strength, that is, a direct current to flow through the field winding.

b). The mean potential curve of the commutator.

Let us provisionally assume only one brush to be set on the commutator whose potential alternates sinusoidally. If *P* is the effective value of the potential, the brush potential becomes

$$p_b = \sqrt{2} P \sin \omega t$$

If we think first of the commutator at rest, the potential curve of Fig. 57 results. This potential curve may be decomposed into

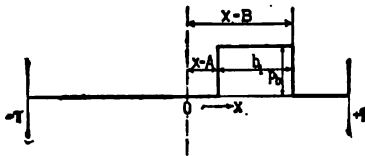

FIG. 57.

its harmonics and we obtain for the potential at a given point *X* of the surface of the commutator, the equation—

$$p_s = \frac{2}{\pi} p_b \sum_1^n \frac{1}{n} \cos n \left(\frac{B+A}{2} - x \right) \sin n \left(\frac{B-A}{2} \right)$$

Let us now assume that the commutator is fixed, but allow the brushes to rotate in synchronism. We obtain exactly the same result as in the ordinary conditions of operation when with fixed brushes the commutator rotates. The fixed coordinates *A* and *B* pass over into the variables *a* and *b* and we must write

$$a = A + \omega t, \quad b = B + \omega t.$$

With this we find

$$p_s = \frac{2}{\pi} \sqrt{2} P \sin \omega t \sum_1^n \frac{1}{n} \cos n \left(\frac{B+A}{2} - x + \omega t \right) \sin n \left(\frac{B-A}{2} \right)$$

$$= \frac{\sqrt{2}}{\pi} P \sum_1^n \frac{1}{n} \sin n \frac{B-A}{2} \left\{ \sin \left[n \left(\frac{B+A}{2} - \alpha \right) + (n+1) \omega t \right] \right. \\ \left. - \sin \left[n \left(\frac{B+A}{2} - \alpha \right) + (n-1) \omega t \right] \right\}$$

And for the first harmonic ($n=1$)

$$P_{\omega} = \frac{\sqrt{2}}{\pi} P \sin \frac{B-A}{2} \left\{ \sin \left(\frac{B+A}{2} - \alpha + 2 \omega t \right) - \sin \left(\frac{B+A}{2} - \alpha \right) \right\}$$

If we apply now to the commutator two additional brushes of equal width b_1 , at a distance of 120 deg. or 240 deg. from the first, there result from these as coordinates:

$$a_n = A - 120^\circ + \omega t$$

$$b_n = B - 120^\circ + \omega t$$

$$a_m = A - 240^\circ + \omega t$$

$$b_m = B - 240^\circ + \omega t$$

If we connect the brushes to a three-phase generator, we obtain for the potentials:

$$p_{b_1} = \sqrt{2} P \sin (\omega t)$$

$$p_{b_n} = \sqrt{2} P \sin (\omega t - 120^\circ)$$

$$p_{b_m} = \sqrt{2} P \sin (\omega t - 240^\circ)$$

Whence results that in order to obtain the potential curves of the other two brushes we only have to substitute in the above equations in the place of ωt the values $\omega t - 120^\circ$ or $\omega t - 240^\circ$. If we add the first harmonics of the potential curve of the three brushes, we obtain as the resulting curve—

$$p_1 = \frac{\sqrt{2}}{\pi} P \sin \frac{B-A}{2} \left\{ \sin \left(\frac{B+A}{2} - \alpha + 2 \omega t \right) + \right. \\ \left. \sin \left(\frac{B+A}{2} - \alpha + 2 \omega t - 240^\circ \right) + \sin \left(\frac{B+A}{2} - \alpha + 2 \omega t - 480^\circ \right) \right. \\ \left. - 3 \sin \left(\frac{B+A}{2} - \alpha \right) \right\}$$

$$p_1 = -3 \frac{\sqrt{2}}{\pi} P \sin \frac{B-A}{2} \sin \left(\frac{B+A}{2} - \alpha \right)$$

We now transfer the zero point so that $A = -B$, and we substitute for $B-A$ the width of the brush $\frac{b_1}{\tau_b} \pi$, then results finally—

$$p_1 = 3 \frac{\sqrt{2}}{\pi} P \sin \frac{b_1}{\tau_b} \frac{\pi}{2} \sin \alpha$$

In this equation the time t no longer appears; the potential is dependent only on the situation of the point x . Hence follows that the first harmonic of the potential curve relatively to the commutator is at rest.

For any number of phases m , one obtains similarly—

$$p_1 = m \frac{\sqrt{2}}{\pi} P \sin \frac{b_1}{\tau_b} \frac{\pi}{2} \sin \alpha$$

The curve of the mean potential on the commutator is, therefore, a sine curve of the amplitude

$$P_{max} = m \frac{\sqrt{2}}{\pi} P \sin \frac{b_1}{\tau_b} \frac{\pi}{2}$$

where P indicates the phase voltage of the polyphase current carried to the brushes. The situation of the potential curve on the commutator may be determined, because the potential curve in the middle point of a brush passes through zero when the brush has the potential zero.

c). Influence of the width of the segments on the amplitude of the potential curve.

Hitherto the influence of the number and the width of the segments has been completely disregarded. The assumption previously made that the segment of the commutator's surface, which has approximately the same potential as the brushes, is equal to the width of the brushes, holds, however, only for an infinite number of laminations. In a finite number of laminations, this segment of the surface is about the width of one lamination β greater than the width of the brush b_1 ; consequently, we must substitute in the formula for P_{max} , $b_1 + \beta$ instead of b_1 . It becomes

$$P_{max} = m \frac{\sqrt{2}}{\pi} P \sin \frac{b_1 + \beta}{\tau_b} \frac{\pi}{2}$$

In order to avoid short circuit between the brushes, one must always make the brushes at least one lamination's width smaller

than the m th part of the double pole distribution $\frac{2 \tau_b}{m}$

$$b_1 \leq \frac{2 \tau_b}{m} - \beta$$

Hence,

$$\frac{b_1 + \beta}{\tau_p} \approx \frac{2}{m}$$

If we substitute this value in the equation for P_{max} , we obtain for the amplitude of the mean potential curve

$$P_{max} \approx \sqrt{2} \frac{m}{\pi} \sin \frac{\pi}{m} P$$

that is, for $m = 3$ $P_{max} \approx 1.15 P$.

" $m = 4$ $P_{max} \approx 1.27 P$.

" $m = 6$ $P_{max} \approx 1.35 P$.

d). *The currents generated by the mean potential curve.*

The situation of the sine curve relative to the connected segments depends on the position of the brushes. If the vertex of the potential curve is displaced towards the middle of the segments by the angle α , Fig. 58, one may decompose the sine curve

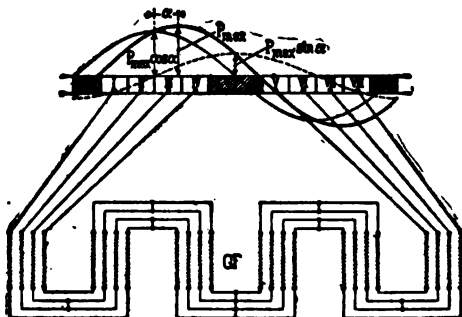

FIG. 58. MEAN POTENTIAL CURVE OF HEYLAND COMMUTATOR.

into two others, of which one has the amplitude $P_{max} \cos \alpha$ and the other the amplitude $P_{max} \sin \alpha$. The vertex of the first coincides with the middle point of the laminations, while the vertex of the second curve in the middle point of the laminations passes through zero.

The sine curve with the amplitude $P_{max} \cos \alpha$ furnishes the exciter current of the generator. In order to calculate exactly its m.m.f., one must first obtain the course of the currents in all

parts of the winding, Fig. 59, which is effected in the same way as are calculated the currents in a system of mains. For the sake of simplicity, let us suppose that the four parallel branches are not electrically connected with each other, then it is sufficient to calculate a mean potential for the connected laminations. If we have, for example, Fig. 59, four current-bearing

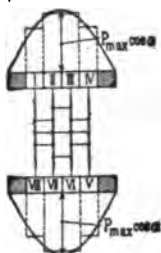

FIG. 59. DETERMINING THE MEAN EXCITATION VOLTAGE FOR A HEYLAND COMMUTATOR FOR SYNCHRONOUS MACHINES.

and two blind laminations per pole, the laminations *II*, *III*, *VI* and *VII* receive the mean potential—

$$P_{max} \cos \frac{180^\circ}{12} = 0.966 P_{max} \cos \alpha$$

and the remaining laminations the mean potential—

$$P_{max} \cos \alpha \cos 3 \frac{180^\circ}{12} = 0.707 P_{max} \cos \alpha.$$

The mean potential thus becomes—

$$\begin{aligned} P_{mean} &= P_{max} \cos \alpha \frac{0.966 + 0.707}{2} = 0.837 P_{max} \cos \alpha \\ &= f_p P_{max} \cos \alpha \end{aligned}$$

In like manner can be obtained the mean potential for every other number of laminations. For three connected laminations and two blind laminations, one finds, for example, $f_p = 0.870$ and for five connected laminations and three blind laminations $f_p = 0.854$. Through the electric connection between the parallel branches, large currents will flow in the middle parts of the outer branches, and we obtain a larger value for the factor f_p . Hence, it follows that by substitution of the above values for f_p in the formula for P_{mean} an accurate calculation may be made.

The exciter winding must now be calculated in the same man-

ner as an ordinary field winding consisting of four parallel branches. The exciter voltage is equal to

$$P_e = 2 P_{max} = 2 f_p P_{max} \cos \alpha$$

or substituting the value for P_{max}

$$P_e = 2 f_p m \frac{\sqrt{2}}{\pi} P \sin \frac{b_1 + \beta}{\tau_h} \frac{\pi}{2} \cos \alpha$$

$$\text{thus, } P_e = 0.9 f_p m \sin \frac{b_1 + \beta}{\tau_h} \frac{\pi}{2} P \cos \alpha$$

The potential curve $P_{max} \sin \alpha$ gives rise to cross currents in the field winding. Since the magnetizing effects of these currents neutralize each other, they need to be considered only in regard to their heating effect. Therefore, they must not be too great. In order that the compounding of this type of generator may remain as exactly as possible at all displacements of phase and loads, it is desirable that the electric resistance for the cross currents become equal to the resistance for the exciter currents.

e). *Commutator for asynchronous machines.*

If the commutator does not rotate in synchronism, but with a certain slip s , the mean potential curve rotates with a speed of rotation $s n_p$, corresponding to this slip. In a three-phase winding connected with the commutator, Fig. 60, a mean current will

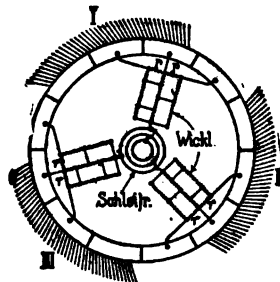

FIG. 60. ROTOR WINDING OF A COMPENSATED THREE-PHASE MOTOR WITH HEYLAND COMMUTATOR.

flow. This is three-phased and has the frequency c_s of the slip—

$$c_s = \frac{s p n_p}{60} = s \cdot c$$

If such a commutator is mounted on an asynchronous machine, the latter retains this property and works near synchronism with—

out running synchronously. The reactance x_s of the rotor winding for the mean current, which proceeds from the sinusoidal potential curve, is naturally proportional to the slip s . The mean voltage of phase of the rotor winding is —

$$P_{ph} = 0.45 f_p m \sin \frac{b_1 + \beta}{\tau_p} \frac{\pi}{2} P.$$

f). Conditions for sparkless commutation.

Let us consider the moment at which the brushes take the position relatively to the connected laminations indicated in Fig. 61.

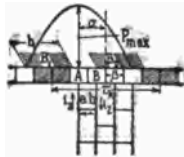

FIG. 61. THE MOMENT IN WHICH THE INTERNAL CURRENT i_s IS INTERRUPTED.

It is obvious that a large cross current i_s flows through the coils a and b . This disappears if the commutator moves to the right. Since both coils a and b , even if they are directly shunt-wound, still possess a considerable stray flux, at the disappearance of the current i_s , an electromagnetic energy $\frac{i_s^2 S}{2}$ is released. At the moment when the brush B_1 leaves the lamination A , the potential difference between the brushes B_1 and B_2 is

$$\Delta p = 2 \sqrt{2} P \sin \frac{\pi}{m} \sin \left(\frac{b_1 + q \beta}{\tau_p} \frac{\pi}{2} \pm \alpha - \frac{\pi}{m} \right)$$

Where P indicates the effective voltage per phase of the current, q the number of the adjoining current-bearing segments and α the angle of displacement of the potential curve opposite to the middle point of the connected segments. m is the number of phases. This potential difference Δp generates the cross current i_s , equal to

$$i_{s \max} \approx \frac{\Delta p}{R_s}.$$

where R_1 is the effective resistance between the laminations A and B .

If we substitute this expression for i_{max} in the formula for the released energy and divide this by the width of the brushes

$$B \text{ and the time of cutting out of circuit } T_s = \frac{R_b}{100 \beta R_1 v_b}$$

we obtain the maximum spark energy.

$$F = 50 \frac{(\Delta p)^2 S v_b}{R_1 R_b} \leq 50 \text{ to } 75 \text{ watts.}$$

The condition for a good commutation, then, in Heyland commutators is expressed by

$$\frac{\Delta p^2 S v_b}{R_1 R_b} \leq 1 \text{ to } 1.5 \text{ watts.}$$

The effective resistance R_1 and the coefficient of stray field S may be most simply determined experimentally by sending an alternate current through the lamination A into the winding and receiving it from the lamination B . By measuring current, voltage and energy there results in the ordinary way R_1 and S .

In order to avoid the production of sparks at the brushes by the released electromagnetic energy, it is advisable to insert resistances r in the manner shown in Fig. 60. For this last case only a part of the released energy under the brush points is lost and, hence, gives rise to sparks.

20. MULTIFOLD REËNTRANT ARMATURE-WINDING FOR ALTERNATING-CURRENT MOTORS BY THE AUTHORS.

In alternating-current commutator machines, multifold reëntrant armature windings, so-called Weston windings, are often used in order to avoid a short-circuiting of the individual armature coils. If, however, a short-circuiting of the coils is to be completely avoided, the individual reëntrant windings must at times be cut out of circuit successively. This cutting out of circuit does not permit the armature winding to be completely used and readily produces sparks on the commutator.

In order to avoid cutting the individual branches of the current out of circuit in multifold reëntrant windings, we insert resistances between the individual windings. While the equi-potential connections in direct-current machines ought to have as small a resistance as possible, and serve for the avoidance of sparks

arising from unsymmetry of the winding, or of the magnetic field, these resistance connections ought to have so great a resistance that the additional currents produced by the short-circuiting of the armature coils will be kept within admissible limits. On the other hand, the resistances ought to be kept so small that the winding, whose segments are not touched by the brushes, should not be devoid of current.

In Fig. 62 we have three reëntrant spiral windings, A_1, A_2, A_3 , of which A_1 is connected with the segments k_1 , A_2 with the segments k_2 , and A_3 with the segments k_3 . The brush B may touch at most three segments. Its width is, therefore, somewhat less than the double width of one segment. At the position indicated in Fig. 62, the brush short-circuits a coil S_2 of the winding A_2 .

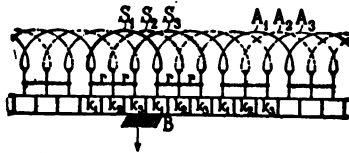

FIG. 62. WINDING WITH RESISTANCE CONNECTIONS.

Since, however, the short-circuit current can flow only through the two resistances r , the amount of it is limited by these resistances. The winding A_2 at this moment is not cut out as in the ordinary Weston windings, for through the many resistances r , which put all three windings into parallel circuit, a current from the brush B is carried to the winding A_2 . In order that no internal currents be produced in the three coils S_1, S_2 and S_3 , these coils, S_1, S_2 and S_3 , which are put into parallel circuit by the resistances r , as in the Heyland commutator, should lie in the same slots.

With this winding, the e.m.f. Δe , which generates the additional current, is induced in $\frac{p}{a} \frac{N}{K}$ wires, and, since the resistance r greatly outweighs both the resistance of the short-circuited coils R_s and the variable resistances R_x , one may write

$$i_{s \max} \approx \frac{\Delta e}{r}$$

The maximum spark energy is equal to

$$F = \frac{p i_{r \max}^2 S}{2 p_1 T_a B}$$

$$\text{where } T_a = \frac{R_b}{100 B r v_b} \text{ seconds.}$$

In order that no sparks be produced at the disappearance of the additional current, the energy should be—

$$\frac{F}{50} = \frac{p \Delta e^2 S v_b}{p_1 r R_b} \leq 1 \text{ to } 1.5 \text{ watts}$$

From this results the following formula for the calculation of the resistances r :

$$r \geq \frac{\Delta e^2 S v_b p}{(1 \text{ to } 1.5) R_b p_1}$$

Examples:

$$\Delta e = 20 \text{ volts}$$

$$S = \left(\frac{N}{K} \right)^2 \frac{k_a \lambda_N C_t}{2 \times 10^8} = 4^2 \frac{1 \times 7 \times 20}{2 \times 10^8} = 1.12 \times 10^{-5}$$

$$v_b = 12 \text{ meter/sec}$$

$$R_b = 0.18 \Omega$$

$$\text{So } r \geq \frac{20^2 \times 0.56 \times 10^{-5} \times 12}{(1 \text{ to } 1.5) 0.18} = 0.35 \text{ to } 0.2 \Omega$$

Assuming r at 0.4 ohm, we obtain

$$i_{r \max} \approx \frac{20}{0.4} = 50 \text{ amperes}$$

$$\text{and } \frac{F}{50} = \frac{20^2 \times 1.12 \times 10^{-5}}{0.4 \times 0.18} = 0.62 \text{ watt}$$

If one should insert such a large resistance r in the connections between armature winding and commutator, the main current would cause very great losses in them and the efficiency of the motor would fall away appreciably. In the winding proposed by us, the armature copper is not entirely used, because one branch of the current is circuited at times only through the many resistances. However, the mean conductance of such an armature winding amounts to 85 to 90 per cent of the total conductance of all branches of the current. The losses in the armature copper are therefore increased by these windings only about 10 to 15 per cent.

EXPLANATION OF SYMBOLS USED IN THE FORMULAS.

A = time constant ≥ 1 .

AS = current per cm periphery, or specific load of the armature.

$A W_a$ = ampere-turns of two auxiliary poles.

$A W_i$ = ampere-turns for the magnetic circuit of two auxiliary poles.

$A W_f$ = ampere-turns of the air-space.

$A W_p$ = ampere-turns for two pole-tips.

$A W_c$ = cross-magnetizing ampere-turns.

$A W_z$ = ampere-turns of the teeth.

a = one-half of the branches of the armature current.

B = length of all brushes of one brushholder.

B_s = strength of the resulting field with load.

B_f = induction in the air-space.

B_N = The slot field reduced to the armature surface.

B_o = strength of field with light load at a given point x of the neutral zone.

b_r = the width of the brushes reduced to the armature periphery.

b_1 = the width of one brush measured on the periphery of the collector.

$\omega = \frac{p n_p}{60}$, frequency of the supplied current.

ω_s = frequency of the slip of a polyphase commutator machine.

$\omega_r = \frac{p n}{60}$, frequency of rotation.

e_s = the e.m.f. induced with load in a short-circuited coil.

e_r = the e.m.f. induced in a repulsion motor by the main field in the short-circuited armature coil at a given speed of rotation.

e_e = effective e.m.f. which is induced in an armature coil of a polyphase commutator machine by the main field.

e_v = voltage drop due to a current, i_r .

F = released energy per cm width of brushes.

F_b = pressure area of all brushes in cm^2 .

F_h = area of the brushes of one holder in cm^2 .

f_s = form factor of the potential curve under the brushes.

- g = pressure of the brushes on the commutator in Kg per cm^2 .
 I = armature current.
 I_d = direct current of a converter.
 i_a = additional current.
 $i_{a \text{ max}}$ = maximum additional current.
 K = number of segments of the commutator.
 k_p = ratio between the pulsating and constant energy of a converter.
 k_s = factor < 1 for the calculation of the coefficient of self-induction.
 k_i = coefficient for the determination of the maximum additional current.
 l = length of the armature iron.
 l_i = reduced length of iron of the armature.
 l_s = length of the coil head of a winding.
 m = number of phases.
 N = number of wires on an armature.
 n_D = synchronous speed of the fundamental field of the stator winding of a polyphase commutator machine.
 n = speed of rotation of a rotor.
 P_{max} = amplitude of the curve of the mean potential on the commutator.
 P_{ph} = mean phase voltage of the rotor.
 p = number of pairs of poles.
 p_a = number of pairs of poles of the asynchronous machine of a cascade converter.
 p_b = brush potential in the Heyland commutator.
 p_g = number of pairs of poles of the direct-current machine of a cascade converter.
 q = the number of the adjoining current-bearing segments of the Heyland commutator.
 $R_n = \frac{\Delta P}{2 s_{\text{use}} g}$ = specific resistance of transition between brush and commutator.
 R_c = resistance of the connecting wires of the commutator.
 R_x = variable resistance of the circuit of a short-circuited current.
 R_i = constant resistance of the circuit of a short-circuited current.

r = resistance between the parallel branches of a multi-fold reëntrant winding of direct current.

S = Coefficient of apparent self-induction or coefficient of stray induction.

s = slip.

s_m = mean density of current under the brushes.

s_{avg} = effective density of current under the brushes.

s_a = density of current, caused by the additional current under the brush tips.

T = time duration of the short-circuit of a coil in seconds.

$T = \frac{1}{\sigma} =$ time of a cycle.

T_a = time of the disappearance of the additional current.

T_m = time in seconds from the beginning of the short-circuit to the moment when the additional current is at maximum.

t_1 = distance between slot centers.

v = surface velocity of the armature.

v_D = surface velocity of the rotary field.

v_b = surface velocity of the commutator.

W_r = frictional loss on the commutator.

W_u = loss by transition of current under the positive and negative brushes.

$\beta_r = \beta \frac{D}{D_b} =$ width of the commutator segments reduced to the periphery of the armature.

ΔP = drop of voltage under the brushes.

Δe = maximum e.m.f. induced between the brush tips.

$\Delta p = \Delta e - e_r =$ maximum potential difference between the brush tips.

δ = air-space.

λ_N = magnetic conductivity per cm length of the slot.

λ_a = specific conductivity of the armature field along the periphery of the armature.

τ = polar pitch.

τ_b = polar pitch referred to the commutator.

Φ_N = slot field.

$\text{Cos } \varphi$ = power factor.

$\sqrt{\gamma} =$ ratio between the energy of a machine as converter and direct-current generator.

717

2-11-1

1000
net

530.5

I

TRANSACTIONS

OF THE

INTERNATIONAL ELECTRICAL
CONGRESS

ST. LOUIS, 1904

VOLUME I

ORGANIZATION OF CONGRESS
PROCEEDINGS OF GENERAL MEETINGS
PROCEEDINGS OF CHAMBER OF DELEGATES
TRANSACTIONS OF SECTION A — General Theory
TRANSACTIONS OF SECTION B — General Applications

FOUND IN LIBRA
OCT 21 1965

UNIVERSITY OF MICHIGAN



3 9015 06816 0699



