

*The*  
**BAIRD**  
**"TELEVISOR"**



*Price List*  
*of*  
**BAIRD**  
**B R A N D E D**  
**COMPONENTS**

133 LONG ACRE, LONDON, W.C.2

*Telephone:* TEMPLE BAR 5401

*Telegraphic Address:* "TELEVISOR, RAND, LONDON."

**The BAIRD 'TELEVISOR'**

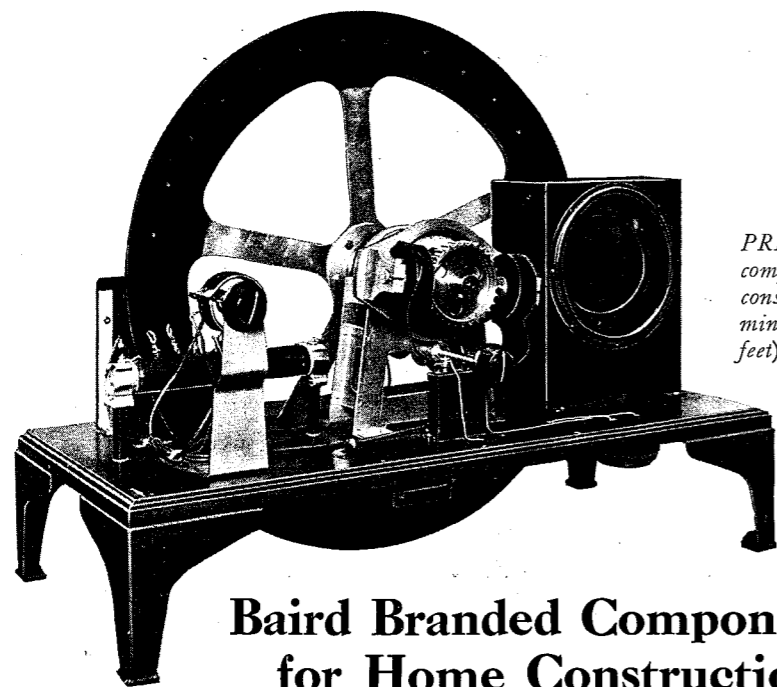

PRICE of Kit comprising components essential to home construction (excluding terminal board, base board and feet) .. £16 16s. 0d.

**Baird Branded Components for Home Construction**

**BAIRD SERVICE for the owners of BAIRD**

**" TELEVISORS "**

OWNERS of Baird Television Sets will be supported by an efficient service including a staff of trained service men. Should any owner get into difficulties, a telephone call or a postcard to his dealer will bring him technical advice. In return for the support we know we are getting from the public, we are prepared to give every possible assistance in installing, running and maintaining their "Televisors."

IN addition to the "Televisor" Home Reception Set we can supply complete range of Baird branded parts for the home constructor. We can also provide any single part of the apparatus thus enabling the experimenter to build his own experimental apparatus.

We feel that all those who are keenly interested in television should know and definitely realise that Baird branded products are the only genuine television components. The successful reception of the Baird transmission is dependent upon the use of Baird instruments only. Perfect reception is then guaranteed.

What the great Marconi has done for wireless Baird has done for television. We, as producers of his apparatus, wish to ask our public to join us in furthering the cause of television by co-operating with us to ensure longer hours and better programmes to which end all television enthusiasts must work.

**BAIRD BRANDED COMPONENTS**

*for perfect reception*

**The BAIRD 'TELEVISOR'**

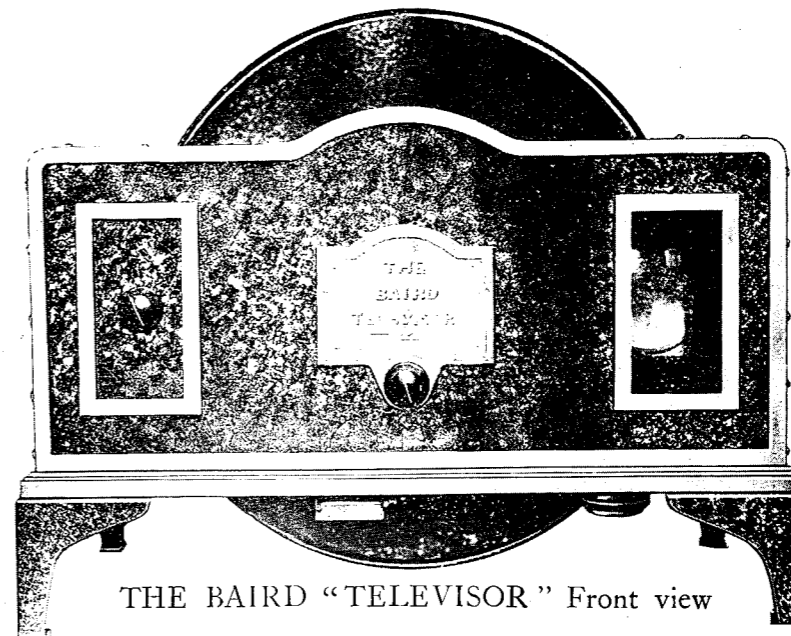

THE BAIRD "TELEVISOR" Front view

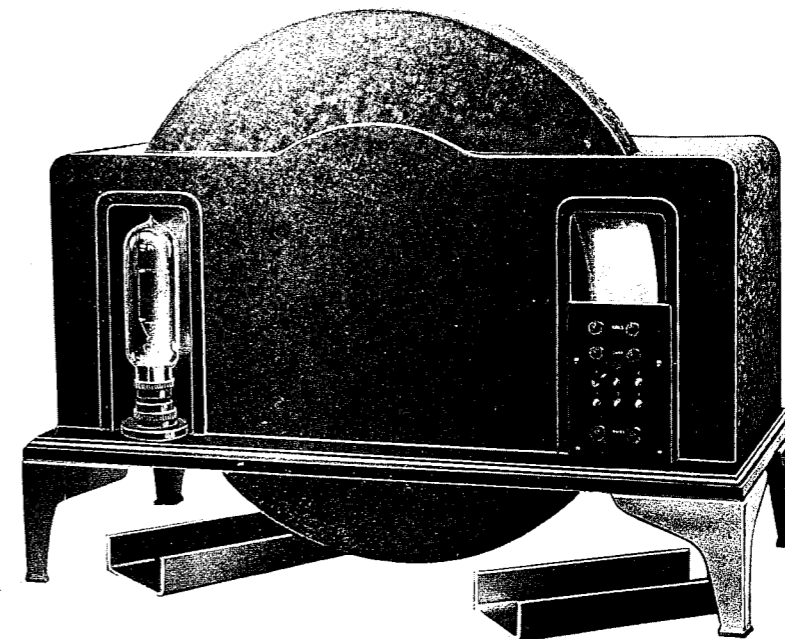

THE BAIRD "TELEVISOR" Back view

PRICE COMPLETE, Finished in Brown Metal Casing, Artistically Lined, £26 5s. 0d.

**BAIRD BRANDED COMPONENTS**

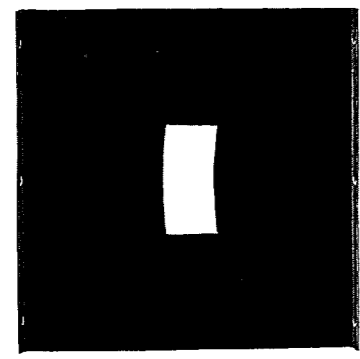

Lens Box Assembly (1)

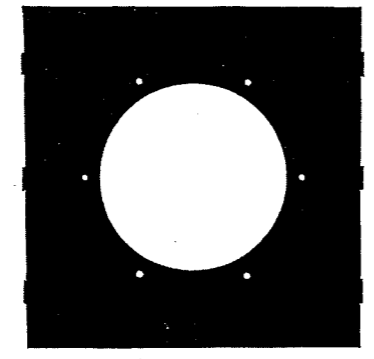

Lens Box Assembly (2)

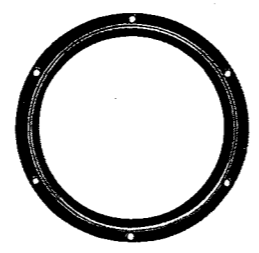

Lens Box Assembly (3)

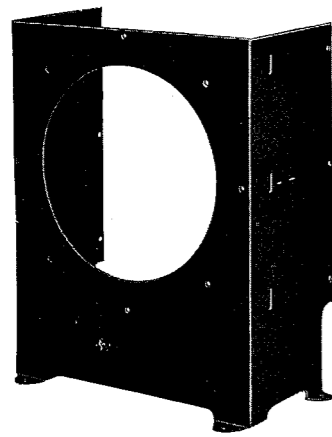

Lens Box Assembly (4)

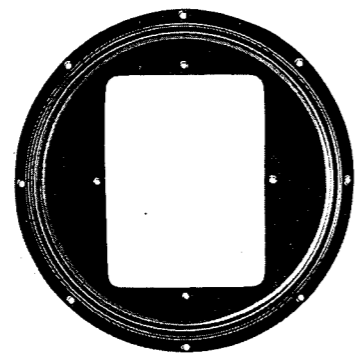

Lens Box Assembly (5)

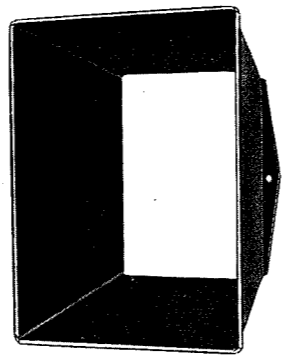

Lens Box Assembly (6)

THE SIX PIECES, Holes threaded to take No. 6 B.A. Screws, 24/-

Spindle

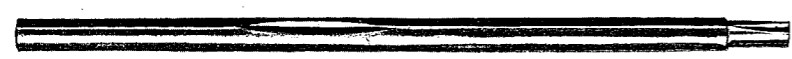

Collar



Pinion

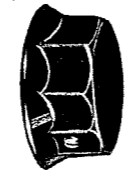

Knob

**SPINDLE ASSEMBLY**

PRICE, including Grub Screws and Control Knob, 5/9

**BAIRD BRANDED COMPONENTS**

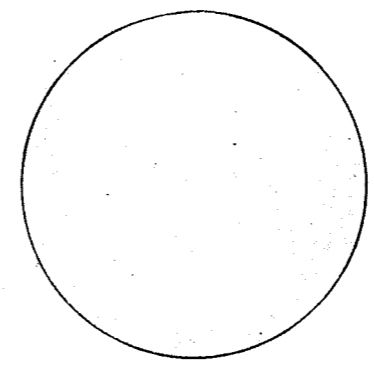

Lens (small) PRICE 7/6

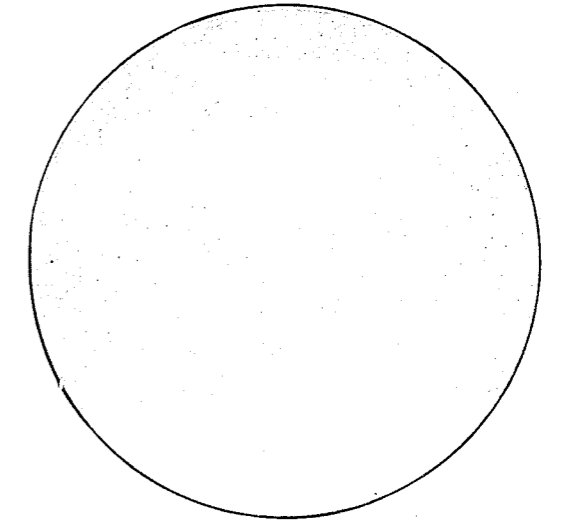

Lens (large) PRICE 13/6

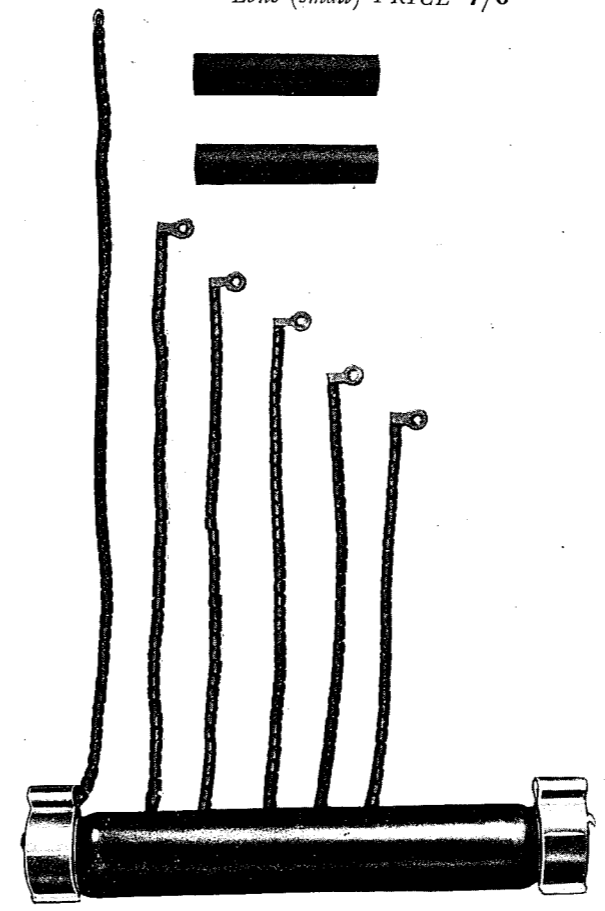

Zenite Resistance and Ebonite supports  
PRICE 17/-

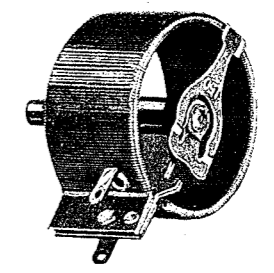

Variable Resistance  
and Bracket

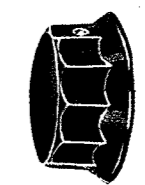

PRICE, including Control Knob, 6/3

# BAIRD BRANDED COMPONENTS

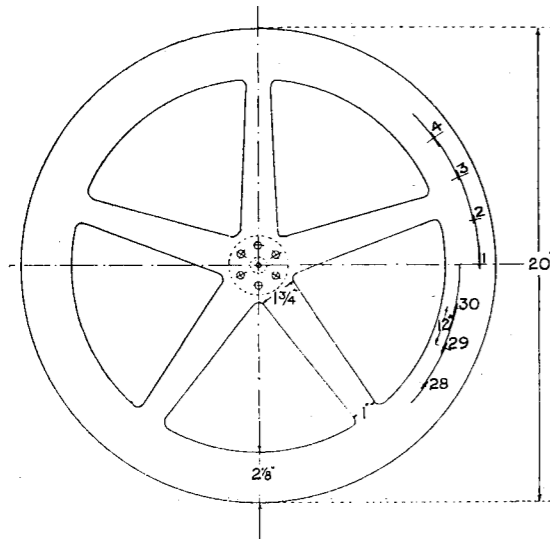

The Baird Graduated Receiving Disc  
PRICE £2 2s. 0d.



Flexible Lead and Adapter  
PRICE 5/6

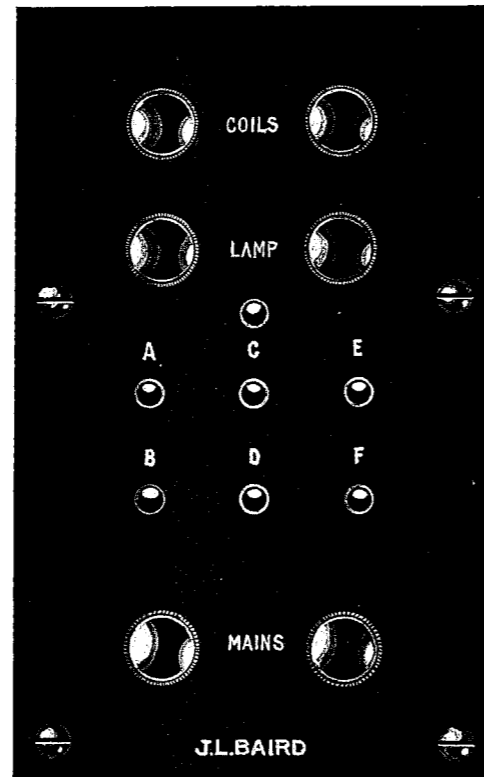

Terminal Board Assembly  
PRICE 9/6

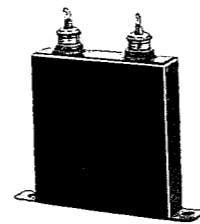

T.C.C. Condenser (Mica)  
PRICE 8/-

# BAIRD BRANDED COMPONENTS

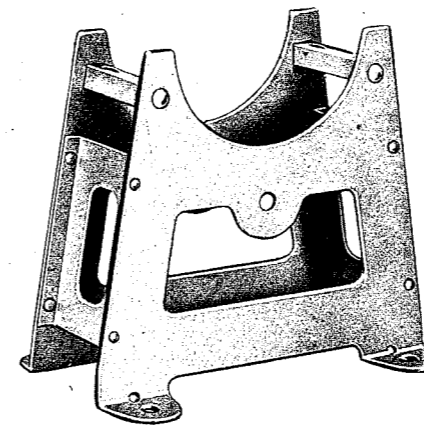
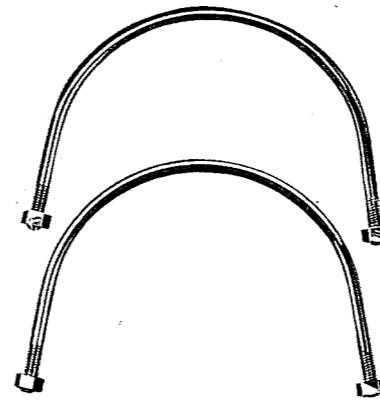

Strops and Motor Bracket  
Price complete with holding-down  
bolts and nuts £1 14 0

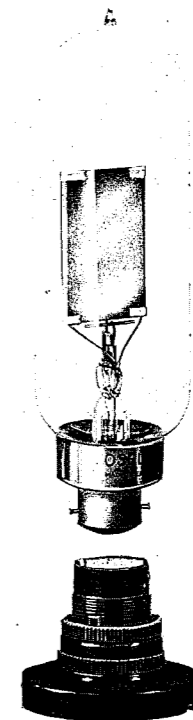

Flat Electrode Neon Tube £1 5 0  
Holder .. .. . 6 3

## The following are other Spare Parts not illustrated:—

Main Casing .. ..	£4 10 0
Well Casing .. ..	1 1 0
Neon Casing .. ..	2 6
Terminal Casing .. ..	3 4
Wood Base .. ..	18 6
Feet for Base (4) .. ..	11 0
Screws and Small Parts for Base Assembly .. ..	3 0
Screws, etc. (various) .. ..	3 0

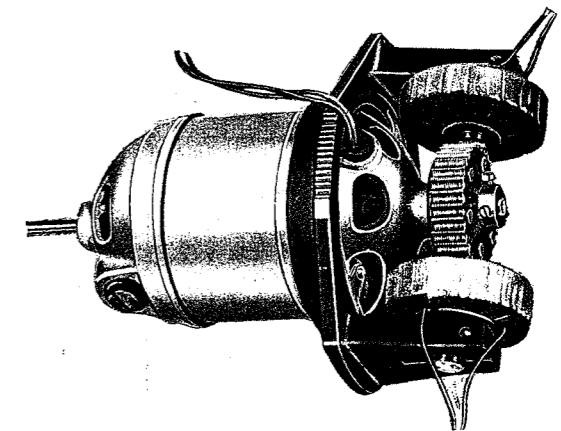

Universal Motor, complete with synchronising gear  
Price £7 7 0

# BAIRD BRANDED COMPONENTS

